

YAESU
The radio

144/430MHz
DUAL BAND FM TRANSCEIVER

FTM-6000R

FTM-6000E

Operating Manual

 Bluetooth®



Contents

Introduction	1	Scanning Function	26
About this manual	1	VFO Scan / Memory Scan / PMG Scan.....	26
Basic Operation	2	Programmable Memory scan (PMS).....	26
Turning the Transceiver ON	2	Setting the Receive Operation	
Adjusting the volume	2	When Scanning Stops.....	27
Adjusting the squelch level.....	2	Skip Memory Channels	27
Selecting a Frequency Band	2	Convenience Features	28
Tuning to a Frequency.....	3	Bluetooth® Operation	
Transmitting	3	(Requires optional BU-4).....	28
Locking the Keys and DIAL knob	3	Changing the Frequency Step.....	33
E2O-III (Easy to Operate-III) Provides the		Changing the Transmit Power Level	33
Choice of 3 Operating Modes to assign		Tone squelch feature.....	34
Functions & Settings	4	Digital Code squelch (DCS) feature.....	34
[F1] key.....	4	PAGER (EPCS) feature.....	34
Function List	4	Automatic Range Transponder System	
Menu List (see page 6).....	4	(ARTS).....	34
MAG (Memory Auto Grouping) function	5	Using Menu List	35
PMG (Primary Memory Group) function	5	Menu List Operation	35
VFO Band Skip function	5	Tables of Menu list Operations	36
Moving Memory Data to the VFO register ...	5	Restoring to Defaults (All Reset)	38
Supplied Accessories and Options	7	Specifications	39
Supplied Accessories.....	7	YAESU LIMITED WARRANTY	41
Available Options.....	7		
Name and function of each component	8		
Panel (front).....	8		
Panel (Rear, Left and right side).....	11		
Main body (Front and Rear)	11		
Microphone (SSM-85D)	12		
Safety Precautions (Be Sure to Read)	13		
Installing the Radio	15		
About the antenna	15		
Connection of Antenna and Power Cables ..	15		
Installing the transceiver	16		
Connecting the front panel to the			
main body	16		
Repeater Operation	17		
Communicating Via the Repeater	17		
Using the Memory	18		
Writing to memory	18		
Recall memory	19		
Recall only memories in the			
same frequency band (Band) using the			
memory auto grouping (MAG) function.....	20		
PMG (Primary Memory Group).....	21		
To Append an Alpha-numeric			
“Tag” to a Memory	22		
Clearing Memories	23		
Copying Memories	23		
Recalling the Home Channel	24		
Changing the Home Channel Frequency....	25		

Features of the Yaesu FTM-6000R/E Transceiver.

- New “E2O-III (Easy to Operate-III)” implements 3 function lists to allow calling up frequently used settings during operation with a single touch.
- The PMG (Primary Memory Group) function allows recalling a group of registered frequencies regardless of frequency band.
- Memory Channel Band Auto Grouping (MAG). The memory channels are automatically categorized in each band, so that memory channels can be easily and quickly recalled.
- Wide-band reception (108 MHz to 999.995 MHz) (USA Cellular Blocked)
- When the optional BU-4 Bluetooth® Unit is installed, supports hands-free communication using the optional Bluetooth® headset SSM-BT10 or a commercially available product.
- Large-capacity 1100 memory channels
- 3W Audio Power Speaker
- Heavy Duty-Heat Sink with FACC (Funnel Air-Convection Conductor)

Thank you for purchasing the FTM-6000R/E Transceiver. We urge you to read this manual in its entirety, and also the Advance Manual (available for download on the Yaesu website), to gain a full understanding of the amazing capability of the exciting new FTM-6000R/E Transceiver.

About this manual

The following notation is also used in this manual.



This icon indicates cautions and information that should be read.



This icon indicates notes, tips and information that should be read.

PLEASE NOTE: Due to product improvements, some of the illustrations in the instruction manual may differ from the actual product.

Basic Operation

Turning the Transceiver ON

1. Press and hold the Power (Lock) switch to turn the transceiver ON.

● Turning the transceiver OFF

Press and hold the Power (Lock) switch again to turn the transceiver OFF.

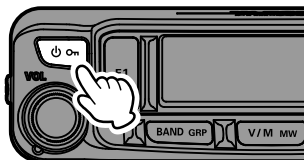

Adjusting the volume

1. Rotate the DIAL knob to adjust the volume to a comfortable level.

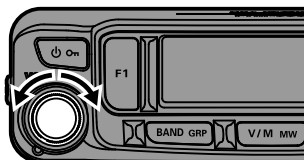

Adjusting the squelch level

Annoying noises can be muted when a signal cannot be detected. Normally, use the factory settings, but adjust the squelch if noise is harsh.

1. Press the [SQL BACK] key, and then rotate the DIAL knob to adjust to a level at which the background noise is muted.
2. After the adjustment, press the [SQL BACK] key again, or do nothing for about 2 seconds, the SQL meter will return to the normal screen.

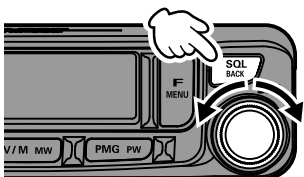

When the squelch level is increased, the noise is more likely to be silenced, but it may become more difficult to receive weak signals.

Selecting a Frequency Band

Press the [BAND GRP] key to select the desired frequency band.

AIR Band	108MHz - 137MHz
144MHz Band	137MHz - 174MHz
VHF Band	174MHz - 400MHz
430MHz Band	400MHz - 480MHz
UHF Band	480MHz - 999.995MHz

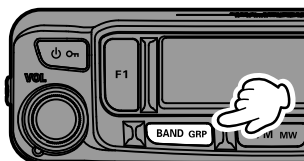

Unwanted frequency bands can be set in the menu list so they are not displayed. Press and hold the [F MENU] key → Rotate the DIAL knob to select [18 BND.SEL] → Press the DIAL knob → Rotate the DIAL knob to select a band → Press the DIAL knob → Rotate the DIAL knob to select ON or OFF.

Tuning to a Frequency

● DIAL knob

Rotating the **DIAL** knob changes the frequency in the optimal frequency step for the current frequency band.

Change frequency in 1MHz steps

Press the **DIAL** knob, and then rotate the **DIAL** knob.

Change frequency in 5MHz steps

Press and hold the **DIAL** knob, and then rotate the **DIAL** knob.

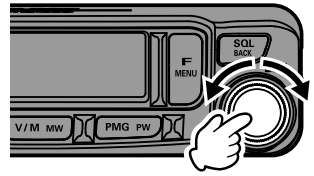

● The numeric keys on microphone

Press the numeric keys "0" to "9" to enter the frequency.

Example: To input 145.520MHz

[1] → [4] → [5] → [5] → [2]

Example: To input 430.000MHz

[4] → [3] → [Press and hold any numeric key]



While entering a frequency using the numeric keys, the entry may be canceled by pressing the **PTT** switch.

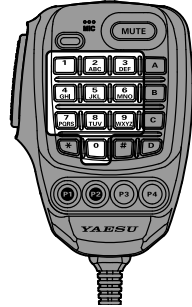

Transmitting

1. While pressing and holding the **PTT** switch, speak into the microphone. When transmitting, the "**TX**" icon appears on the display.
2. Release the **PTT** switch to return to receive mode. When receiving a signal, the "**BUSY**" icon appears on the display.

- If the PTT switch is pressed when a frequency other than an amateur ham radio band is selected, an alarm tone (beep) will be emitted and "Inhbt" appears on the display, disabling transmission.
- If transmission is continued for a long period, the transceiver overheats, and the high temperature protection function is activated. As a result, the transmitting power level is automatically set to Low Power. If transmission continues while the high temperature protection function is active, the transceiver will be forcibly returned to the receive mode.

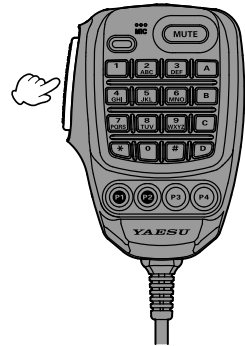

Locking the Keys and DIAL knob

1. Press the Power (Lock) switch, "**LOCK**" is shown on the display for one second, and then the keys and **DIAL** knob are locked.



The **PTT** switch and the **VOL** knob cannot be locked.

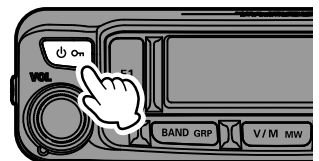

2. Press the **POWER** (Lock) switch again, "**UNLOCK**" is shown on the display and the keys and the **DIAL** knob are unlocked.

E2O-III (Easy to Operate-III) Provides the Choice of 3 Operating Modes to assign Functions & Settings

- ① “[F1] key” assigns the most frequently used function.
- ② “Function list” assigns frequently used functions.
- ③ “Menu list” to make all settings.

① [F1] key

From the list, the function with the highest priority can be registered to the [F1] key, then it can be called directly by simply pressing the [F1] key.

• Change the assignment of the [F1] key

Select the function or item to assign from the function list, then press and hold the [F1] key.

Press and hold: Assign to [F1] key

Press briefly: Recall and execute

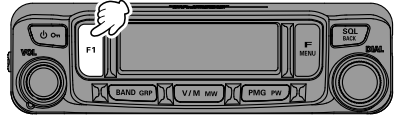

② Function List

Register frequently used items from the 34 functions on the menu list (see page 6). To recall a function, press the [F MENU] key, then turn the **DIAL** knob.

• Registration to function list

Select the function or item to assign from the menu list, then press and hold the [F MENU] key.

• Cancel registration to function list

Select the function or item to cancel, then press and hold the [SQL BACK] key.

The function is canceled from the function list and returns to the menu list.

Press and hold: Assign to Function List

Press briefly: Recall the Function List

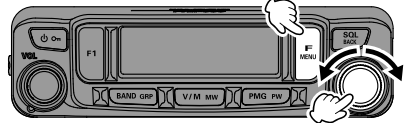

Rotate the DIAL knob to select

Press and hold: Unregister the Function



③ Menu List (see page 6)

To select all functions and items other than those registered to the frequently used function list, press and hold the [F MENU] key, then rotate the **DIAL** knob.

Press and hold: Recall the Menu List

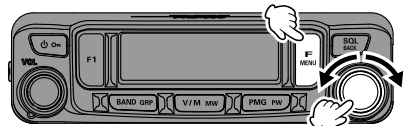

Rotate the DIAL knob to select

④ MAG (Memory Auto Grouping) function

Memory channels can be easily grouped and recalled by band. Each time the [BAND GRP] key is pressed while operating in memory mode, the bands are switched in the order illustrated below. Only the memory channels in that frequency band can be automatically grouped and recalled.

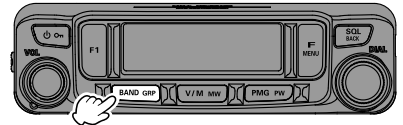

Press in memory mode to switch bands

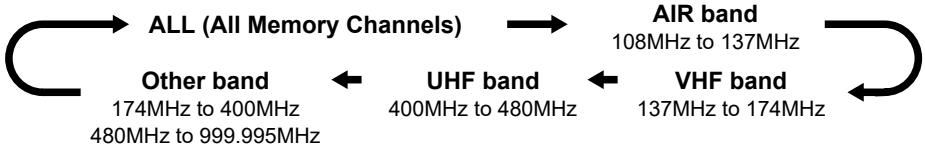

⑤ PMG (Primary Memory Group) function

Frequently used frequencies that have been registered in PMG, can be displayed in an easy-to-understand manner simply by pressing the [PMG PW] key.

• Register the frequency to PMG

Set the frequency, or the memory channel to register, then press and hold the [PMG PW] key to register it in PMG.

• Unregister the channel (frequency) registered in PMG

During PMG operation, select the frequency (channel) to be unregistered, then press and hold the [PMG PW] key to cancel the registration of that frequency.

Rotate the DIAL knob to select

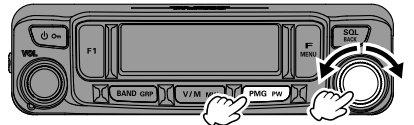

Press and hold: Register or Unregister
Press briefly: Enable or Disable PMG



Up to 5 channels can be registered in PMG. To register a new frequency, cancel one of the registered frequencies and then register the new frequency.

⑥ VFO Band Skip function

The VFO band selection is enabled by pressing the [BAND GRP] key. Also, unused bands may be skipped.

• Set the band to be skipped

Press and hold the [F MENU] key → Rotate the **DIAL** knob to select [18 BND. SEL] → Press the **DIAL** knob → Rotate the **DIAL** knob to select a band → Press the **DIAL** knob → Rotate the **DIAL** knob to select ON or OFF.

Press and hold: Recall the Menu List

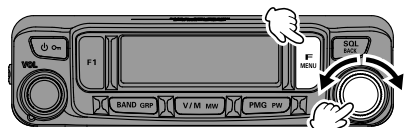

Rotate the DIAL knob to select

⑦ Moving Memory Data to the VFO register

The contents of the currently selected Memory Channel may be transferred into the VFO register. Press and hold the [SQL BACK] key while the memory channel is displayed.

Press and hold: Memory Channel transfer into the VFO

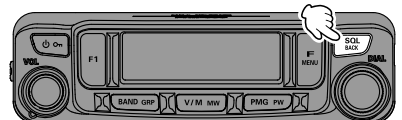

Menu List

The items in the gray are pre-registered in the "Function list", Press the **[F MENU]** key to call the "Function list".

01 APO	Enables/Disables the Automatic Power Off feature.
02 AR MOD	Select the ARTS Beep mode.
03 AR INT	Select the Polling Interval during ARTS operation.
04 BCLO	Enables/Disables the Busy Channel Lock-Out feature.
05 BEEP	Set the beep level.
06 BELL	Select the CTCSS/DCS/EPCS Bell Ringer repetitions.
07 CLK.TYP	Shifts of the CPU clock frequency.
08 DIMMER	Set the front panel display illumination level.
09 DTMF	Enables/Disables the DTMF Autodialer feature.
10 DT TX	Load the DTMF Autodialer Memories.
11 DT MEM	Register a DTMF code.
12 HOME	Recall the home channel.
13 MIC.GIN	Adjust the microphone gain level.
14 MIC.PGM	Program the functions assigned to the Microphone keys [P1] , [P2] , [P3] & [P4] .
15 PAGER	Set the Receive/Transmit Pager Code for Enhanced CTCSS Paging & Code Squelch functions.
16 PKT.SPD	DATA communication baud rate settings.
17 RX MODE	Select the receive mode.
18 BND.SEL	Set the frequency bands that can be selected.

19 RPT.REV	Reverses the transmit and receive frequencies while working through a repeater.
20 RPT.SET	Set the Repeater Shift direction.
21 RPT.OTR	<ul style="list-style-type: none"> • Set the ARS (Automatic Repeater Shift). • Set the Repeater Shift.
22 SCN.ON	Engages the Scan operation.
23 SCN.TYP	<ul style="list-style-type: none"> • Select the Scan Resume mode. • Set the "Dual Watch Revert" feature.
24 SQL.TYP	Selects the Tone Encoder and/or Decoder mode.
25 SQL.COD	Set the CTCSS Tone Frequency or DCS code.
26 SQL.EXP	Enable or disables split CTCSS/DCS coding.
27 STEP	Set the frequency synthesizer steps.
28 xx.xF (C)	Display the current temperature inside the transceiver.
29 TOT	Set the Time-Out Timer.
30 TX PWR	Set the transmit power level.
31 VER.DSP	Display the transceiver software version.
32 xx.xV	Display the DC Supply Voltage.
33 WIDTH	Set the FM transmit modulation level and receiver bandwidth.
34 WX ALT	Weather alert operation setting.
35 BLT	Set the Bluetooth function.

Supplied Accessories and Options

Supplied Accessories

- DTMF microphone SSM-85D
- DC power cable (with fuse attached)
- Control cable
- Control cable 10ft (3m)
- Bracket for main body
- Bracket for the controller
- USB Cable
- Spare fuse (15A)
- Operating Manual (This Manual)



If any item is missing, contact the dealer from which you purchased the transceiver.

Available Options

- | | |
|--|----------|
| • DTMF Microphone | SSM-85D |
| • Microphone | MH-42C6J |
| • Bluetooth® Headset | SSM-BT10 |
| • Bluetooth® Unit | BU-4 |
| • High-Power External Speaker | MLS-100 |
| • Vacuum Cup Mount Bracket for Front Panel Controller | MMB-98 |
| • Mic Extension Kit 10ft (3m) for SSM-85D and MH-42C6J | MEK-5 |
| • Control Cable 20ft (6m) | SCU-47 |
| • Cloning Cable | CT-166 |
| • Data Cable (MDIN10 pin to MDIN6 pin + Dsub9) | CT-163 |
| • Data Cable (MDIN10 pin to MDIN6 pin) | CT-164 |
| • Data Cable (MDIN10 pin to Open) | CT-167 |

Name and function of each component

Panel (front)

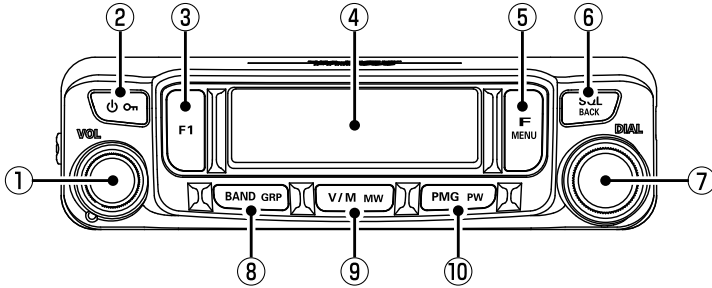

① VOL knob

Rotate the VOL Knob to adjust the audio volume level.

② POWER (On) Switch

Press and hold this button to switch the power ON or OFF.

When the power is ON, press this button briefly to engage, or release the key lock.

③ [F1] key

The [F1] key is user programmable, allowing quick access to the Function or Menu item that is most often used. The factory default setting is "HOME" (calls the home channel).

To change to another item, press the [F MENU] key, and then rotate the DIAL knob to select the desired item, and press and hold the [F1] key.

④ LCD display

1~5 : PMG Memory Number

F : Function List

R : AIR band*¹ memory channels only

V : VHF band*² memory channels only

U : UHF band*³ memory channels only

O : Other band*⁴ memory channels only

*¹ 108MHz to 137MHz

*² 137MHz to 174MHz

*³ 400MHz to 480MHz

*⁴ 174MHz to 400MHz

480MHz to 999.995MHz

001~999 : Memory Channel Number

LO1~US0 : Programmable Memory Channel Number

PO1~PS0 : Programmable Memory Scan

HM : HOME Channel

PM : PMG Memory

DCS (Digital Code Squelch)

Repeater Shift Direction

CTCSS Operation

Memory Mode

- Frequency/Message area
- Memory Tag area
- Menu List
- Function List



Transmission in Progress

Bluetooth function

Appears: Bluetooth Device is connected

Blinks: Bluetooth Device not connected

⑤ **[F MENU] key**

Press briefly

Press the **[F MENU]** key to display the function list screen. Rotate the **DIAL** knob to select an item and perform the functions and make settings.

In the factory default setting, the items in gray of the table below are registered to the function list. The registration can be canceled at any time.

Add registration: Press and hold the **[F MENU]** key → Turn the **DIAL** knob to select the item to register → Press and hold the **[F MENU]** key.

Cancel registration: Turn the **DIAL** knob to select the registered item to cancel → Press and hold the **[SQL BACK]** key.

Press and hold

Press and hold the **[F MENU]** key to enter the menu list. The Menu list permits configuring the various functions according to individual operating needs and preferences. (Refer to page 35).

The items in gray are registered to the “function list” in advance, briefly press the **[F MENU]** key to call them.

Menu list

01 APO	Enables/Disables the Automatic Power Off feature.
02 AR MOD	Select the ARTS Beep mode.
03 AR INT	Select the Polling Interval during ARTS operation.
04 BCLO	Enables/Disables the Busy Channel Lock-Out feature.
05 BEEP	Set the beep level.
06 BELL	Select the CTCSS/DCS/EPCS Bell Ringer repetitions.
07 CLK.TYP	Shift the CPU clock frequency.
08 DIMMER	Sets of the front panel display illumination level.
09 DTMF	Enables/Disables the DTMF Autodialer feature.
10 DT TX	Loads the DTMF Autodialer Memories.
11 DT MEM	Register a DTMF code.
12 HOME	Recall the home channel.
13 MIC.GIN	Adjust the microphone gain level.
14 MIC.PGM	
PGM.P1	Program the function assigned to the Microphone [P1] key.
PGM.P2	Program the function assigned to the Microphone [P2] key.
PGM.P3	Program the function assigned to the Microphone [P3] key.
PGM.P4	Program the function assigned to the Microphone [P4] key.
15 PAGER	
PAG.CDR	Set the Receive Pager Code for Enhanced CTCSS Paging & Code Squelch functions.
PAG.CDT	Set the Transmit Pager Code for Enhanced CTCSS Paging & Code Squelch functions.
16 PKT.SPD	DATA communication baud rate settings.
17 RX MODE	Select the receive mode.
18 BND.SEL	Set the frequency bands that can be selected.

19 RPT.REV	Reverses the transmit and receive repeater offset frequencies.
20 RPT.SET	Set the Repeater offset frequency Shift direction.
21 RPT.OTR	
RPT.ARS	Activate/Deactivate the Automatic Repeater Shift feature.
RPT.FRQ	Set the magnitude of the Repeater Shift.
22 SCN.ON	Engages the Scan operation.
23 SCN.TYP	
SCN.RSM	Select the Scan Resume mode.
DW RVT	Enables/Disables the “Dual Watch Revert” feature.
24 SQL.TYP	Selects the Tone Encoder and/or Decoder mode.
25 SQL.COD	Setting of the CTCSS Tone Frequency or the DCS code.
26 SQL.EXP	Enables/Disables the split CTCSS/DCS coding.
27 STEP	Sets the frequency synthesizer steps.
28 xx.xF	Indicates the current temperature inside the transceiver.
29 TOT	Set the Time-Out Timer.
30 TX PWR	Set the transmit power level.
31 VER.DSP	Display the transceiver software version.
32 xx.xV	Display the DC Supply Voltage.
33 WIDTH	Set the FM transmit modulation level and receiver bandwidth.
34 WX ALT	Weather alert operation setting.
35 BLT	
BLT.OFF	Set the Bluetooth function.
BLT.LST	Bluetooth device list.
BLT.SAV	Set the Bluetooth save function.
BLT.AF	Set the Bluetooth receive audio output.

⑥ [SQL BACK] key

- Press the [SQL BACK] key, then rotate the DIAL knob to adjust the squelch level. The squelch level may be adjusted to mute the background noise when no signal is present.
- Press the [SQL BACK] key to return to the previous screen.
- If the [SQL BACK] key is pressed and held while the memory channel is displayed, the information registered in the memory channel at that time will be switched to VFO mode.

⑦ DIAL knob

Change the frequency or select the memory channel.

- Press the DIAL knob to enable setting the operating band frequency in 1MHz units.
- Press and hold the DIAL knob to enable setting the frequency in 5MHz units.
- Press the [SQL BACK] key, then rotate the DIAL knob to adjust the squelch level.

⑧ [BAND GRP] key

VFO mode





Each key press switches the operating frequency band.

Band	Selectable Frequency Range
AIR	108MHz - 137MHz
144MHz	137MHz - 174MHz
VHF	174MHz - 400MHz
430MHz	400MHz - 480MHz
UHF	480MHz - 999.95MHz

Memory mode

Each time the [BAND GRP] key is pressed, only memory channels of the same frequency band are automatically recalled as a group as shown below.

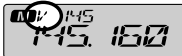
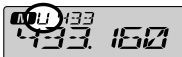
Bands that have not been stored are not displayed.

Group Name	Selectable Memory Channels
ALL No icon display 	All memory channels.
AIR "A" icon blink 	AIR band (108MHz to 137MHz) memory channels only.
VHF "V" icon blink 	VHF band (137MHz to 174MHz) memory channels only.
UHF "U" icon blink 	UHF band (400MHz to 480MHz) memory channels only.
Other "O" icon blink 	174MHz to 400MHz and 480MHz to 999.995MHz memory channels only.

⑨ [V/M mw] key

Press briefly

- Pressing each time switches between VFO mode and memory mode.
- When a memory channel is recalled, the "M" icon and the memory channel number are displayed, such as "001". The last operated memory channel is recalled.

Press and hold

Press and hold for over one second to write to memory.

⑩ [PMG pw] key

Press briefly

Each press each time switches between PMG (Primary Memory Group) mode and memory or VFO mode.

Press and hold

Press and hold for over one second to write to PMG memory.

Panel (Rear, Left and right side)

DATA jack

When updating the panel firmware, connect to the PC with the supplied USB cable.

Please refer to YAESU website for firmware updates.

CONTROL jack

Plug the control cable into this jack to connect with the main body.

Press to release the control panel from the transceiver.

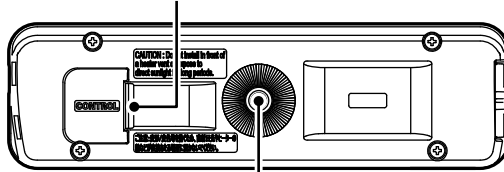
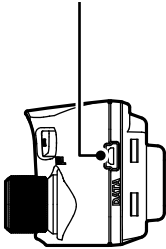

Attach the supplied panel bracket or the optional adjustable angle suction type control panel bracket MMB-98 with the supplied screws.

Main body (Front and Rear)

MIC jack

Connect the cable of the included DTMF microphone SSM-85D or the optional microphone MH-42C6J.

CONTROL jack

Plug the control cable into this jack to connect with the control panel.

DATA jack

When updating the Main firmware, connect to the PC with the supplied USB cable.

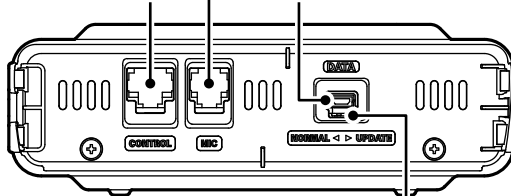

Connecting the front panel to the main body

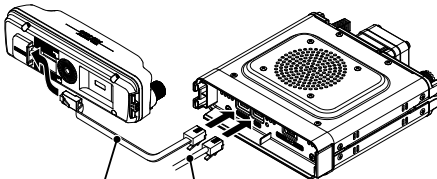

Control cable Microphone cable

Firmware Update switch

This switch is used when updating the Main firmware. Normally set to "NORMAL" position.

Please refer to YAESU website for firmware updates.

Connect the provided DC power supply cable (with fuse attached).

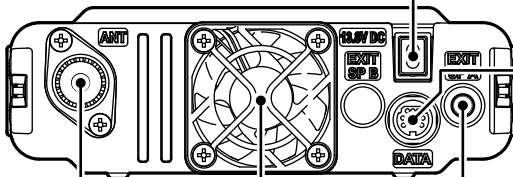

Connect the co-axial cable for the antenna.

Cooling fan

This 2-conductor, 3.5-mm mini phone jack provides audio output for an optional speaker. The optimum load impedance is 8 Ohms.

Microphone (SSM-85D)

① MIC

Speak into the microphone during transmission.

② TX LED

Lights red while pressing PTT switch.

③ PTT

Press and hold the PTT switch to transmit, and release it to receive.

④ DWN

Press this button to move the frequency or memory channel lower by one step, press and hold it to start scanning.

⑤ UP

Press this button to move the frequency or memory channel up by one step, press and hold it to start scanning.

⑥ MUTE

Press this button to mute the receive audio. Press it again to unmute the audio.

⑦ DTMF keypad

Press these keys during transmit to enter and send a DTMF sequence. The following operations can be performed during receive.

0 - 9 : Enter the frequency or memory channel number.

A : Change frequency in 1MHz steps

B : Adjust the squelch level.

C : Each key press switches between PMG (Primary Memory Group) mode and memory or VFO mode.

D : Each key press switches between Function list mode and memory or VFO mode.

* : Each press switches between VFO mode and memory mode.

: This key has the same function as the **[BAND GRP]** key on the controller.

VFO mode:

Each press changes the operating frequency band:

→ AIR (108MHz to 137MHz) → 144MHz (137MHz to 174MHz) → VHF (174MHz to 400MHz) →
→ 430MHz (400MHz to 480MHz) → UHF (480MHz to 999.995MHz) → AIR

Memory mode:

Each time the key is pressed only memory channels of the same frequency band are automatically recalled as a group, as shown below:

→ ALL → AIR (108MHz to 137MHz) → VHF (137MHz to 174MHz) → UHF (400MHz to 480MHz) →
→ Other (174MHz to 400MHz and 480MHz to 999.995MHz) → ALL

* Bands that have not been stored are not displayed.

⑧ Program keys (P1/P2/P3/P4)

The default function settings of the [P1] / [P2] / [P3] / [P4] keys are shown in the table below.

Key	Function	Description
P1	SQL OFF	Opens the squelch (SQL off)
P2	HOME	Recalls HOME channel
P3	SCN ON	Starts or stops the scanning function
P4	WX (T-CALL)	Switches operation to the Weather Channel Bank (T-CALL: European/Asian versions)

The functions of the [P1] - [P4] keys can be assigned by the following operations:

1. Press and hold the **[F MENU]** key.
2. Rotate the **DIAL** knob to select **[14 MIC.PGM]**, then press the **DIAL** knob.
3. Rotate the **DIAL** knob to select a key to assign a function **[PGM.P1] - [PGM.P4]** then press the **DIAL** knob.
4. Rotate the **DIAL** knob to select a function (see the table below) then press the **DIAL** knob.

Function	Description
ARTS	Starts or stops the ARTS function
SCN ON	Starts or stops the scanning function
HOME	Recalls the HOME channel
RPT.SFT	Sets the repeater shift direction
RPT.REV	Reverses the transmit and receive frequencies in repeater mode or split memory

Function	Description
TX PWR	Selects the transmit power output level
SQL OFF	Opens the squelch (SQL OFF)
T-CALL	Transmits the T-CALL (1750 Hz)
DW	Starts or stops the Dual Watch function
WX	Switches operation to the Weather Channel Bank

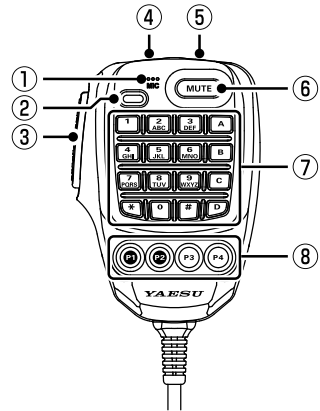

Safety Precautions (Be Sure to Read)

Be sure to read these important precautions, and use this product safely.

Yaesu is not liable for any failures or problems caused by the use or misuse of this product by the purchaser or any third party. Also, Yaesu is not liable for damages caused through the use of this product by the purchaser or any third party, except in cases where ordered to pay damages under the laws.

Types and meanings of the marks



DANGER

This mark indicates an imminently hazardous situation, which, if not avoided, could result in death or serious injury.



WARNING

This mark indicates a potentially hazardous situation, which, if not avoided, could result in death or serious injury.



CAUTION

This mark indicates a potentially hazardous situation, which, if not avoided, may result in minor or moderate injury or only property damage.

Types and meanings of symbols



These symbols signify prohibited actions, which must not be done to use this product safely. For example:  indicates that the product should not be disassembled.



These symbols signify required actions, which must be done to use this product safely. For example:  indicates that the power plug should be disconnected.



DANGER



Do not use the device in "regions or aircrafts and vehicles where its use is prohibited" such as in hospitals and airplanes.

This may exert an impact on electronic and medical devices.



Do not use this product while driving or riding a motorbike. This may result in accidents.

Make sure to stop the car in a safe location first before use if the device is going to be used by the driver.



Do not operate the device when flammable gas is generated.

Doing so may result in fire and explosion.



Never touch the antenna during transmission.

This may result in injury, electric shock and equipment failure.



Do not transmit in crowded places in consideration of people who are fitted with medical devices such as heart pacemakers.

Electromagnetic waves from the device may affect the medical device, resulting in accidents caused by malfunctions.



When an alarm goes off with the external antenna connected, cut off the power supply to this radio immediately and disconnect the external antenna from this radio.

If not, this may result in fire, electric shock and equipment failure.



Do not touch any liquid leaking from the liquid display with your bare hands.

There is a risk of chemical burns occurring when the liquid comes into contact with the skin or gets into the eyes. In this case, seek medical treatment immediately.



WARNING



Do not use voltages other than the specified power supply voltage.

Doing so may result in fire and electric shock.



Do not transmit continuously for long periods of time.

This may cause the temperature of the main body to rise and result in burns and failures due to overheating.



Do not dismantle or modify the device.

This may result in injury, electric shock and equipment failure.



Do not handle the power plug and connector etc. with wet hands. Also do not plug and unplug the power plug with wet hands.

This may result in injury, liquid leak, electric shock and equipment failure.



When smoke or strange odors are emitted from the radio, turn off the power and disconnect the power cord from the socket.

This may result in fire, liquid leak, overheating, damage, ignition and equipment failure. Please contact our company amateur customer support or the retail store where you purchased the device.



Keep the power plug pins and the surrounding areas clean at all times.

This may result in fire, liquid leak, overheating, breakage, ignition etc.





Disconnect the power cord and connection cables before incorporating items sold separately and replacing the fuse.

This may result in fire, electric shock and equipment failure.

 **Never cut off the fuse holder of the DC power cord.**
This may cause short-circuiting and result in ignition and fire.

 **Do not use fuses other than those specified.**
Doing so may result in fire and equipment failure.

 **Do not allow metallic objects such as wires and water to get inside the product.**
This may result in fire, electric shock and equipment failure.

 **Do not place the device in areas that may get wet easily (e.g. near a humidifier).**
This may result in fire, electric shock and equipment failure.

 **When connecting a DC power cord, pay due care not to mix up the positive and negative polarities.**
This may result in fire, electric shock and equipment failure.

 **Do not use DC power cords other than the one enclosed or specified.**
This may result in fire, electric shock and equipment failure.



 **Do not bend, twist, pull, heat and modify the power cord and connection cables in an unreasonable manner.**
This may cut or damage the cables and result in fire, electric shock and equipment failure.

 **Do not pull the cable when plugging and unplugging the power cord and connection cables.**
Please hold the plug or connector when unplugging. If not, this may result in fire, electric shock and equipment failure.

 **Refrain from using headphones and earphones at a loud volume.**
Continuous exposure to loud volumes may result in hearing impairment.

 **Do not use the device when the power cord and connection cables are damaged, and when the DC power connector cannot be plugged in tightly.**
Please contact our company amateur customer support or the retail store where you purchased the device as this may result in fire, electric shock and equipment failure.

 **Follow the instructions given when installing items sold separately and replacing the fuse.**
This may result in fire, electric shock and equipment failure.

 **Do not use the device when the alarm goes off.**
For safety reasons, please pull the power plug of the DC power equipment connected to the product out of the AC socket.
 Never touch the antenna as well. This may result in fire, electric shock and equipment failure due to thunder.

CAUTION

 **Do not place this device near a heating instrument or in a location exposed to direct sunlight.**
This may result in deformation and discoloration.

 **Do not place this device in a location where there is a lot of dust and humidity.**
Doing so may result in fire and equipment failure.

 **Stay as far away from the antenna as possible during transmission.**
Long-term exposure to electromagnetic radiation may have a negative effect on the human body.

 **Do not wipe the case using thinner and benzene etc.**
Please use a soft and dry piece of cloth to wipe away the stains on the case.

 **Keep out of the reach of small children.**
If not, this may result in injuries to children.

 **Do not put heavy objects on top of the power cord and connection cables.**
This may damage the power cord and connection cables, resulting in fire and electric shock.

 **Do not transmit near the television and radio.**
This may result in electromagnetic interference.

 **Do not use optional products other than those specified by our company.**
If not, this may result in equipment failure.

 **When using the device in a hybrid car or fuel-saving car, make sure to check with the car manufacturer before using.**
The device may not be able to receive transmissions normally due to the influence of noises from the electrical devices (inverters etc.) fitted in the car.

 **For safety reasons, switch off the power and pull out the DC power cord connected to the DC power connector when the device is not going to be used for a long period of time.**
If not, this may result in fire and overheating.

 **Do not throw or subject the device to strong impact forces.**
This may result in equipment failure.

 **Do not put this device near magnetic cards and video tapes.**
The data in the cash card and video tape etc. may be erased.

 **Do not turn on the volume too high when using a headphone or earphone.**
This may result in hearing impairment.

 **Do not place the device on an unsteady or sloping surface, or in a location where there is a lot of vibration.**
The device may fall over or drop, resulting in fire, injury and equipment failure.

 **Do not stand on top of the product, and do not place heavy objects on top or insert objects inside it.**
If not, this may result in equipment failure.

 **Do not use a microphone other than those specified when connecting a microphone to the device.**
If not, this may result in equipment failure.

 **Do not touch the heat radiating parts.**
When used for a long period of time, the temperature of the heat radiating parts will get higher, resulting in burns when touched.

 **Do not open the case of the product except when replacing the fuse and when installing items sold separately.**
This may result in injury, electric shock and equipment failure.

About the antenna

The antenna is an extremely important part for both transmitting and receiving. The antenna type and its inherent characteristics determine whether the performance of the transceiver can be fully realized. As such, please note the following:

- Use an antenna that is suitable for the installation conditions and application objective.
- Use an antenna that is suitable for the operating frequency band.
- Use an antenna and a coaxial cable with a characteristic feed point impedance of 50Ω .
- Adjust the VSWR (Voltage Standing Wave Ratio) until it is 1.5 or less for an antenna with an adjusted impedance of 50Ω .
- Keep the coaxial cable routing length as short as possible.

Connection of Antenna and Power Cables

Please follow the outline in the illustration regarding the proper connection of antenna coaxial cables and Power Supply.

Cautions

- Do not use a DC power supply cable other than the one that is provided.
- Do not use the DC power supply cable with the fuse holder cut off.
- Use an external power source capable of supplying DC 13.8 V, a current capacity of 15 A or more.

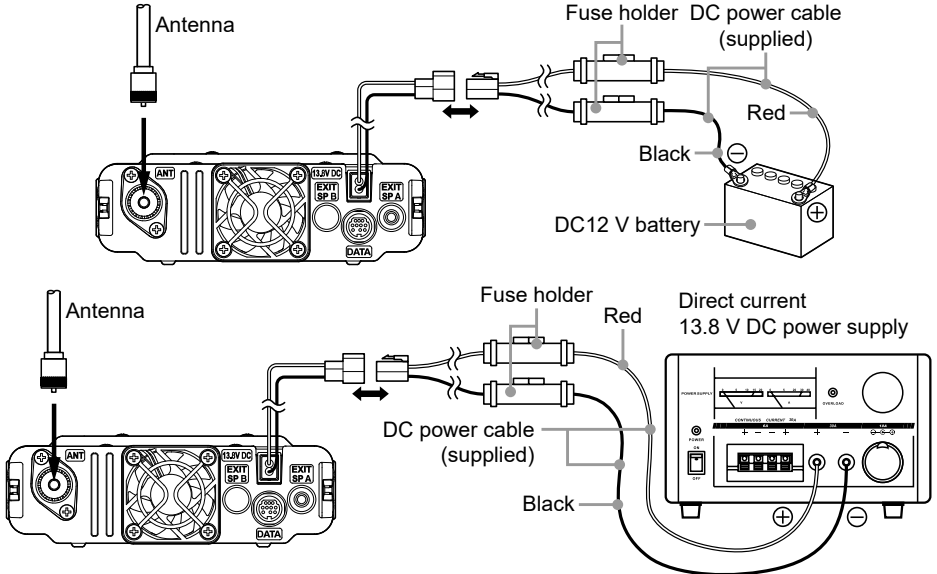

Installing the transceiver

Install the main body and the front panel using the supplied brackets.



- The bracket can be formed by hand to match the location where the front panel is installed.
- Be careful not to cause an injury when bending the bracket.

1. Select the installation location.

Caution : Select a location where the transceiver can be securely attached.

2. Drill four 6mm diameter holes in the location where the bracket is to be mounted, matching the positions of the bolting holes of the bracket.
3. Insert the grooves on both sides of the main body into the bracket until they click and lock. Tighten the screw against the lever to lock the transceiver in the bracket.
4. To remove the main body from the bracket, loosen the locking screw, and then pull the transceiver out while pressing the lever indicated by the arrow below.

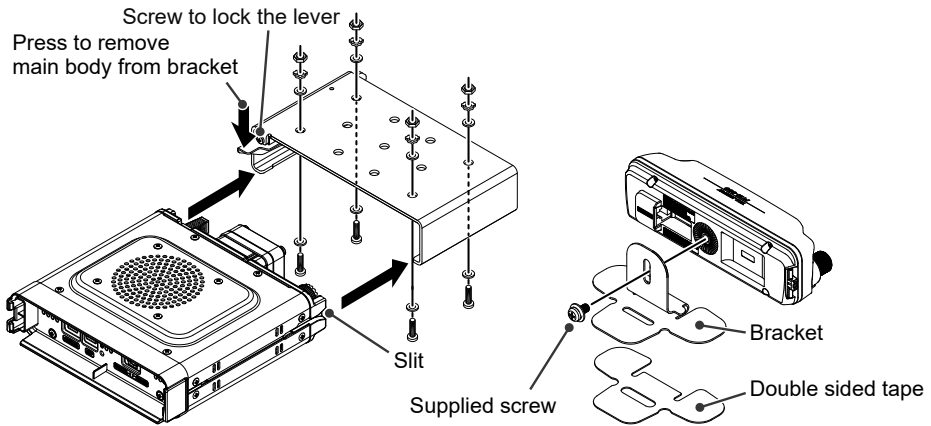

Connecting the front panel to the main body

Connect the transceiver to the “**CONTROL**” jack of the control panel with the included control cable. Connect the cable of the supplied microphone SSM-85D to the “**MIC**” terminal of the transceiver.

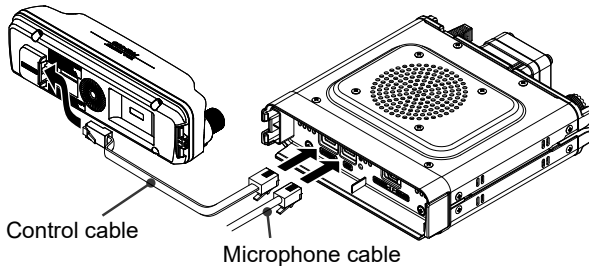

Communicating Via the Repeater

The transceiver includes an ARS (Automatic Repeater Shift) function which automatically sets the repeater operation when the receiver is tuned to the repeater frequency.

1. Set the receive frequency to the repeater frequency “-” or “+” icon appears on top of the display.
2. Speak into the microphone while pressing and holding the **PTT** switch.



● Reverse function

The “reverse” state temporarily reverses the transmit and receive frequencies. This allows checking to find if direct communication with the other station is possible.

1. Press the [**F MENU**] key.
2. Rotate the **DIAL** knob to select [**F-19 RPT.REV**], then press the **DIAL** knob.

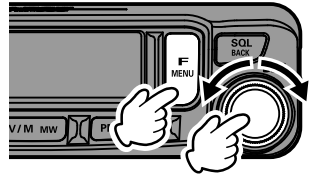

In the factory default setting, [**F-19 RPT.REV**] is registered in the “Function List” that is displayed when the [**F MENU**] key is pressed.

- The transmit and receive frequencies are temporarily reversed (“reverse” state).
- In the “reverse” state, the “-” or “+” blinks on the display.

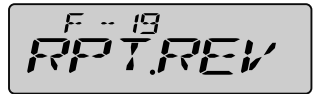

3. To release the reverse state, repeat the above steps again.

-
- The repeater settings may be changed from the Menu list.



- Function list [20 RPT.SET]: Allows setting the repeater shift direction.
 - Menu list [21 RPT.OTR] → [RPT.ARS]: The ARS function may be set to OFF
 - Menu list [21 RPT.OTR] → [RPT.FRQ]: Allows changing the repeater shift offset.
 - Menu list [25 SQL.COD]: CTCSS Tone frequency
-

● Tone Calling (1750 Hz)

If the transceiver is FTM-6000R/E (European/Asian versions), press and hold in the [**P4**] key on the microphone (in factory default setting) to generate a 1750 Hz burst tone to access the European repeater. The transmitter will automatically be activated, and a 1750 Hz audio tone will be superimposed on the carrier. Once access to the repeater has been achieved, release the switch, and thereafter use the switch for activating the transmitter. To access repeaters which require a 1750 Hz burst tone with the FTM-6000R (USA version), set the program key on the microphone to serve as a “**T-CALL**” key. To change the configuration of this switch, use menu list [**14 MIC.PGM**].

Using the Memory

The FTM-6000R/E incorporates a large number of memory channels that can register the operating frequency, communication mode, and other operational information.

- 999 Memory Channels
- 1 Home Channel
- 50 pairs PMS Memory Channels

The operating frequency and other operational information can be registered to each regular memory channel, home channel, or PMS memory channel:

- Operating frequency
- Frequency Step
- Transmitter output
- Memory tag
- Repeater Shift
- Tone information
- DCS information
- Memory channel skip information

NOTE

Make sure to keep a separate record of the information registered to the memory channels.

Writing to memory

1. Set the frequency to write to memory.
2. Press and hold the [V/M MW] key.
 - “**M**” icon and a memory number will appear (blinking) on the display.
 - The lowest number that is not already stored in memory is selected. To select another channel, rotate the **DIAL** knob to select the memory channel number to be written.
 - Press the **DIAL** knob to fast-forward in 10 channel steps.

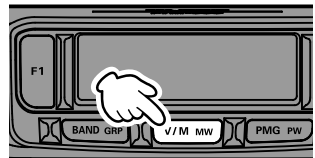

If the channel is already occupied by previously stored data, the “channel number” will light up on the display.

3. Press and hold the [V/M MW] key to save the entry and exit to normal operation.

If you attempt to register a frequency to a memory channel that already contains frequency data, “OVWRT?” will appear on the screen. Press the [V/M MW] key to overwrite the memory channel.

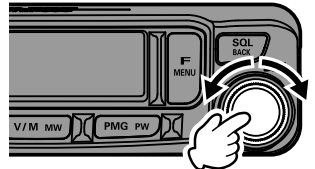

● Split Memory

Two different frequencies, one for receive and another for transmit, can be registered to a memory channel.



For additional details on the Split Memory, refer to the Advanced Manual which may be downloaded from the Yaesu website.

Recall memory

1. Press the [V/M MW] key.
 - The last used memory channel is recalled.
 - “**M**” icon and a memory number will appear on the display.

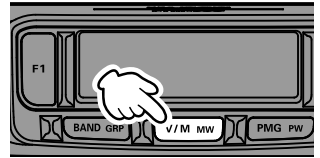

2. Rotate the **DIAL** knob to select the memory channel to recall.
3. Press the [V/M MW] key again to return to VFO mode.

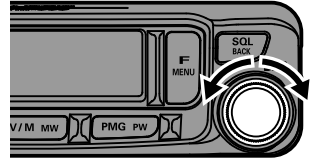

● Recall a memory by directly inputting the channel number using the numeric keys on the microphone

Press the numeric keys “0” to “9” in the memory mode to enter the memory channel.

(**Example**) When recalling memory channel “123”.

Press the [1] key.



Press the [2] key.



Press the [3] key.

(**Example**) When recalling memory channel “16”.

Press the [1] key.



Press the [6] key.



Press and hold any numeric key.

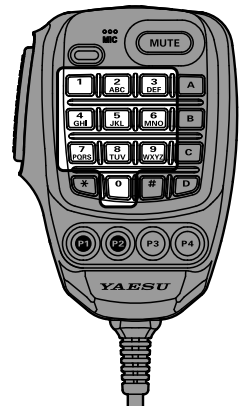





Press the **PTT** switch while entering a number to cancel the entry.

Recall only memories in the same frequency band (Band) using the memory auto grouping (MAG) function

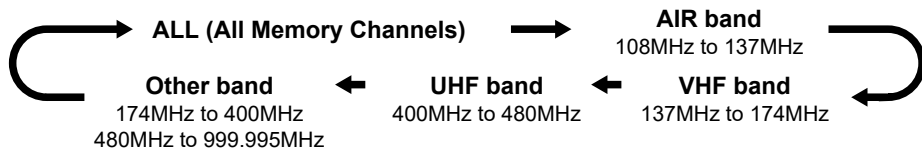
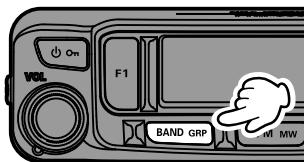
With the memory auto grouping (MAG) function, only memory channels in the same frequency band (Band) can be called.

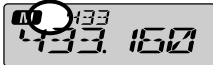
In the memory mode, each time the [BAND GRP] key is pressed, only memory channels of the specified frequency band are automatically recalled as a group, as shown below:

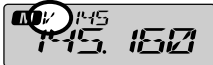
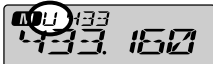

Group Name	Selectable Memory Channels
ALL No icon display 	All memory channels.
AIR "A" icon blink 	AIR band (108MHz to 137MHz) memory channels only.
VHF "V" icon blink 	VHF band (137MHz to 174MHz) memory channels only.
UHF "U" icon blink 	UHF band (400MHz to 480MHz) memory channels only.
Other "O" icon blink 	Other bands (174MHz to 400MHz & 480MHz to 999.995MHz) memory channels only.

PMG (Primary Memory Group)

If an often-contacted group of friends frequency is registered in a PMG (Primary Memory Group), that frequency can be recalled immediately by pressing the [**PMG PW**] key.

Register the frequency with PMG

1. Tune to the frequency or the memory channel to be registered in PMG.
2. Press and hold the [**PMG PW**] key to register the current channel to PMG.
 - To register another channel, repeat steps 1 and 2.



Up to 5 frequency channels can be registered to PMG.

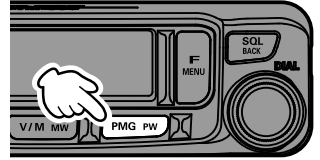

Recall the frequency registered in PMG

1. Press the [**PMG PW**] key.
2. Rotate the **DIAL** knob to select the frequency to recall. The “1 PM” to “5 PM” is shown while recalling the channel registered in **PMG**.
3. Press the [**PMG PW**] key. The display will return to the screen before starting PMG.

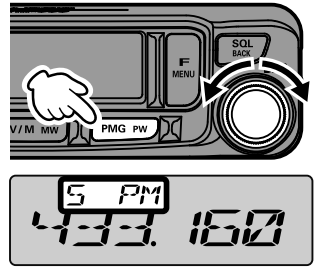

Deleting memory from PMG

To delete a channel from PMG, select the channel in PMG then press and hold the [**PMG PW**] key to cancel the registration.

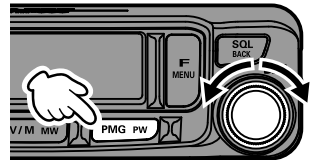

Disable the PMG function

1. Press the [**PMG PW**] key. The display will return to the screen before starting PMG.

To Append an Alpha-numeric “Tag” to a Memory

Memory name tags, such as a call sign may be assigned to the memory channels and home channels. Input a memory tag using up to 6 characters. Alphabetic characters, Numbers and Symbols may be entered to the memory name tag.

1. Recall the memory channel or HOME channel to assign the name.

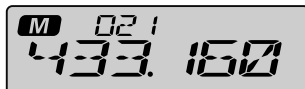

2. Press and hold the [V/M MW] key.

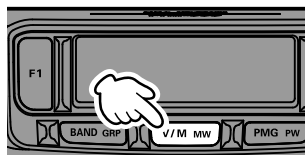

3. Rotate the **DIAL** knob to select “NAME”, and then press the **DIAL** knob.

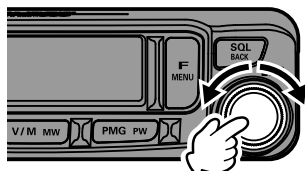

4. Rotate the **DIAL** knob to select the first character in the name to store.

5. Press the **DIAL** knob momentarily to move on to the next character. Letters, numbers, and symbols are available for storage.

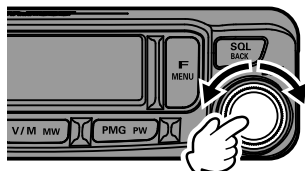

6. Again, rotate the **DIAL** knob to select the desired letter, number, or symbol, then press the **DIAL** knob momentarily to move on to the next character spaces.

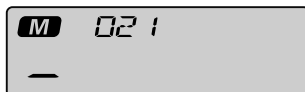

7. Repeat the above step to program the remaining letters, numbers, or symbols of the desired label. A total of six characters may be used in the creation of a label.

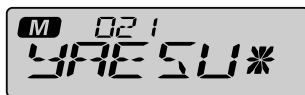

i The cursor position for character input moves to the left when the [BAND GRP] key is pressed, and it moves to the right when the [PMG PW] key.

8. When you have completed the creation of the label, press and hold the [V/M MW] key to save the label and exit to memory channel screen.
9. Each time the **DIAL** knob is pressed and held, the name tag display and the frequency display will switch.

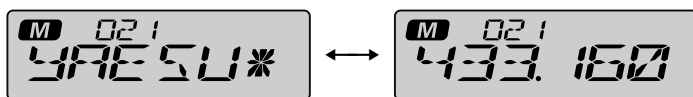

Clearing Memories

1. Select the memory channel from which the data is to be cleared, then press and hold the [V/M MW] key.
2. Rotate the **DIAL** knob to select [DELETE], then press the **DIAL** knob.
3. Press and hold the [V/M MW] key.
Confirmation screen "OK?" is displayed.
4. Press and hold the [V/M MW] key to clear the memory channel.

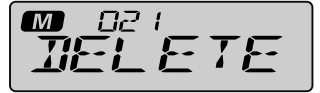
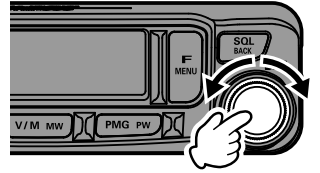
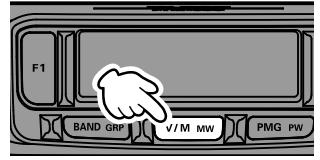

Data on memory channel 001, and the home channel may not be cleared.

Copying Memories

1. Select the memory channel from which the data is to be copied, then press and hold the [V/M MW] key.
"COPY" is displayed.
2. Press the **DIAL** knob.
3. Rotate the **DIAL** knob to select the copy destination channel.
4. Press and hold the [V/M MW] key to copy the memory channel.

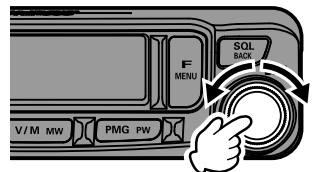
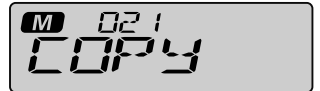
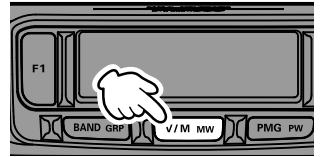

Recalling the Home Channel

● Recall with [F1] key

In the factory default setting, “HOME” (calls the home channel) is registered to the [F1] key.

1. Press the [F1] key.
“HM” and the home channel frequency appear on the LCD.
2. Press the [F1] key again, to return to the previous frequency.

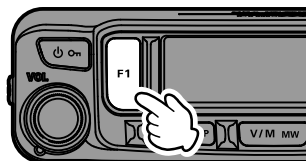

● Recall with Function list

With the factory default setting, “HOME” (calls the home channel) is registered to the Function list.

1. Press the [F MENU] key.
2. Rotate the **DIAL** knob to select [F-12 HOME], and then press the **DIAL** knob.
“HM” and the home channel frequency appear on the LCD.
3. Press the [V/M MW] key, to return to the previous frequency.

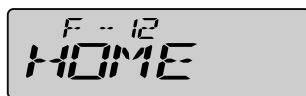
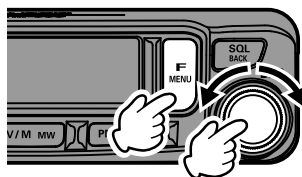

● Recall with Menu list

1. Press and hold the [F MENU] key.
2. Rotate the **DIAL** knob to select [12 HOME], and then press the **DIAL** knob.
“HM” and the home channel frequency appear on the LCD.

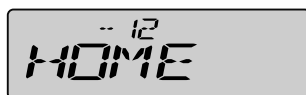
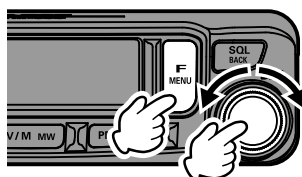

i If “12 HOME” is displayed as “- - - - -”, it is registered in the “Function list”, and it can be recalled by the “Recall with Function List” operation above.

3. Press the [V/M MW] key, to return to the previous frequency.

● Recall with Microphone

With the factory default setting, "HOME" (calls the home channel) is registered to the [P2] key of the Microphone.

1. Press the [P2]* key on the microphone.
 - * This is the factory setting. This function can also be assigned to the [P1] - [P4] key (see page 12).
2. Press the [P2] key again, to return to the previous frequency.

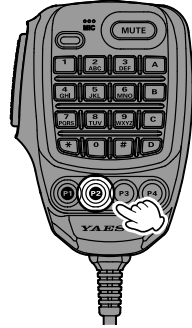

While the home channel is recalled, press and hold the [SQL BACK] key to transfer the home channel frequency to the VFO.

Changing the Home Channel Frequency

1. Set the frequency and the operating mode to store as the home channel.
2. Press and hold the [V/M MW] key.
3. Rotate the **DIAL** knob to the left to select "HM". "HM" is listed before memory channel "001".
4. Press and hold the [V/M MW] key to overwrite and display the changed home channel.

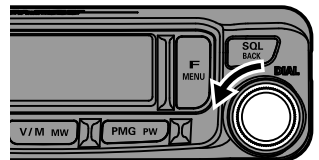
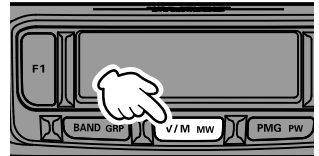

● Change with the [F1] key or the microphone key

When "HOME" is registered to the [F1] key and any microphone [P1], [P2], [P3] or [P4] key ([F1] and [P2] keys are the default settings), the setting can be changed by pressing and holding the registered key.

1. Set the frequency and the operating mode you want to store as a home channel.
2. Press and hold the [F1] or [P2] key to overwrite and display the changed home channel.

Scanning Function

The **FTM-6000R/E** supports the following scanning functions:

- VFO Scan
- Memory Channel Scan
- PMG (Primary Memory Group) Scan
- Programmable Memory Scan (PMS)

VFO Scan / Memory Scan / PMG Scan

To find frequencies where there are signals in VFO mode, memory mode or PMG mode:

1. Press the **[V/M MW]** key to switch to VFO mode or Memory mode.
 2. Press and hold the microphone **[UP]** or **[DWN]** switch to start scanning.
 - When the VFO scan is active, “VFO.SCN” appears on the display.
 - When the Memory scan is active, “MEM.SCN” appears on the display.
 - When the PMG scan is active, “PMG.SCN” appears on the display.
 - If the **DIAL** knob is rotated while scanning is in progress, the scanning will continue up or down in frequency according to the direction of the **DIAL** Knob rotation.
 - When a signal is received until the signal fades out. Two seconds after the signal fades out, scanning resumes.
3. Press the **PTT*** switch or **[UP]** or **[DWN]** on the microphone to cancel the scanning.

*The transceiver will not transmit in this case.

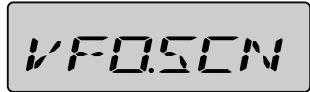
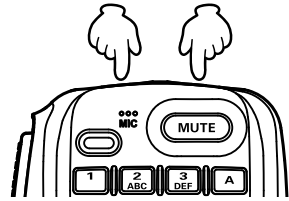
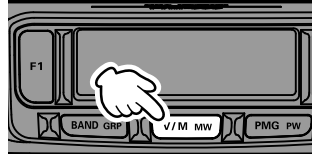

Display during VFO scanning

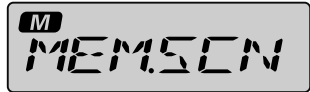

Display during Memory scanning

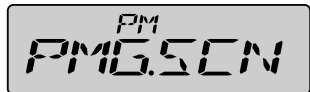

Display during PMG scanning



- If the scan has paused on a signal, rotating the **DIAL** knob will cause scanning to resume instantly.
- If the transceiver is turned OFF while scanning, when the transceiver is turned ON, scanning will resume.

Programmable Memory scan (PMS)

This function scans only the range of frequencies between the lower and upper limits registered in a pair of PMS Programmable Memory channels. 50 sets of PMS memory channels (L01/U01 to L50/U50) are available.



For additional details on the Programmable Memory Scan (PMS), refer to the Advanced Manual which may be downloaded from the Yaesu website.

Setting the Receive Operation When Scanning Stops

1. Press and hold the **[F MENU]** key.
2. Rotate the **DIAL** knob to select **[23 SCN.TYP]**, then press the **DIAL** knob.

“**SCN.RSM**” is displayed.

3. Press the **DIAL** knob again.
4. Rotate the **DIAL** knob to select the hold time after the scan is paused:

- **BUSY**

The signal is received until the signal fades out. Two seconds after the signal fades out, scanning resumes.

- **HOLD**

Scanning stops and tuning remains on the current receive frequency (Scanning does not resume).

- **1 sec / 3 sec / 5 sec**

The signal is received for a specified period of time, and then scanning resumes.

5. Press the **DIAL** knob to complete the setting.

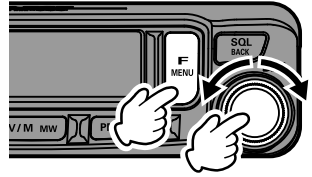

The above settings are common for all scanning operations.

Skip Memory Channels

Each memory channel can be set to be skipped during memory scan.

1. Select the memory channel number not to be scanned.
2. Press and hold the **[V/M MW]** key.
3. Rotate the **DIAL** knob to the right to select **[SCAN]**, then press the **DIAL** knob.
4. Rotate the **DIAL** knob to select **[SCAN N]**.
5. Press and hold the **[V/M MW]** key to complete the setting.

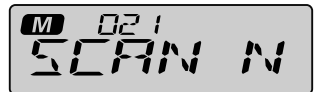
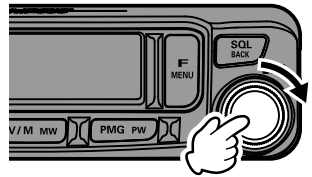
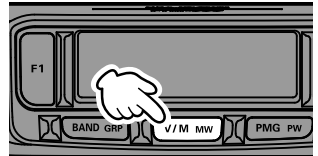

To re-institute a channel into the scanning loop, select “SCAN” in step 4 above (the “Skipped” channel will still be accessible via manual channel selection methods using the **DIAL** knob in the memory mode, whether or not it is locked out of the scanning loop).

Convenience Features

Bluetooth® Operation (Requires optional BU-4)

The **FTM-6000R/E** can be equipped with the **Bluetooth®** function by installing the optional Bluetooth® unit “**BU-4**”. Remote operation is possible using the optional Bluetooth® headset (**SSM-BT10**) or a commercially available Bluetooth® headset.



The operation of all commercially available **Bluetooth®** headsets cannot be guaranteed.

Installing the Bluetooth® unit “BU-4”



- Avoid touching the electronic components with your hands as the semiconductors may be damaged by static electricity.
- Note that labor charges to install optional items by our customer service support staff shall be separately chargeable.

1. Turn the transceiver **OFF**, then unplug the control cable from the front panel.
2. Remove the four screws from the front panel.
3. Carefully lift the back case of the front panel.

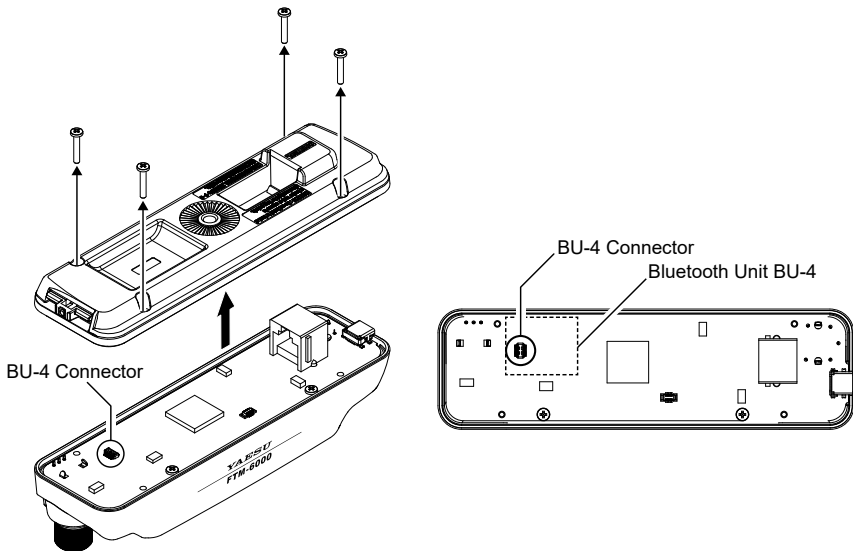

4. Refer to the figure to install the BU-4.



Check the direction of the connector and plug the BU-4 in all the way to the back.

5. Carefully attach the back cover and secure it with the four screws.



Do not tighten the four screws with excessive force.

Pairing the Bluetooth® Headset

When using the Bluetooth® Headset for the first time, the Bluetooth® Headset and the **FTM-6000R/E** must be paired.

This step is only necessary when first connecting the headset.

1. To start the Bluetooth® headset in pairing mode.

SSM-BT10: Press and hold the Multi-Function Button, until the **SSM-BT10** LED blinks red/blue alternately.

Press and hold the Multi-Function Button to turn ON.

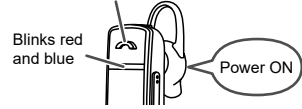

2. Press and hold the **[F MENU]** key.
3. Rotate the **DIAL** knob to select **[35 BLT]**, then press the **DIAL** knob.
The **"BLT.OFF"** is displayed.
4. Press the **DIAL** knob again.

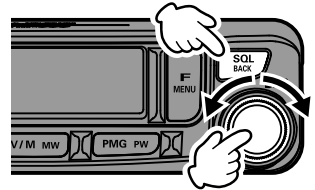
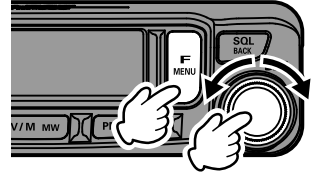

5. Rotate the **DIAL** knob to select **[BLT.ON]**, then press the **[SQL BACK]** key.
The **"⌘"** icon blinks on the **FTM-6000R/E** screen.

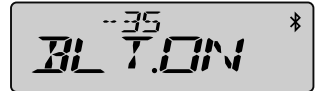

6. Rotate the **DIAL** knob to select **[BLT.LST]**, then press the **DIAL** knob.
The **"SEARCH"** is displayed.

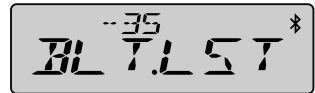

7. Press the **DIAL** knob again.
The model name of the Bluetooth® device found is displayed.



8. When the headset to be connected is displayed, press the **[SQL BACK]** to stop searching.

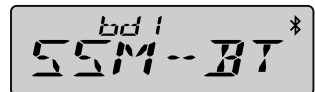

9. Rotate the **DIAL** knob to select the Bluetooth® headset to be connected, then press the **DIAL** knob.
The LED of **SSM-BT10** blinks blue. The pairing is completed.
10. Press the **PTT** switch to return to the normal operation.

While connected to a Bluetooth® headset, the **"⌘"** icon lights up on the **FTM-6000R/E** screen, and the received audio and operation beep will be heard from the Bluetooth® headset.

● Disable the Bluetooth® function

To cancel the Bluetooth® operation, just repeat the above procedures, selecting **"BLT.OFF"** in step 5 above.

● **Subsequent Bluetooth® headset connection when the power is turned ON**

- When the power is turned **OFF** while the Bluetooth® headset is connected, the next time the power is turned **ON**, the same Bluetooth® headset is searched for and automatically connected when found.
- If the Bluetooth® headset cannot be found, the “✳” icon blinks on the screen. If the power of the same Bluetooth® headset is turned **ON** in this state, it will connect automatically. If not, turn the **FTM-6000R/E** and Bluetooth® headset **OFF** and then **ON** again.
- To connect to other Bluetooth® headsets, refer to “Connect with another Bluetooth® headset” (see below).

Transmit operation by pressing the button on the Bluetooth® headset

Pressing the “Call button”* on the Bluetooth® headset once will engage the **FTM-6000R/E** in transmit, and then a call can be made using the Bluetooth® headset.

Press the “Call button”* again to return the **FTM-6000R/E** to receive.

*The button name may differ depending on your Bluetooth® headset.

SSM-BT10: When the **Multi-Function** Key is pressed, a beep will sound and the **FTM-6000R/E** will continuously transmit.

Press the **Multi-Function** Key again, a beep will sound and the **FTM-6000R/E** will return to receive mode.

Press briefly to transmit



Connect with another Bluetooth® headset

1. Press and hold the [**F MENU**] key.
2. Rotate the **DIAL** knob to select [**35 BLT**], then press the **DIAL** knob.

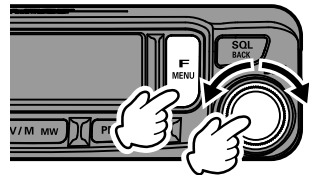

3. Rotate the **DIAL** knob to select [**BLT.LST**] then press the **DIAL** knob.
4. If the “✳” icon lights up on the **FTM-6000R/E** screen, press the **DIAL** knob.

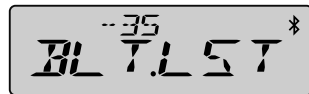

The “✳” icon flashes on the **FTM-6000R/E** screen and the Bluetooth® headset disconnects.

5. Rotate the **DIAL** knob to select “**SEARCH**”.
6. Press the **DIAL** knob.

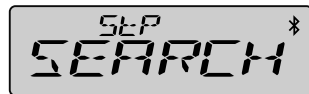

The model name of the Bluetooth® device found is displayed.

7. When the headset to be connected is displayed, press the [**SQL BACK**] to stop searching.
8. Rotate the **DIAL** knob to select the Bluetooth® headset to be connected, then press the **DIAL** knob.

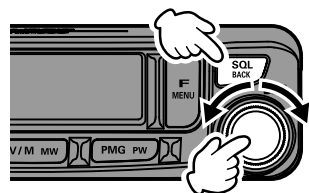

Connecting to a registered (paired) Bluetooth® headset

1. Press and hold the **[F MENU]** key.
2. Rotate the **DIAL** knob to select **[35 BLT]**, then press the **DIAL** knob.

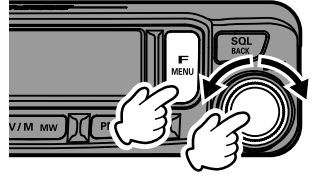

3. Rotate the **DIAL** knob to select **[BLT.LST]** then press the **DIAL** knob.

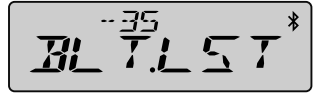

4. Rotate the **DIAL** knob to select the Bluetooth® headset to be connected, then press the **DIAL** knob.

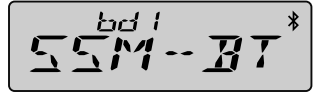

Remove a registered (paired) Bluetooth® device from the list

1. Press and hold the **[F MENU]** key.
2. Rotate the **DIAL** knob to select **[35 BLT]**, then press the **DIAL** knob.

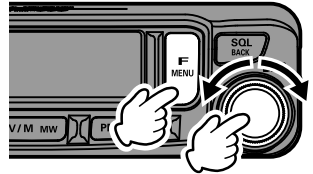

3. Rotate the **DIAL** knob to select **[BLT.LST]** then press the **DIAL** knob.

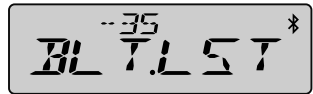

4. Rotate the **DIAL** knob to select the Bluetooth® headset to be deleted.

5. If the "⌘" icon lights up on the **FTM-6000R/E** screen, press the **DIAL** knob.

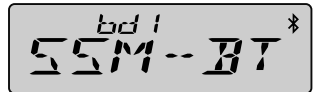

The "⌘" icon flashes on the **FTM-6000R/E** screen and the Bluetooth® headset disconnects.

6. Press and hold the **DIAL** knob.
The Bluetooth® headset is deleted from the device list.

Bluetooth® battery save function

Turning on the Bluetooth® Battery Saver feature extends the battery life of the standby Bluetooth® headset.

1. Press and hold the **[F MENU]** key.
2. Rotate the **DIAL** knob to select **[35 BLT]**, then press the **DIAL** knob.
3. Rotate the **DIAL** knob to select **[BLT.SAV]**, then press the **DIAL** knob.
4. Rotate the **DIAL** knob to select **"ON"**.
5. Press the **DIAL** knob to complete the setting.

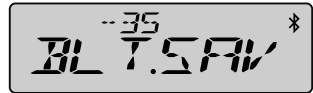
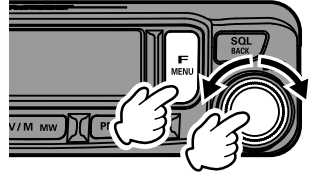

● Disable the battery save function

To cancel Bluetooth® Battery Saver feature, just repeat the above procedures, selecting **"OFF"** in step 4 above.

Bluetooth® received audio output

When a Bluetooth® headset is connected, the received audio can automatically be output from the headset only, or from both the headset and the transceiver speaker.

1. Press and hold the **[F MENU]** key.
2. Rotate the **DIAL** knob to select **[35 BLT]**, then press the **DIAL** knob.
3. Rotate the **DIAL** knob to select **[BLT.AF]**, then press the **DIAL** knob.
4. Rotate the **DIAL** knob to select **[AUTO]** or **[FIX]**.

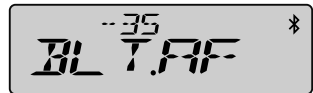
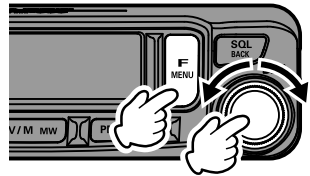

AUTO: The received audio comes from only the Bluetooth® headset.

FIX: The received audio comes from both the Bluetooth® headset and the speaker of this transceiver.

5. Press the **DIAL** knob to complete the setting.

Changing the Frequency Step

The **DIAL** knob rotation frequency step may be changed. Normally, use the factory default setting of “**AUTO**”.

1. Press and hold the [**F MENU**] key.
2. Rotate the **DIAL** knob to select [**27 STEP**], then press the **DIAL** knob.
3. Rotate the **DIAL** knob to set the frequency step.
4. Press the **DIAL** knob to complete the setting.

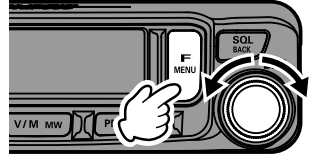

- The default setting, of the frequency step is set to “**AUTO**”, which automatically provides a suitable frequency step according to the frequency band.
- The frequency steps that can be selected depend on the frequency band.

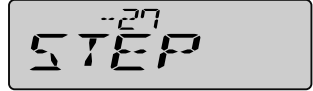

Changing the Transmit Power Level

The transmit power level can also be changed using the function list.

1. Press the [**F MENU**] key.
2. Rotate the **DIAL** knob to select [**F-30 TX PWR**], then press the **DIAL** knob.

With the factory default setting, it is registered in the “Function list” that is displayed when you press the [**F MENU**] key.

3. Rotate the **DIAL** knob to select the transmit power output.

“**LOW**”→“**MID**”→“**HIGH**”

4. Press the **DIAL** knob to complete the setting.

Display of PO meter during transmission

HIGH ██████████	MID ██████████	LOW ██████████
50 W	25 W	5 W

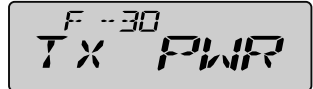
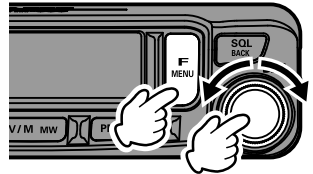

*: The factory setting is “**HIGH**”.



- When the “**TX PWR**” function is assigned to the [P2], [P2], [P3] or [P4] key of the microphone, the assigned key may be used as the Transmit Power Level select key.
 1. Press and hold the [**F MENU**] key.
 2. Rotate the **DIAL** knob to select [**14 MIC.PGM**], then press the **DIAL** knob.
 3. Rotate the **DIAL** knob to select a key to assign a function [PGM.P1] / [PGM.P2] / [PGM.P3] / [PGM.P4] then press the **DIAL** knob.
 5. Rotate the **DIAL** knob to select a “**TX PWR**” then press the **DIAL** knob.
- The transmit power output can be set individually for each frequency band (144MHz or 430MHz bands) and memory channel.



For additional details on the following Functions, refer to the Advanced Manual which may be downloaded from the Yaesu website.

Tone squelch feature

The tone squelch opens the speaker audio only when a signal containing the specified CTCSS tone is received. By matching the tone frequency with the partner station in advance, a quiet standby is possible.

Digital Code squelch (DCS) feature

DCS (Digital Coded Squelch) function allows audio to be heard only when signals containing the matching DCS code are received.

PAGER (EPCS) feature

This feature allows calling specified stations only, by using a pager code that combines two CTCSS tones. Even when the person who is called is not near the transceiver, the information is displayed on the LCD to indicate that a call was received. When the call is received, the bell sounds.

Automatic Range Transponder System (ARTS)

The ARTS feature uses DCS signaling to inform both parties when you and another ARTS equipped station are within communications range.

Using Menu List

The Menu list Mode permits configuring the various functions to accommodate individual operating needs and preferences.

Menu List Operation

1. Press and hold the [**F MENU**] key.
The Menu list will be displayed.
2. Rotate the **DIAL** knob to select the desired item in the Menu list, then press the **DIAL** knob.

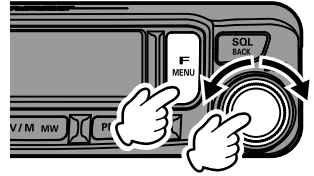

- Items displayed by “-----” are assigned to the “function list” that is displayed by pressing [**F MENU**] key.
- With the factory default setting, “F-12 HOME”, “F-19 RPT.REV”, “F-20 RPT.SET”, and “F-30 TX PWR” are assigned to the function list.
- To select an item in the “Function list”, press and hold the [**SQL BACK**] key, the assignment to the “Function list” will be canceled and the function can display it in the menu list mode.

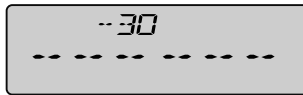

Assigned to a function list

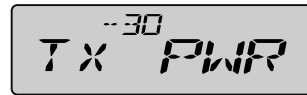

Display in Menu list Mode

3. Rotate the **DIAL** knob to change the setting value.
4. Press the **DIAL** knob to return to normal operation.

Tables of Menu list Operations

Note: For details, refer to the Advanced Manual (download from the Yaesu website).

Number / Menu Item	Description	Selectable options (Options in bold are the default settings)
01: APO	Enables/Disables the Automatic Power Off feature.	OFF / 0.5H 1.0H / 1.5H / 2.0H to 12.0H
02: AR MOD	Select the ARTS Beep mode.	OFF / IN RNG / OUTRNG
03: AR INT	Select the Polling Interval during ARTS operation.	30 SEC / 1 MIN
04: BCLO	Enables/Disables the Busy Channel Lock-Out feature.	OFF / ON
05: BEEP	Set the beep level.	OFF / LOW / HIGH
06: BELL	Select the CTCSS/DCS/EPCS Bell Ring-er repetitions.	OFF / 1TIME / 3TIMES / 5TIMES / 8TIMES / CONTI
07: CLK.TYP	Shift the CPU clock frequency.	TYP A / TYP B
08: DIMMER	Set the front panel display illumination level.	OFF / MID / MAX
09: DTMF	Enable/Disable the DTMF Autodialer feature.	MANUAL / AUTO
10: DT TX	Load DTMF Autodialer Memories.	---
11: DT MEM	Register a DTMF code.	CH1 to CH9
12: HOME*	Recall the home channel.	Depends on the transceiver version.
13: MIC.GIN	Adjust the microphone gain level.	MIN / LOW / NORMAL / HIGH / MAX
14: MIC.PGM		
PGM.P1	Program the function assigned to the Microphone [P1] key.	ARTS / SCN ON / HOME / RPT.SFT / RPT.REV / TX PWR / SQL OFF / T-CALL / DW / WX
PGM.P2	Program the function assigned to the Microphone [P2] key.	Default values: P1: SQL OFF
PGM.P3	Program the function assigned to the Microphone [P3] key.	P2: HOME
PGM.P4	Program the function assigned to the Microphone [P4] key.	P3: SCN ON P4: WX (USA version) T-CALL (European/Asian versions)
15: PAGER		
PAG.CDR	Set the Receive Pager Code for the Enhanced CTCSS Paging & Code Squelch function.	01 to 50 Default value: R05.47
PAG.CDT	Set the Transmit Pager Code for the Enhanced CTCSS Paging & Code Squelch function.	01 to 50 Default value: T05.47
16: PKT.SPD	DATA communication baud rate settings.	1200BP / 9600BP
17: RX MODE	Select the receive mode.	AUTO / FM / AM
18: BND.SEL	Set the frequency bands that can be selected.	AIR: ON / OFF VHF: ON / OFF UHF: ON / OFF OTH: ON / OFF

Number / Menu Item	Description	Selectable options (Options in bold are the default settings)
19: RPT.REV*	Reverses the transmit and receive frequencies while working through a repeater.	---
20: RPT.SET*	Set the Repeater Shift direction.	SIMP / -SFT / +SFT
21: RPT.OTR		
RPT.ARS	Activate/Deactivate the Automatic Repeater Shift feature.	OFF / ON
RPT.FRQ	Set the magnitude of the Repeater Shift.	0.00 - 99.95 (MHz) (Depends on the transceiver version.)
22: SCN.ON	Engages the Scan operation.	---
23: SCN.TYP		
SCN.RSM	Select the Scan Resume mode.	BUSY / HOLD / 1 SEC / 3 SEC / 5 SEC
DW RVT	Enable/Disable the "Dual Watch Revert" feature.	OFF / ON
24: SQL.TYP	Selects the Tone Encoder and/or Decoder mode.	OFF / TON.ENC / TON.SQL / REV.TON / DCS / PR FRQ / PAGER / DCS.ENC* / TONE.DCS* / DCS.TSQ* *Displayed when "26 SQL.EXP" is "ON".
25: SQL.COD	Set the CTCSS Tone Frequency or the DCS code.	CTCSS: 67.0 to 254.1 (Hz) (100.0Hz) DCS: 104 standard DCS codes (023)
26: SQL.EXP	Enable/Disable the split CTCSS/DCS coding.	OFF / ON
27: STEP	Set the frequency synthesizer steps.	AUTO / 5 / 6.25 / (8.33) / 10 / 12.5 / 15 / 20 / 25 / 50 / 100 (kHz) (8.33 kHz: only for Air band)
28: xx.xF (C)	Indicates the current temperature inside the transceiver.	---
29: TOT	Set the Time-Out Timer.	OFF* / 1 MIN / 2 MIN / 3 MIN / 5 MIN* / 10 MIN / 15 MIN / 20 MIN / 30 MIN (Depends on the transceiver version.)
30: TX PWR*	Set the transmit power level.	LOW / MID / HIGH
31: VER.DSP	Display the transceiver software version.	Mxx.xx (MAIN) Pxx.xx (PANEL)
32: xx.xV	Indicates the DC Supply Voltage.	---
33: WIDTH	Set the FM transmit modulation level and receiver bandwidth.	WIDE /NARROW
34: WX ALT	Weather alert operation setting.	OFF /ON
35: BLT		
BLT.OFF	Set the Bluetooth function.	OFF /ON
BLT.LST	Bluetooth device list.	---
BLT.SAV	Set the Bluetooth save function.	OFF /ON
BLT.AF	Set the Bluetooth received audio output.	AUTO /FIX

* In the factory default, the grayed settings are assigned to the "Function list" that is displayed when the [F MENU] key is pressed.

Restoring to Defaults (All Reset)

Caution

When the All Reset function is performed, all data registered in the memory will be deleted. Be sure to keep a separate record of the information registered to the memory channels.

To restore all transceiver settings and memory content to the factory defaults.



The all reset can be canceled by pressing the PTT switch during the operation.

1. Turn the transceiver **OFF**.
2. Simultaneously, press and hold the **[BAND GRP]**, **[V/M MW]** and the **[PMG PW]** keys, and turn the transceiver **ON**.
“**ALL.RST**” appears on the LCD.

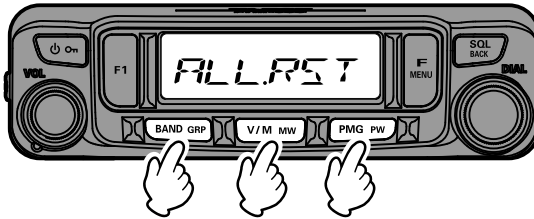

3. Press the **DIAL** knob.
“**ALL.RST**” appears on the LCD.

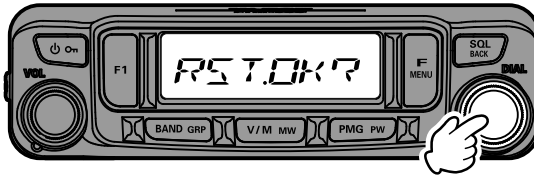

4. Press the **DIAL** knob again.
The display indicates “**RST.ING**”, then changes to “**RST.CMP**” when all resets are complete.

● General

Frequency Range	: TX 144 - 148MHz or 144 - 146MHz 430 - 450MHz or 430 - 440MHz (Depends on the transceiver version)
	: RX 108 - 137MHz (AIR Band) 137 - 174MHz (144MHz HAM / VHF Band) 174 - 400MHz (GEN) 400 - 480MHz (430MHz HAM / UHF Band) 480 - 999.99MHz (GEN) (USA Cellular Blocked)
Channel Steps	: 5 / 6.25 / 8.33 / 10 / 12.5 / 15 / 20 / 25 / 50 / 100kHz (8.33kHz: only for Air band)
Mode of Emission	: F2D, F3E
Frequency Stability	: ± 2.5 ppm (-4°F to +140°F [-20°C to +60°C])
Antenna Impedance	: 50 Ω
Supply Voltage	: Nominal 13.8V DC, negative ground
Current Consumption (approx.)	: 0.5A (Receive) 10A (50W TX, 144MHz) 10A (50W TX, 430MHz)
Operating Temperature Range	: -4°F to +140°F (-20°C to +60°C)
Case Size (W x H x D)	: Radio unit 5.47" x 1.66" x 5.2" (139 x 42 x 132mm) (w/o Fan) Controller 5.51" x 1.6" x 1.38" (140 x 40.5 x 35mm) (w/o Knob)
Weight (approx.)	: 2.43lbs (1.1kg) (with Radio Unit, Controller, Control Cable)

● Transmitter

RF Power Output	: 50W / 25W / 5W
Modulation Type	: F2D, F3E: Variable Reactance Modulation
Maximum Deviation	: ± 5 kHz
Spurious Emission	: At least 60dB below
Microphone Impedance	: 2k Ω
DATA Jack Impedance	: 10k Ω

● Receiver

Circuit Type	: Double-Conversion Super heterodyne
Intermediate Frequency	: 1st: 58.05MHz, 2nd: 450kHz
Sensitivity	: 0.8 μ V TYP for 10dB SN (108 - 137MHz, @AM) 0.2 μ V for 12dB SINAD (137 - 140MHz, @FM) 0.2 μ V for 12dB SINAD (140 - 150MHz, @FM) 0.25 μ V for 12dB SINAD (150 - 174MHz, @FM) 0.3 μ V TYP for 12dB SINAD (174 - 222MHz, @FM) 0.25 μ V TYP for 12dB SINAD (222 - 300MHz, @FM) 0.8 μ V TYP for 10dB SINAD (300 - 336MHz, @AM) 0.25 μ V for 12dB SINAD (336 - 420MHz, @FM) 0.2 μ V for 12dB SINAD (420 - 470MHz, @FM) 0.2 μ V for 12dB SINAD (470 - 540MHz, @FM) 0.8 μ V for 12dB SINAD (540 - 800MHz, @FM) 0.4 μ V TYP for 12dB SINAD (800 - 900MHz, @FM) 0.8 μ V TYP for 12dB SINAD (900 - 999.99MHz, @FM) Cellular Blocked (USA only)
Selectivity (-6dB/-60dB)	: NFM, AM 12kHz / 30kHz
AF Output	: 3W (8 Ω , THD10%, 13.8V) Internal Speaker 3W (8 Ω , THD10%, 13.8V) External Speaker
AF Output Impedance	: 8 Ω
Strength of secondary radio waves	: 4nW and below

● Bluetooth (Optional BU-4)

Version	: Version 4.2
Class	: Class 2
Output Power	: 2dBm

Specifications are subject to change without notice, and are guaranteed within the 144/430MHz amateur bands only.

The Bluetooth® wordmark and logo are registered trademarks owned by Bluetooth SIG, Inc. and are used under license by Yaesu Musen Co., Ltd.

About internal spurious signals

The internal oscillator frequency relationship below may cause some effect on the receiver mixer and IF circuits. However, this is not a malfunction (refer to the calculation formulas below: n is any integer).

- Reception frequency = 16 MHz x n times
- Reception frequency = 12 MHz x n times
- Reception frequency = 57.6 MHz x n times
- Reception frequency = 44 MHz x n times

YAESU LIMITED WARRANTY

Limited Warranty is valid only in the country/region where this product was originally purchased.

On-line Warranty Registration:

Thank you for buying YAESU products! We are confident your new radio will serve your needs for many years! Please register your product at www.yaesu.com - Owner's Corner

Warranty Terms:

Subject to the Limitations of the Warranty and the Warranty Procedures described below, YAESU MUSEN hereby warrants this product to be free of defects in materials and workmanship in normal use during the "Warranty Period." (the "Limited Warranty").

Limitations of Warranty:

- A. YAESU MUSEN is not liable for any express warranties except the Limited Warranty described above.
- B. The Limited Warranty is extended only to the original end-use purchaser or the person receiving this product as a gift, and shall not be extended to any other person or transferee.
- C. Unless a different warranty period is stated with this YAESU product, the Warranty Period is three years from the date of retail purchase by the original end-use purchaser.
- D. The Limited Warranty is valid only in the country/region where this product was originally purchased.
- E. During the Warranty Period, YAESU MUSEN will, at its sole option, repair or replace (using new or refurbished replacement parts) any defective parts within a reasonable period of time and free of charge.
- F. The Limited Warranty does not cover shipping cost (including transportation and insurance) from you to us, or any import fees, duties or taxes.
- G. The Limited Warranty does not cover any impairment caused by tampering, misuse, failure to follow instructions supplied with the product, unauthorized modifications, or damage to this product for any reasons, such as: accident; excess moisture; lightning; power surges; connection to improper voltage supply; damage caused by inadequate packing or shipping procedures; loss of, damage to or corruption of stored data; product modification to enable operation in another country/purpose other than the country/purpose for which it was designed, manufactured, approved and/or authorized; or the repair of products damaged by these modifications.
- H. The Limited Warranty applies only to the product as it existed at the time of the original purchase, by the original retail purchaser, and shall not preclude YAESU MUSEN from later making any changes in design, adding to, or otherwise improving subsequent versions of this product, or impose upon YAESU MUSEN any obligation to modify or alter this product to conform to such changes, or improvements.
- I. YAESU MUSEN assumes no responsibility for any consequential damages caused by, or arising out of, any such defect in materials or workmanship.
- J. TO THE FULLEST EXTENT PERMITTED BY LAW, YAESU MUSEN SHALL NOT BE RESPONSIBLE FOR ANY IMPLIED WARRANTY WITH RESPECT TO THIS PRODUCT.
- K. If the original retail purchaser timely complies with the Warranty Procedures described below, and YAESU MUSEN elects to send the purchaser a replacement product rather than repair the "original product", then the Limited Warranty shall apply to the replacement product only for the remainder of the original product Warranty Period.
- L. Warranty statutes vary from state to state, or country to country, so some of the above limitations may not apply to your location.

Warranty Procedures:

1. To find the Authorized YAESU Service Center in your country/region, visit www.yaesu.com. Contact the YAESU Service Center for specific return and shipping instructions, or contact an authorized YAESU dealer/distributor from whom the product was originally purchased.
2. Include proof of original purchase from an authorized YAESU dealer/distributor, and ship the product, freight prepaid, to the address provided by the YAESU Service Center in your country/region.
3. Upon receipt of this product, returned in accordance with the procedures described above, by the YAESU Authorized Service Center, all reasonable efforts will be expended by YAESU MUSEN to cause this product to conform to its original specifications. YAESU MUSEN will return the repaired product (or a replacement product) free of charge to the original purchaser. The decision to repair or replace this product is the sole discretion of YAESU MUSEN.

Other conditions:

YAESU MUSEN'S MAXIMUM LIABILITY SHALL NOT EXCEED THE ACTUAL PURCHASE PRICE PAID FOR THE PRODUCT. IN NO EVENT SHALL YAESU MUSEN BE LIABLE FOR LOSS OF, DAMAGE TO OR CORRUPTION OF STORED DATA, OR FOR SPECIAL, INCIDENTAL, CONSEQUENTIAL, OR INDIRECT DAMAGES, HOW EVER CAUSED; INCLUDING WITHOUT LIMITATION TO THE REPLACEMENT OF EQUIPMENT AND PROPERTY, AND ANY COSTS OF RECOVERING, PROGRAMMING OR REPRODUCING ANY PROGRAM OR DATA STORED IN OR USED WITH THE YAESU PRODUCT.

Some Countries in Europe and some States of the USA do not allow the exclusion or limitation of incidental or consequential damages, or a limitation on how long an implied warranty lasts, so the above limitation or exclusions may not apply. This warranty provides specific rights, there may be other rights available which may vary between countries in Europe or from state to state within the USA.

This Limited Warranty is void if the label bearing the serial number has been removed or defaced.

Changes or modifications to this device that are not expressly approved by YAESU MUSEN could void the user's authorization to operate this device.

This device complies with part 15 of the FCC Rules. Operation is subject to the following two conditions: (1) This device may not cause harmful interference, and (2) this device must accept any interference including received, interference that may cause undesired operation.

The scanning receiver in this equipment is incapable of tuning, or readily being altered, by the User to operate within the frequency bands allocated to the Domestic public Cellular Telecommunications Service in Part 22.

The YAESU MUSEN is not responsible for any changes or modifications not expressly approved by the party responsible for compliance. Such modifications could void the user's authority to operate the equipment.

This device complies with ISED's applicable license-exempt RSS standard(s). Operation is subject to the following two conditions: (1) this device may not cause interference, and (2) this device must accept any interference, including interference that may cause undesired operation of the device.

Le présent appareil est conforme aux CNR d'Industrie Canada applicables aux appareils radio exempts de licence. L'exploitation est autorisée aux deux conditions suivantes : (1) l'appareil ne doit pas produire de brouillage, et (2) l'utilisateur de l'appareil doit accepter tout brouillage radioélectrique subi, même si le brouillage est susceptible d'en compromettre le fonctionnement.

DECLARATION BY MANUFACTURER

The Scanner receiver is not a digital scanner and is incapable of being converted or modified to a digital scanner receiver by any user.

WARNING: MODIFICATION OF THIS DEVICE TO RECEIVE CELLULAR RADIOTELEPHONE SERVICE SIGNALS IS PROHIBITED UNDER FCC RULES AND FEDERAL LAW.

CAN ICES-3 (B) / NMB-3 (B)

This equipment has been tested and found to comply with the limits for a Class B digital device, pursuant to part 15 of the FCC Rules. These limits are designed to provide reasonable protection against harmful interference in a residential installation. This equipment generates, uses, and can radiate radio frequency energy; and, if not installed and used in accordance with the instructions, may cause harmful interference to radio communications. However, there is no guarantee that interference will not occur in a particular installation.

If this equipment does cause harmful interference to radio or television reception, which can be determined by turning the equipment off and on, the user is encouraged to try to correct the interference by one or more of the following measures:

- Reorient or relocate the receiving antenna.
- Increase the separation between the equipment and receiver.
- Connect the equipment into an outlet on a circuit different from that to which the receiver is connected.
- Consult the dealer or an experienced radio/TV technician for help.

This equipment complies with FCC/IC radiation exposure limits and meets the FCC radio frequency (RF) Exposure Guidelines and RSS-102 of the IC radio frequency (RF) Exposure rules. This equipment has very low levels of RF energy that is deemed to comply without testing of specific absorption rate (SAR).

This transmitter must not be co-located or operated in conjunction with any other antenna or transmitter.

YAESU

Declaration of Conformity

Type of Equipment:	144/430MHz Digital/Analog Transceiver
Brand Name:	YAESU
Model Number:	FTM-6000R
Manufacturer:	YAESU MUSEN CO., LTD.
Address of Manufacturer:	Tennozu Parkside Building, 2-5-8 Higashi-Shinagawa, Shinagawa-ku, Tokyo 140-0002 Japan

This device complies with part 15 of the FCC Rules. Operation is subject to the following two conditions; (1) this device may not cause harmful interference, and (2) this device must accept any interference received, including interference that may cause undesired operation.

The technical documentation as required by the Conformity Assessment procedures is kept at the following address:

Company: Yaesu U.S.A.

Address: 6125 Phyllis Drive, Cypress, CA 90630, U.S.A.

Telephone: (714) 827-7600

EU Declaration of Conformity

We, Yaesu Musen Co. Ltd of Tokyo, Japan, hereby declare that this radio equipment FTM-6000E is in full compliance with EU Radio Equipment Directive 2014/53/EU. The full text of the Declaration of Conformity for this product is available to view at <http://www.yaesu.com/jp/red>

ATTENTION – Condition of use

This transceiver operates on frequencies that are regulated. Use of the Transmitter in the EU countries shown in the accompanying table is not permitted without authorization. Users should consult their local spectrum management authority for licensing conditions applicable to this equipment.

					
AT	BE	BG	CY	CZ	DE
DK	ES	EE	FI	FR	UK
EL	HR	HU	IE	IT	LT
LU	LV	MT	NL	PL	PT
RO	SK	SI	SE	CH	IS
LI	NO	–	–	–	–

Disposal of Electronic and Electrical Equipment

Products with the symbol (crossed-out wheeled bin) cannot be disposed as household waste.

Electronic and Electrical Equipment should be recycled at a facility capable of handling these items and their waste by-products.

Please contact a local equipment supplier representative or service center for information about the waste collection system in your country.



YAESU

The radio

Copyright 2021
YAESU MUSEN CO., LTD.
All rights reserved.

No portion of this manual may be
reproduced without the permission of
YAESU MUSEN CO., LTD.

YAESU MUSEN CO., LTD.

Tennozu Parkside Building
2-5-8 Higashi-Shinagawa, Shinagawa-ku, Tokyo 140-0002 Japan

YAESU USA

6125 Phyllis Drive, Cypress, CA 90630, U.S.A.

YAESU UK

Unit 12, Sun Valley Business Park, Winnall Close
Winchester, Hampshire, SO23 0LB, U.K.

2110G-BS
Printed in Japan

