

PL-680

**PLL SYNTHESIZED RECEIVER
FM STEREO / MW / LW / SW-SSB / AIR BAND**

OPERATION MANUAL



FEATURES

- FM-stereo/MW/LW/SW/SW SSB/AIR band with high sensitivity, selectivity and user-friendliness
- FM band coverage: 76 – 108 MHz
- Shortwave Single Side Band (SSB) with upper sideband (USB) and lower sideband (LSB)
- Equipped with Synchronous Detector and Dual Conversion technology for MW band; this greatly enhances the receiver's sensitivity, selectivity, image rejection, and interference from adjacent stations
- FM/SW external antenna jack sensitivity selector: DX/Normal/Local antenna gain
- Multiple tuning methods
- Store up to 2000 stations (manually, semi-automatic and fully automatic)
- Equipped with a high-sensitivity acoustic speaker with treble/bass tone control switch (FM-stereo via earphone)
- Auto Alarm-Off Timer: when the alarm goes off, the preset radio station will play for 1-90 minutes
- Sleep timer (1-120 minutes) to turn off the radio automatically
- User-friendly interface
- Built-in charging function
- Powered by 4 x AA (R6) size batteries, DC 6V
- Luxury carrying case
- Dimensions: 188 x 116 x 31 mm

TABLE OF CONTENTS

CONTROL LOCATIONS.....	2
LCD DISPLAY.....	4
HOW TO TURN ON/OFF THE RADIO.....	5
TUNING INTO STATIONS.....	6
● Manual Station Tuning	
● Auto Browse Station	
● Direct Keypad Entry	
WORKING WITH STATION MEMORIES.....	8
● Storing Stations Manually	
● Semi-Automatic Station Storage	
● ATS (Auto Tuning Storage)	
● Memory Tuning Manually	
● Auto Browse Memory	
● Direct Key in Memory Address	
● Delete Single Memory Manually	
● Semi-Auto Delete Memory	
● Delete ALL Memories within a Page	
LISTENING TO STORED STATIONS.....	12
SLEEP FUNCTION.....	13
TIME SETTING.....	13
ALARM SETTING.....	14
SETTING ALARM STATION	
SETTING THE ALARM TIME	
SNOOZE FUNCTION.....	15
INTELLIGENT LIGHT FUNCTION.....	15
TUNING STEP SETTINGS.....	16
FM ST. (FM STEREO).....	16
AM BW (BANDWIDTH).....	17
ANT. GAIN.....	17
tone CONTROL.....	17
KEY-LOCK FUNCTION.....	17
INTELLIGENT CHARGING FUNCTION.....	18
SINGLE SIDE BAND (SSB).....	18
SYNCHRONOUS DETECTOR.....	19
HOW TO IMPROVE FM / SW RECEPTION.....	19
SYSTEM SETTINGS.....	20
RESET PROCEDURE.....	21
IMPORTANT MATTERS FOR USING BATTERIES.....	21
TROUBLE SHOOTING.....	22
SPECIFICATIONS.....	23

CONTROL LOCATIONS

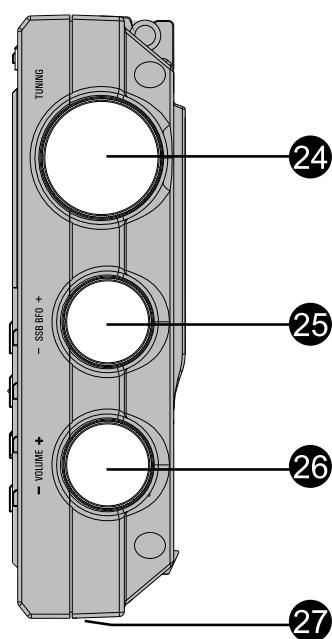
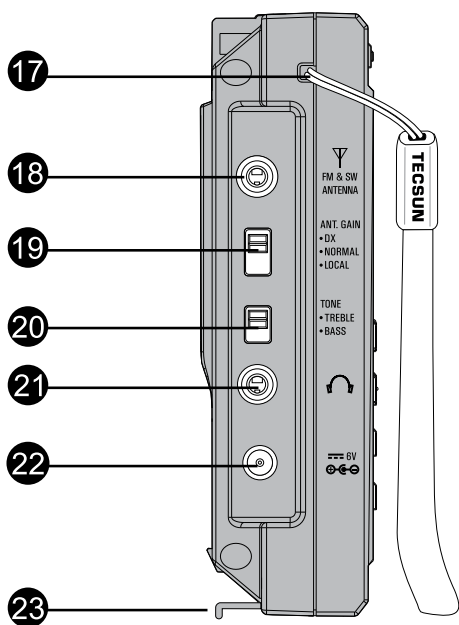
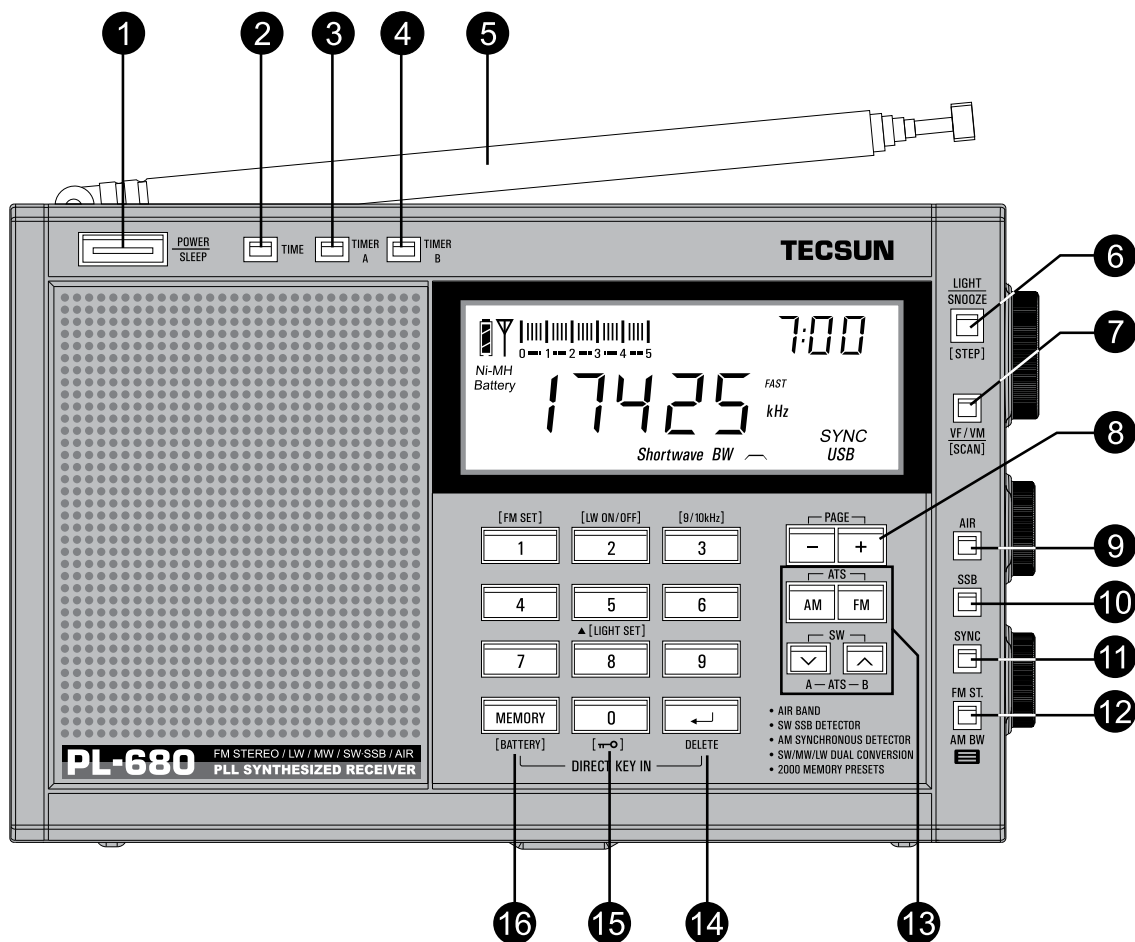





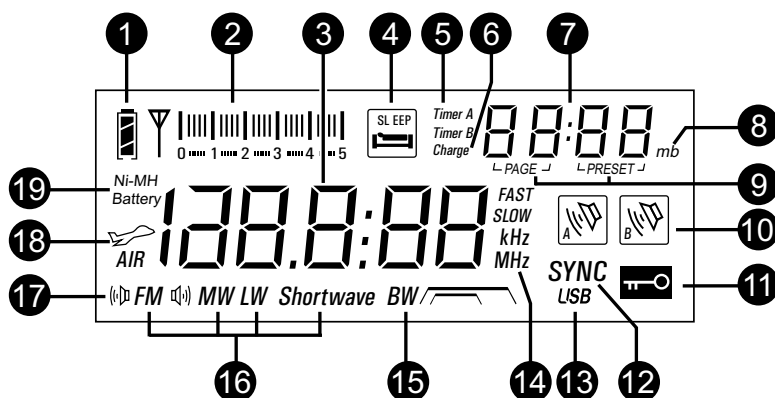

-
- ① Power / Sleep button
 - ② Time set button
 - ③ Timer A Alarm set button
 - ④ Timer B Alarm set button
 - ⑤ FM & SW Telescopic Antenna
 - ⑥ Light / Snooze / Step button
 - ⑦ VF / VM / SCAN
 - ⑧ -/+ PAGE buttons
 - ⑨ Air Band button
 - ⑩ Single Side Band (SSB) button
 - ⑪ Synchronous (SYNC) button
 - ⑫ FM. ST & AM BW select button
 - ⑬ FM / AM (MW, LW) / SW Band & ATS buttons
 - ⑭ Delete / Enter button
 - ⑮ Key lock button
 - ⑯ Memory / Battery button
 - ⑰ Hand Carry Strap
 - ⑱ FM / SW Antenna Jack
 - ⑲ ANT. Gain (DX / Normal / Local) switch
 - ⑳ Treble / Bass Tone Control
 - ㉑ Earphone Jack
 - ㉒ DC 6V Jack
 - ㉓ Metal Stand
 - ㉔ Tuning Knob
 - ㉕ SSB BFO knob
 - ㉖ Volume knob
 - ㉗ Reset button

Note: For the silk-printing in red or orange on radio with brackets, it means that you can only operate it when radio is off.

LCD DISPLAY



- ① Battery Consumption indicator
 - “” : Full
 - “” : Empty
- ② Signal Strength indicator
 - “” : Strong Signal
 - “” : Weak Signal
- ③ Digital Number Display:
 - With radio off: Time & System settings
 - With radio on: Frequency or Error display
- ④ Sleep timer indicator
- ⑤ Alarm Timer A or B – Timer indicator
- ⑥ Charging Indicator
- ⑦ Digital Number Display:
 - With radio off: preset alarm time and charging time
 - With radio on: time, page & memory address, SW meter band displays.
- ⑧ SW meter band indicator
- ⑨ PAGE: Memory Page number
PRESET: Memory Address number
- ⑩ Alarm Timer A or B - On/Off indicator
- ⑪ Key-Lock indicator
- ⑫ Synchronous band detection
- ⑬ Single Side Band (SSB) indicator
 - USB: Upper Side Band
 - LSB: Lower Side Band
- ⑭ Tuning Speed:
 - Slow: Slow Tuning
 - Fast: Fast Tuning
 - KHz: frequency unit for MW, LW & SW
 - MHz: frequency unit for FM
- ⑮ AM Band width indicator
 -  : AM Wide band
 -  : AM Narrow band
- ⑯ FM, MW, LW and SW Band indicator
- ⑰ FM Stereo indicator
- ⑱ Air Band indicator
- ⑲ Ni-MH Rechargeable Battery indicator

HOW TO TURN ON/OFF THE RADIO

1. Open the battery compartment located on the back of the unit; install 4 x UM3 AA size batteries observing the battery polarity diagram on the back of the radio. Close the battery door.

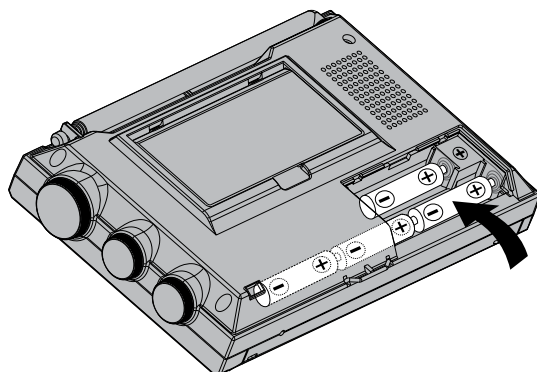

Connect the unit to the regulated power supply.

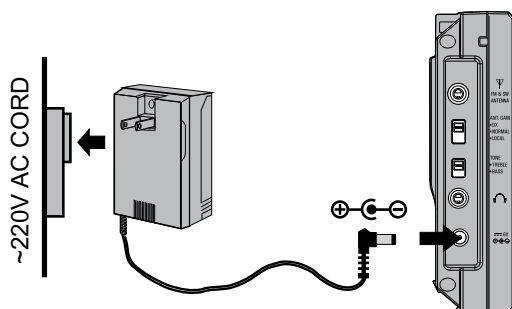

2. Press the [POWER] button to turn on the radio.

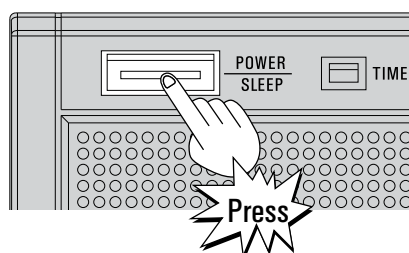

Note:

If the radio is unable to power on, please check if the batteries are installed correctly, battery capacity is sufficient, and the key lock function is turned off; to deactivate the key lock function press & hold the [] button.

Long press the power button to adjust the sleep timer setting.

TUNING INTO STATIONS

Press the [POWER] button to turn on your radio, then select your desired band by pressing [FM], [AM], SW [∨] / [∧], or [AIR] button. In case of receiving FM/AIR/SW broadcasting, fully extend the telescopic antenna for a better reception. When receiving MW and LW broadcasting, please rotate the radio or change its location to achieve optimum reception. You can rotate the [VOLUME] knob to adjust to an appropriate volume.

Now, you can turn into your favorite stations with any of the below tuning methods:

METHOD 1: MANUAL STATION TUNING

Press the [VF/VM] button to enter the frequency mode (VF), the frequency display flashes twice. Now rotate the [TUNING] knob to select your desired station.

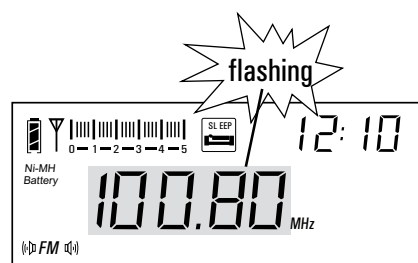

Frequency mode

METHOD 2: AUTO BROWSE STATION

1. Press the [VF/VM] button to enter the frequency mode (VF), the frequency display flashes twice.
2. Press & hold the [VF/VM] button to browse to the next available station, pre-listening the station for five seconds before continuing to browse.
3. To stop the auto browse function, simply rotate the [TUNING] knob or press on the [VF / VM] button again to confirm on your desired station.

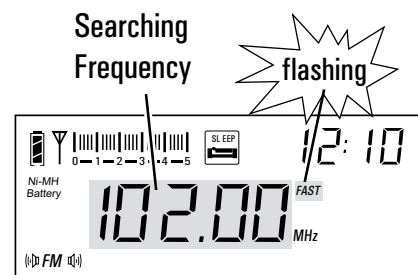

Auto browse station

Notes:

1. While operating the "Auto Browse Station" function, you can press the [MEMORY] button anytime to store the station into memory, and the radio will keep on auto browsing the next available station.
2. The "Auto Browse Station" function is not available for Air Band and SW SSB frequencies.

TUNE IN STATIONS

METHOD 3: DIRECT KEYPAD ENTRY

1. Press the [VF/VM] button to enter the frequency mode (VF), the frequency display flashes twice.
2. Press the numeric keys [0] - [9] to enter the station frequency directly.

Notes:

1. Ignore the decimal point for FM band when inputting the frequency numbers. For example, FM 89.3 MHz, just enter .
2. If the entered frequency is not within the covered range, an error symbol "Err" is displayed.

WORKING WITH STATION MEMORIES

The PL-680 has 2000 station memories, which are organized over 12 memory pages.

1. Memory PAGE 0, noted as [P0], consists of 800 memories, 100 assigned for FM/MW/LW, 200 for SW & SSB and 100 for AIR BAND.
2. Memory PAGE 1~12, noted as P1, P2, etc., each page consists of 100 memories, in total 2000 memories.

BAND MEMORY	Memory for each Band (800)		Memory among all Band (1200)	
	PAGE P0	ATS	PAGE 01-12	ATS
FM	100	✓	Each Memory Page can store 100 Memories.	ATS is available for all Memory Pages (except Air Band)
MW	100	✓		
LW	100	✓		
SW	200	✓		
SSB	200	✓		
AIR	100	✗		

METHOD 1: STORING STATIONS MANUALLY

1. Press the [FM], [AM] (for MW and LW) or [SW] button for band selection, then tune into your desired station.
2. Press the [MEMORY] button; the next available memory position flashes.
3. Rotate the [TUNING] knob to specify your preferred memory position.
4. Press the [MEMORY] button again to confirm. You can also wait for 3 seconds to auto store the station into memory.

NOTE: To store the station in a different memory page, press the [- PAGE +] button.

METHOD 2: SEMI-AUTOMATIC STATION STORAGE

While operating the “Auto Browse Station” (refer to page 06) function, you can simply press the [MEMORY] button to store the station into memory to avoid unwanted stations.

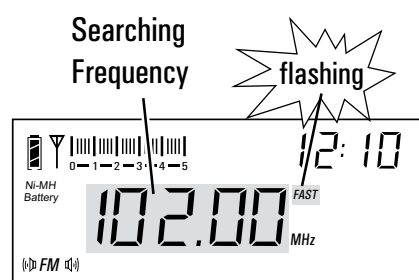

Auto browse station

WORKING WITH STATION MEMORIES

METHOD 3: ATS (AUTO TUNING STORAGE)

FM ATS:

1. Fully extend the telescopic antenna and press the [FM] button to select FM band.
2. To automatically store all available stations, press & hold the [FM] button; "PRESET" will flash in the top right corner of the display while the frequency starts running. The frequency stops running once the ATS operation has completed. Rotate the [TUNING] knob to browse all stored FM stations.

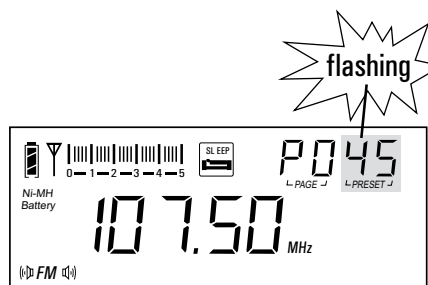

MW/LW ATS:

1. Press the [AM] button to select MW/LW band.
2. Press & hold the [AM] button to perform ATS on the MW or LW band.

SW ATS:

Fully extend the telescopic antenna and press the SW [∨] or [∧] button to select SW band. There are two modes for SW ATS tuning:

- Mode A: Press & hold the [∨] button to ATS the stations within all meter bands
- Mode B: Press & hold the [∧] button to ATS the stations within present meter band only.

Notes:

1. While performing ATS in FM, MW/LW or SW (mode A) bands, previously stored stations are replaced by the newly found stations.
2. While performing ATS in SW (mode B) band, previously stored stations are not replaced. Instead, all newly found stations are stored in blank memory positions.
3. If the surrounding area has too much interference or many mirror/blank stations are stored during ATS, try to contract the telescopic antenna (for FM and SW) or rotate the radio (for MW and LW). Also try to push the [ANT. GAIN] switch into "NORMAL" or "LOCAL" position. Then perform ATS again.

WORKING WITH STATION MEMORIES

DELETE MEMORY

Press the [VF/VM] button to enter the memory mode; the memory address shows in the upper right corner of the display.

METHOD 1: DELETE SINGLE MEMORY

Rotate the [TUNING] knob to select the memory that you want to delete, press & hold the [DELETE] button with “*dEL*” flashing; then press the [DELETE] button to remove the unwanted memory address.

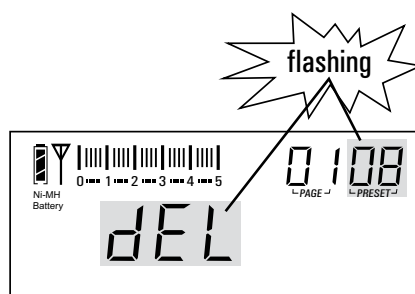

Delete Single Memory

Note:

If “*dEL*” is flashing more than 3 seconds without confirmation, it will exit the delete function automatically.

METHOD 2: SEMI-AUTO DELETE MEMORY

Press and hold the [VF / VM] to auto browse stations, then you can press the [DELETE] button anytime to direct delete the unwanted station; the radio will keep on auto browsing the next available station until you press any other button to stop this function.

METHOD 3: DELETE ALL MEMORIES WITHIN A PAGE

Press & hold the [DELETE] button for 3 seconds and notice both “Memory address” & “*dEL*” flashing, then follow with “Memory Page” and “*dEL*” flashing on the upper right corner of display. Press the [DELETE] button again to delete all memory within the selected page.

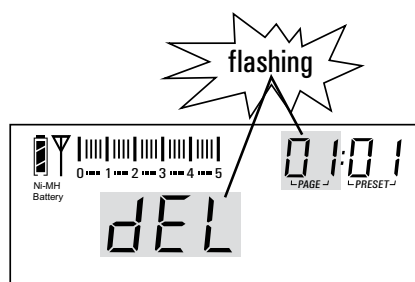

Delete ALL Memory

Note:

If the [DELETE] button has not been pressed within 3 seconds to confirm, it will exit the delete function automatically.

WORKING WITH STATION MEMORIES

AUTO SORTING MEMORY

To sort all stored stations automatically, turn the device off, then press and hold the [] button for 2 seconds until the memory page number in the upper right corner starts running.

This function is able to:

1. Remove duplicate stations. Especially useful after storing stations manually, as you might store a station more than once.
2. Sorting the sequence of stored stations.
 - In page P0, select your desired band to find all stored stations in sequence of frequency (from low to high).
 - In page 01-12, all stored stations are sorted in band sequence (FM, SW, MW, Air band, LW) and placed in sequence of frequency (from low to high).

LISTENING TO STORED STATIONS

Select the band of your desired station, then press the [VF/VM] button to enter the memory mode; the memory address shows in the upper right corner of the display. Press the [- PAGE +] button to select the memory page in which to search for stored stations using any of the below memory tuning methods.

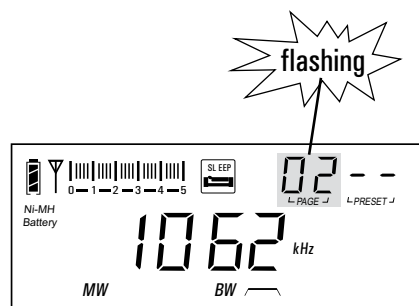

Changing memory pages

METHOD 1: MANUAL MEMORY TUNING

Rotate the [TUNING] knob to tune around the stored stations.

METHOD 2: AUTO BROWSE MEMORY

Press & hold the [VF/VM] button to browse to the next stored station, pre-listening each station for five seconds before continuing to browse. While browsing, "PRESET" flashes on the display. To stop browsing, rotate the [TUNING] knob or press the [VF/VM] button again.

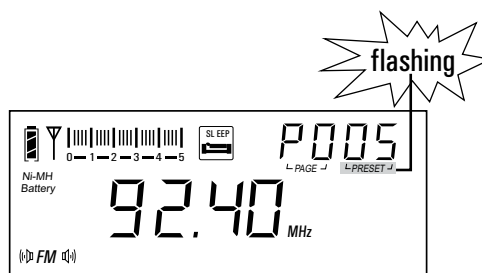

Auto browse memory

METHOD 3: DIRECT KEY IN MEMORY ADDRESS

Press the numeric keys [0] - [9] to enter the memory address directly, and then press the \leftarrow button to confirm.

Note: If the display shows " - - - - " symbol after entering the number, it means the entered memory page/address does not exist.

SLEEP FUNCTION

1. In POWER OFF mode, press & hold the [POWER] button until the sleep timer symbol "  " flashes on the display.

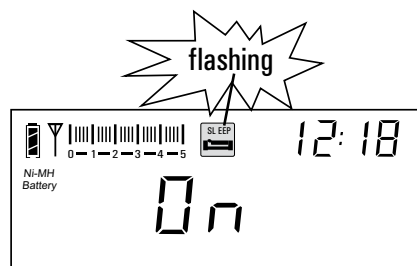

2. Rotate the [TUNING] knob immediately to select a sleep timer from 1 - 120 minutes or select "  " for POWER ON mode (the radio will be turned on after 1 second).

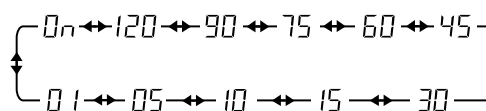

Time selection for sleep timer

Note: The default setting of the sleep timer is "ON".

TIME SETTING

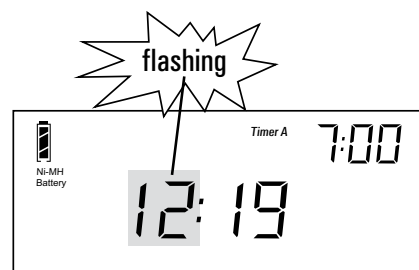

1. Press & hold the [TIME] button until the hours indicator starts flashing. Rotate the [TUNING] knob to adjust the hours, or directly input the time by pressing the [0 – 9] numeric keys.
2. While the hours indicator is flashing, press the [TIME] button again to select the minutes indicator. Rotate the [TUNING] knob to adjust the minutes, or directly enter it by pressing the [0 – 9] numeric keys.
3. Short press the [TIME] button to confirm, or wait for 3 seconds to automatically confirm the time setting.



Time setting

ALARM SETTING (By Radio only)

SETTING THE ALARM STATION:

1. Turn on the radio, then tune into your favorite station and adjust your desired alarm volume level.
2. Press the [MEMORY] button and then immediately press the [TIMER A] or [TIMER B] button and notice “” or “” flashing on the display to confirm the preset alarm station.

SETTING THE ALARM TIME

1. Press & hold the [TIMER A] button until the hours indicator starts flashing in the upper right corner of the display. Rotate the [TUNING] knob to adjust the hours, or directly enter the alarm time by pressing the [0 – 9] numeric keys.
2. While the hours indicator flashes, press the [TIMER A] button to select the minutes indicator. Rotate the [TUNING] knob to adjust the minutes, or directly enter it by pressing the [0 – 9] numeric keys.
3. Press the [TIMER A] button again, then rotate the [TUNING] knob to select from 1 - 90 minutes to set the "Alarm Off Timer". This is the time duration after which the radio will be turned off automatically.
4. Press the [ALARM] button to confirm the setting or wait for 3 seconds, the unit will automatically confirm the alarm setting.

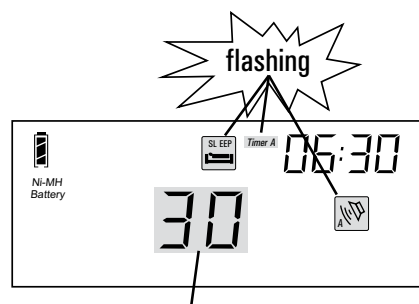



Setting timer for alarm off

Note: Follow the above instructions using the [TIMER B] button to set a second alarm.

SNOOZE FUNCTION

When the alarm goes off, press the [LIGHT/SNOOZE] button to temporarily turn off the alarm. The alarm will go off again after 5 minutes.

Notes:

1. To turn off/on the alarm, press the [TIMER A] or [TIMER B] button; the alarm is activated when the "  " or "  " symbol is displayed.
2. When the alarm goes off, press the [POWER] button once to deactivate the "Alarm Off Timer"; press it twice to turn off the radio.
3. If the preset alarm is activated when you are listening to the radio, it will automatically switch to that station when the alarm goes off.

INTELLIGENT LIGHT FUNCTION

This device has an intelligent backlight function, meaning the backlight is lit for about 5 seconds after operating any keys or knobs.

TURN ON/OFF THE BACKLIGHT:

Press the [LIGHT/SNOOZE] button to illuminate the LCD for 30 seconds. Press it again to turn off the backlight.

Notes:

1. When the unit is powered by batteries, to reduce power consumption, please try to avoid setting the backlight to 30-seconds illumination.
2. When the unit is turned off, the 30-seconds illumination function is turned off as well.

TUNING STEP SETTINGS

There are three tuning step speed settings: slow, fast, and intelligent (slow & fast). In Frequency Mode (VF), press & hold the [STEP] button to select your preferred setting.

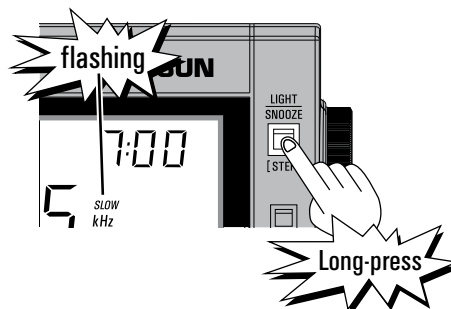

The intelligent tuning step notices when you rotate the [TUNING] knob in a slow or fast way. When rotating fast, the tuning steps will be larger.

NOTE: intelligent tuning step is not available for Air Band.

TUNING STEP BAND	SLOW TUNING STEPS Slowly rotate the [TUNING] knob	FAST TUNING STEPS Quickly rotate the [TUNING] knob
FM	0.01 MHz	0.1MHz
MW	1kHz	9kHz / 10kHz
LW	1kHz	9kHz
SW	1kHz	5kHz
AIR	1kHz	25kHz

FM ST. (FM STEREO)

- When listening to radio broadcastings through stereo earphones, press the [FM.ST] button to activate the stereo function; the " (◂◃) " symbol appears on the display. If the FM signal is too weak, it is advised to turn off the stereo function by pressing the [FM ST.] button again; the " (◂◃) " symbol disappears.
- When listening to FM stereo through a speaker, it is advised to turn off the stereo function to improve sound quality.
- The stereo function will not be activated and the " (◂◃) " symbol will not appear if the FM station is not in stereo broadcasting.

AM BW (BANDWIDTH)

Press the [AM BW] button to select your desired bandwidth for MW, LW, SW, and SSB.

Wide Band

It has better audio fidelity when receiving strong signals or local stations.

Narrow Band

It is suitable to receive weak and long distance stations as the narrow band is able to limit the interference from adjacent strong signals and reduce background noise.

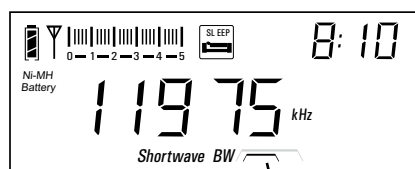

AM Bandwidth Indicator

ANT. GAIN

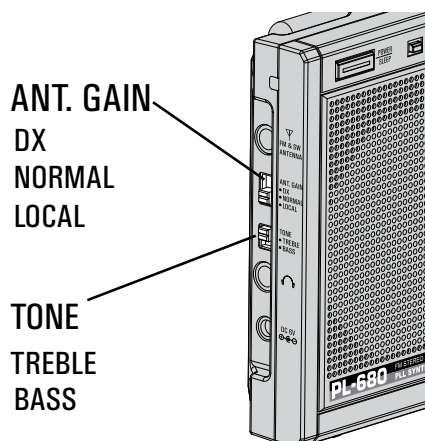

While listening to SW, push the [ANT.GAIN] switch to "DX" position for normal listening. For stations with a strong signal or strong electrical interference, push the [ANT.GAIN] switch to either "NORMAL" or "LOCAL" to achieve better sensitivity.



TONE CONTROL

Push the [TONE] switch upward for "TREBLE" listening, downward or "BASS" tone.

KEY LOCK FUNCTION

To activate the key lock function, press & hold the [] button; the "  " symbol appears on the display. Press & hold the [] button again to unlock.

INTELLIGENT CHARGING FUNCTION

In power off mode, install 4 x UM3 (AA size) rechargeable (Ni-MH) batteries to activate the built-in charging function. Connect the external adaptor to start charging the batteries. The symbol "  " will advance from down to up while charging. It stops when the batteries are fully charged.

When using non-rechargeable batteries, please turn off the charging function; press & hold the [BATTERY] button, the "  " symbol disappears from the display.

Notes:

1. Before using new Ni-MH rechargeable batteries for the first time, please charge them overnight. This will increase battery life.
2. Do not use batteries of different capacities at the same time.
3. Do not try to charge non-rechargeable batteries. This will damage both the batteries and the device.
4. Please do not use an external adaptor with a different voltage, this will damage the device.
5. When charging, if the external power adapter and the battery cover become hot, this is normal.

SINGLE SIDE BAND (SSB)

1. In Shortwave mode, press the [SSB] button repeatedly to select Upper Side Band (USB) or Lower Side Band (LSB).
 - "USB" showing on the display indicates USB selection.
 - "LSB" showing on the display indicates LSB selection.
 - "USB" and "LSB" disappearing means switching to SW.
2. Enter the SSB frequency directly by pressing the numeric keys [0 – 9].
3. Then fine tune the [SSB BFO] knob to achieve better sound fidelity.

SYNCHRONOUS DETECTOR

When receiving AM broadcasting, if there is interference from adjacent strong signals, you can activate the SYNC function to improve the reception.

1. Press the [SYNC] button to select between " SYNC_{USB} " or " SYNC_{LSB} " for optimum reception.
2. To deactivate the SYNC function, press the [SYNC] button until both " SYNC_{USB} " and " SYNC_{LSB} " symbols are no longer on the display.

Notes: If the "SYNC" symbol keeps flashing, this indicates that the radio signal is too weak or the frequency is deviant. It is recommended to deactivate synchronous detection as it is unable to function properly.

HOW TO IMPROVE FM / SW RECEPTION

Use the external wire antenna to plug into the [FM & SW ANTENNA] jack, then position the opposite end outside the window for better FM and SW reception.

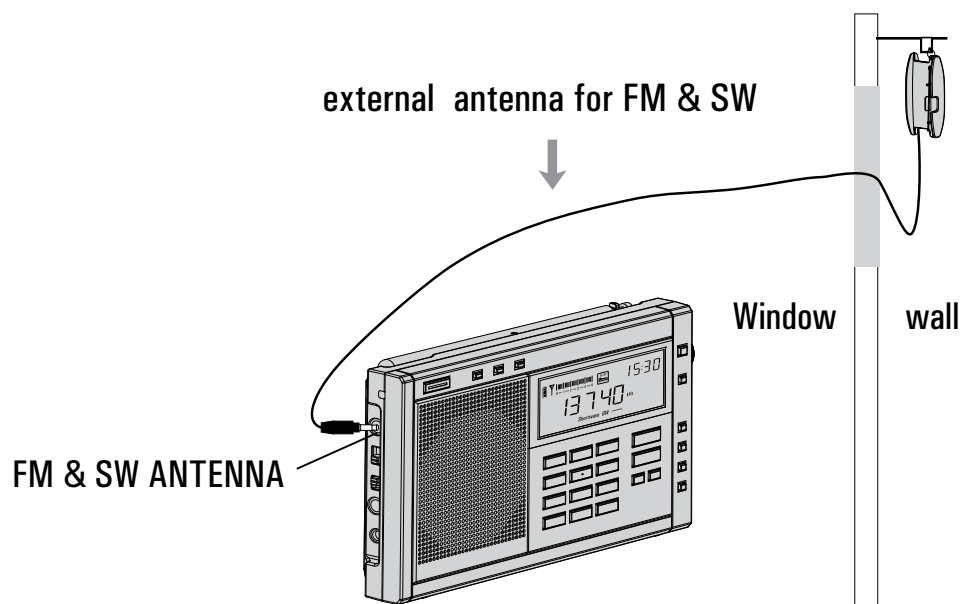

Caution: Do not place the external antenna outdoors during a thunderstorm!

SYSTEM SETTINGS (In Power Off Mode)

SETTING FM FREQUENCY RANGE:

Press & hold the [FM SET] button until 88-108MHz, 76-108MHz or 87-108MHz appears on the display. Press the [FM SET] button to select a suitable frequency range for FM.

TURN ON/OFF THE LW:

To turn ON/OFF LW, press & hold the [LW ON/OFF] button until "LW ON" or "LW OFF" appears on the display.

SETTING MW (AM) TUNING STEP:

To select your desired AM tuning steps, press & hold the [9/10kHz] button until "9kHz" or "10kHz" appears on the display.

TURN ON/OFF THE INTELLIGENT LIGHT FUNCTION

The Intelligent Light Function is activated by default, which will illuminate the backlight for 5 seconds after operating any button or knob. To deactivate, press & hold the [LIGHT SET] button until "OFF" appears on the display; repeat the operation to reactivate.

Note: After deactivating the Intelligent Light Function, the [LIGHT/SNOOZE] button can still be used to turn on/off the back light.

TURN ON/OFF THE CHARGING FUNCTION

Using Regular Batteries for power supply:

In radio off mode, press & hold the [BATTERY] button until "CHA OFF" is shown on the display. When the charging mode is deactivated, "Ni-MH Battery" does not appear below the battery consumption indicator.

Using Rechargeable Batteries for power supply:

In radio off mode, press & hold the [BATTERY] button until "CHA ON" is shown on the display. When the charging mode is activated, "Ni-MH Battery" appears below the battery consumption indicator.

Note: The default setting is for using rechargeable batteries. For a correct battery power indication when using regular batteries, deactivate the charging function.

RESET PROCEDURE

If not functioning properly, you can reset the device by sticking a pointed object (such as a straightened paper clip) into the reset hole and gently press the [RESET] button.

Note: Resetting the device will not delete any station memories.

IMPORTANT MATTERS FOR USING BATTERIES

1. When the device is not powered by batteries or the adaptor for a long time, the clock setting is lost, but the stored radio stations are saved.
2. When battery power is low, the "  " symbol starts flashing to alert you to charge the batteries or change to new ones. The device turns off automatically when all power is gone.
3. Do not mix new and used batteries, this may damage the radio and display an incorrect power capacity.
4. In order to avoid leakage, always remove the batteries when the unit will not be used for a long period of time.

TROUBLE SHOOTING

QUESTIONS	ANSWERS	SOLUTIONS
Cannot turn on the radio.	<ul style="list-style-type: none"> - Batteries have no power - Batteries are installed incorrectly. - Key lock function is activated. 	<ul style="list-style-type: none"> - Replace all batteries with new ones. - Take note of the correct polarity direction, then reinstall the batteries. - Press the [↔] button to deactivated it.
Radio turns off while listening.	<ul style="list-style-type: none"> - Batteries have no power - Sleep timer is activated. 	<ul style="list-style-type: none"> - Replace or charge all batteries. - Turn the radio on again.
During ATS, some stations cannot be stored. Some stored stations have noise.	<ul style="list-style-type: none"> - Frequency of stations is too weak. - There is interference near by your area. 	<ul style="list-style-type: none"> - Search the station manually. - Contract the antenna or move to other location and try again.
Only few FM stations can be received.	<ul style="list-style-type: none"> - FM frequency may have been set to 76 - 90MHz accidentally. 	<ul style="list-style-type: none"> - Turn off the radio, press & hold the [FM SET] button to select the accurate FM frequency range.
Poor AM reception in USA.	<ul style="list-style-type: none"> - USA uses 10kHz AM tuning steps, the device may still be set to 9kHz. 	<ul style="list-style-type: none"> - Turn off the radio press the [9/10kHz] button to select accurate tuning step.
The sound of SW SSB broadcasting is too low.	The default bandwidth is Narrow band.	Press the [AM BW] button to select the Wide band.

TROUBLE SHOOTING

QUESTIONS	ANSWERS	SOLUTIONS
When the alarm goes off, there is only noise in the broadcasting.	<p>-Did not set the proper radio station for the alarm.</p> <p>-Or there is no broadcasting at that frequency.</p>	<p>-Preset your alarm station properly</p> <p>-Make sure it is possible to receive radio broadcastings at your location.</p>
The charging time becomes shorter and shorter.	The rechargeable batteries are getting old.	Replace the old rechargeable batteries with new ones.
Radio malfunction.	There may be some form of interference, causing the microchip to not function properly.	Remove the batteries. Reinstall the batteries once the device's display has turned off completely. If the device is still not working, please press the reset button with a pointed object.

SPECIFICATIONS

1. Frequency Range:

FM: 76~108 / 87~108 MHz Step: 0.01MHz / 0.1 MHz

MW: 522~1620 / 520~1710 kHz

Tuning Step: 9K for North America or other countries/10K for South America

LW: 100~519 kHz Step: 1 kHz/ 9 kHz

SW: 1711~29999 kHz Step: 1 kHz/ 5 kHz

AIR: 118~137MHz Step: 1kHz / 25 kHz

2. Sensitivity

FM (S/N=30dB) Less than 3uV

MW (S/N=26dB) Less than 1mV/m

LW (S/N=26dB) Less than 5mV/m

SW (S/N=26dB) Less than 20uV

SSB(S/N=10dB) Less than 1uV

AIR (S/N=10dB) Less than 5uv

3. Selectivity

FM > 30 dB (± 200 kHz)

MW/LW > 40 dB (± 9 kHz)

SW > 40 dB (± 5 kHz)

4. S/N Ratio

FM Less than 60dB

MW/LW Less than 45dB

SW Less than 50dB

5. AM Frequency

SSB, AM 1st IF: 55.845MHz

2nd IF: 455 kHz

FM: 10.7MHz

6. FM Stereo crosstalk Less than 20 dB

7. Output Power

Speaker \geq 450 mW

Earphone \geq 10 mW

SPECIFICATIONS

8. Station Memory 2000M in total

- 800 memories for each band:
 - FM: 100M
 - MW: 100M
 - LW: 100M
 - SW: 200M
 - SSB: 200M
 - AIR: 100M
- 1200 memories for 12 memory pages (each page 100 memories)

9. Alarm Mode: alarm by radio only (2 presettings)

10. Quiescent Current

- FM < 50mA
- MW/LW < 70mA
- SW < 70mA
- SSB < 70mA
- AIR < 70mA
- Standby < 80uA

11. Speaker: Φ 77 mm / 16 Ohm / 1W Cone speaker

12. Earphone Jack: Φ 3.5mm, 32 Ohm, Stereo type

13. Power supply:

- Battery: UM3 or AA X 4
- External adaptor: DC 6V, \geq 300mA

14. Unit Dimensions: approx. 188(W) X 116(H) X 31(D) mm

15. Weight: 475g (Batteries not included)