



Made by: Quanzhou Wouxun Electronics Co., Ltd.
Add: #38 Yuantai 1st Road, Jiangnan High Technology Industry Park,
Licheng District, Quanzhou 362000, Fujian, China
[Http://www.wouxun.com](http://www.wouxun.com)



Professional USER'S MANUAL Mobile Transceiver

16.2x11cm

Thanks for buying the mobile radio.

This mobile radio offers latest design, enhanced features, solid performances and easy accessibility. We believe you will be pleased with the high quality and reliable features for all your communication needs.

Read this important information on the safe and efficient operation before using mobile radio.

Safety information

The mobile radio is an electrical apparatus, as well as a generator of RF(Radio Frequency) energy, and you should exercise all safety precautions as are appropriate of this type of device. These safety tips apply to any device installed in a well-desi-gned amateur radio station.

- ⚠ Explosive atmospheres(gases, dust, fumes, etc.). Turn OFF your mobile radio while taking on fuel or while parked in gasoline service stations. Do not carry spare fuel containers in the trunk of your vehicle if your mobile radio is mounted in the trunk area.
- ⚠ Injury from radio frequency transmissions. Do not operate your mobile radio when somebody is either standing near to or touching the antenna, to avoid the possibility of radio frequency burns or related physical injury.
- ⚠ Dynamite blasting caps. Operating the mobile radio within 150m(500 feet) of dynamite blasting caps may cause them to explode. Turn OFF your mobile radio when in a area where blasting is in progress, or where "TURN OFF TWO-WAY RADIO" signs have been posted. If you are transporting blasting caps in your vehicle, make sure they are carried in a closed metal box with a padded interior. Do not transmit while the caps are being placed into or removed from the container.
- ⚠ Never allow unsupervised children to play in the vicinity of your mobile radio or antenna installation.

- ⚠ Be certain to wrap any wire or cable splices thoroughly with insulating electrical tape, to prevent short circuits.
- ⚠ Do not route cables or wires through door jambs or other locations where, through wear and tear, they may become frayed and shorted to ground or to each other.
- ⚠ Do not stand in front of a directional antenna while you are transmitting into that antenna. Do not install a directional antenna in any location where humans or pets may be walking in the main directional lobe of the antenna's radiation pattern.
- ⚠ In mobile installations, it is preferable to mount your antenna on top of the roof of the vehicle, if feasible, so as to utilize the car body as a counterpoise for the antenna and raise the radiation pattern as far away from passengers as possible.
- ⚠ During vehicular operation when stopped (in a parking lot, for example), make it a practice to switch to Low power if there are people walking nearby.
- ⚠ Never wear dual-earmuff headphones while driving a vehicle.
- ⚠ Do not attempt to drive your vehicle while making a telephone call on an autopatch using the DTMF microphone. Pull over to the side of the road, whether dialing manually or using the auto-dial feature.

Safety information

Notice

- » All of the above advice is suited to the use of your mobile radio and its accessories. If they do not function normally, please get in touch with the dealer immediately.
- » If you use components or accessories not sold by Wouxun Company, Wouxun will not guarantee the safety and usability of the transceiver.

Contents

Structure Instructions	01-03
LCD	01
Front panel	03
Checking the equipment	04
Standard Accessories	04
Description of functions	05
Technical specifications	06
Pre-use installation	07-08
Transceiver installation	07
Connecting power source	09-10
Replacing the fuse	10
Antenna connection	11
Front panel installation	12-16
Install inclined switchboard panel	12
Install flat switchboard panel	13

Contents

Front panel and main station installation	13
Dismantling the front panel and transceiver	15
Installation of front panel support bracket	16
Accessories installation	17
Outer speakers	17
Hand microphone installation	17
Getting started	18-20
LCD	18
Back panel	19
Side panels	19
Hand microphone	20
Your first QSO	21-23
First QSO	21
Adjusting the volume	22
Selecting Frequency	23

Function description	24-62
Optional accessories	63
Troubleshooting	64
Announcement	65

Structure Instructions

LCD

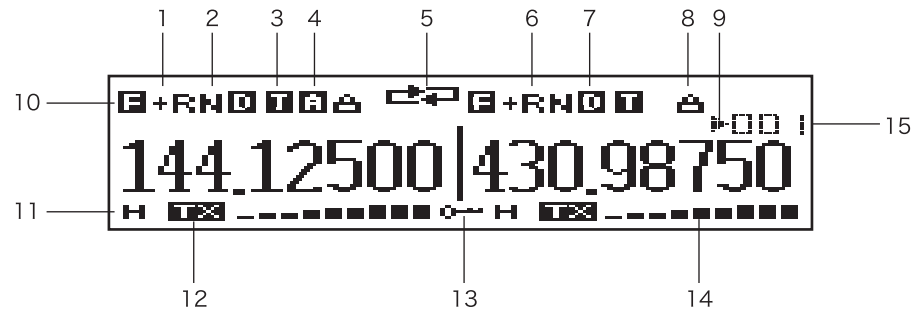

1. "+" Higher than received frequency dispersion, "-" Lower than received frequency dispersion
2. Narrow bandwidth
3. DTMF mute
4. AM-setting
5. Cross-band repeater function(Combined repeater function)
6. Reverse frequency
7. DCS ("C" means CTCSS)

8. Voice scrambling function
9. Priority channel indicator
10. Menu settings
11. High-power transmission ("M" means Medium-power transmission, "L" means Low-power transmission)
12. Repeater transmitter ("RX" means Repeater receiver)
13. Keyboard locking
14. Signal strength indicator
15. Channel number sequence/Function menu sequence

Structure Instructions

Front panel

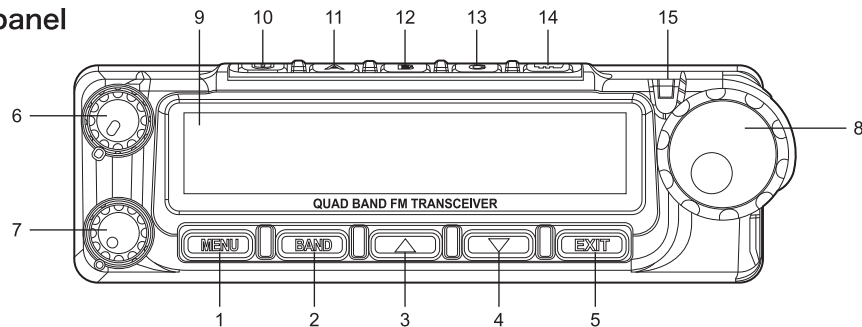

- | | |
|------------------------------------|--|
| 1. Function keys/enters keys | 9. LCD |
| 2. Master frequency set up hot key | 10. Power switch button |
| 3. Up key | 11. Hot key "A" (See hot key operation 48) |
| 4. Down key | 12. Hot key "B" (See hot key operation 49) |
| 5. Exit/Cancel key | 13. Hot key "C" (See hot key operation 50) |
| 6. "A" area volume control | 14. Keyboard lock key |
| 7. "B" area volume control | 15. Status indicator light |
| 8. Channel encoder | |

Checking the equipment

Carefully unpack the transceiver. We recommend that you identify the items in the following table before discarding the packing material.

If any item is missing or has been damaged during shipment, please notify your dealer.

Standard Accessories

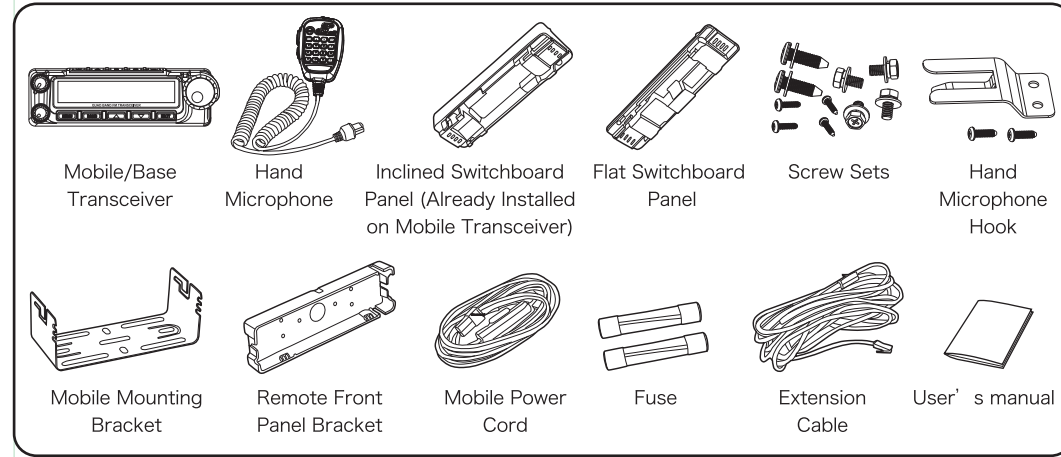

Description of functions

1. Full Duplex Cross-band repeater
2. Both Stations can Form Combined Same or Different Band (s) Repeat
3. Full Duplex Working Mode on A/B Areas (e.g.: A area transmitting and B area receiving at the same time, vice versa)
4. Dual Speaker & Dual Output
5. Same or Different Band (s) Simultaneous Reception: UU,VV,UV or VU
6. Dual Display (Large LCD Dual Frequency Display, two Completely Independent Operating Systems)
7. Over 999 Memory Channels (Area Scanning Management)
8. Remote-head Mounting Capacity (Multiple Installation Types, Convenient Usage)
9. UV or VU Duplex Cross-band Repeat (Offset Frequency Programmable)
10. Air Band Receiving Function & AM Mode Receiving Capacity
11. CTCSS/DCS Encoding & Decoding, CTCSS/DCS Scanning
12. Multiple Speaker Output Settings
13. DTMF Hand Microphone with Speaker, TX/RX Indicator and Volume Controller
14. Incoming (Caller) ID Display
15. DTMF Encoding & Decoding
16. Group Calls, All Calls and Selective Calls
17. 8 Groups Scrambler
18. Priority Channel Scanning
19. APO Power Management
20. Bandwidth Selectable
21. Chinese/English Voice Guide
22. Automatic Temperature Testing
23. Minimum Operating Voltage Settings
24. Stun and Kill Function
25. 2100Hz / 1750Hz / 1450Hz / 1000Hz Single Tone Pulse Frequency (Used when activating repeater signal)
26. Three Colors Backlight Selectable
27. Remote Control Setting
28. Frequency / Channel Scanning with CTCSS / DCS Detection
29. Multiple Cooling Ways
30. Simultaneous Scanning on AB Areas

Note: Different countries or areas are differing from the specific applicable working frequencies and parameters.

Technical specifications

General		Receiver	Wide bandwidth	Narrow bandwidth
Frequency Range	Frequency Range Suitable for any Region of any Country:	Adjacent Channel Selectivity	≤ 70dB	≤ 60dB
Step Frequency	5KHz / 6.25KHz / 10KHz / 12.5KHz / 20KHz / 25KHz / 30KHz / 50KHz / 100KHz	Intermodulation	≤ 65dB	≤ 60dB
		Spurious Response	≤ 70dB	≤ 70dB
Memory Channels	999	Audio Response	+1~-3dB(0.3~3KHz)	+1~-3dB(0.3~2.55KHz)
Work Mode	F2D / F3E	Signal to Noise Ratio	≥ 45dB	≥ 40dB
		Audio Distortion	≤ 5%	
Operating Temperature	-20°C~+40°C	Audio Power	Transceiver ≤ 3W Hand Microphone ≤ 1W	
Antenna Impedance	50Ω	Sensitivity	400.000-479.995MHz: 0.25uV(13dB SINAD)	
Power Requirement	13.8VDC ± 15% (Negative Grounded)		136.000-174.995MHz: 0.25uV(13dB SINAD)	
Weight	1437.8g (including microphone)		50.000-53.995MHz: 0.25uV(13dB SINAD)	
Dimensions	140 x 44 x 207 (mm)		26.000-29.995MHz: 0.25uV(13dB SINAD)	
			320.000-349.995MHz: 0.25uV(13dB SINAD)	
			700.000-985.995MHz: -97.0dBm(13dB SINAD)	

Transmitter	Wide bandwidth	Narrow bandwidth	Transmitter	Wide bandwidth	Narrow bandwidth
Type of Modulation	16K F3E	11K F3E	Max. Frequency Deviation	± 5KHz	± 2.5KHz
Adjacent Channel Power	≥ 70dB	≥ 60dB	Frequency Stability	± 5ppm	
Spurious	≥ 60dB	≥ 60dB	Audio Distortion	≤ 5%	
Audio Response	+1~-3dB(0.3~3KHz)	+1~-3dB(0.3~2.55KHz)			

Note: Different countries or areas are differing from the specific applicable working frequencies and parameters.

Pre-use installation

Transceiver installation

Choose a safe place inside your vehicle, one which would to the greatest extent reduce possible harm to passengers inside the car while the car is moving. It is recommended to install the transceiver on the lower part of the front meter gauge, it will prevent the transceiver from colliding with the driver in the in-stance of emergency or sudden braking. Install the transceiver in an area with good ventilation and avoid installing in a place with direct contact with the sun.

1. Use the supplied self-tapping screws to install the support bracket to the vehicle.

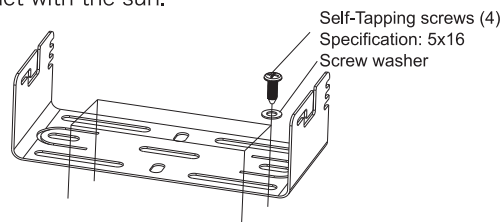

2. Set the transceiver in the bracket, then insert the supplied combined screws and tighten, insure that the screws are fastened tightly. This will insure the support bracket and the transceiver do not get bumped lose when the vehicle hits bumps or shakes.

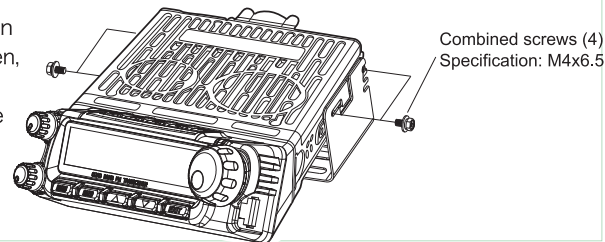

3. Use every screw slot along the side of the support bracket, you can set the transceiver to be installed at a different angle.

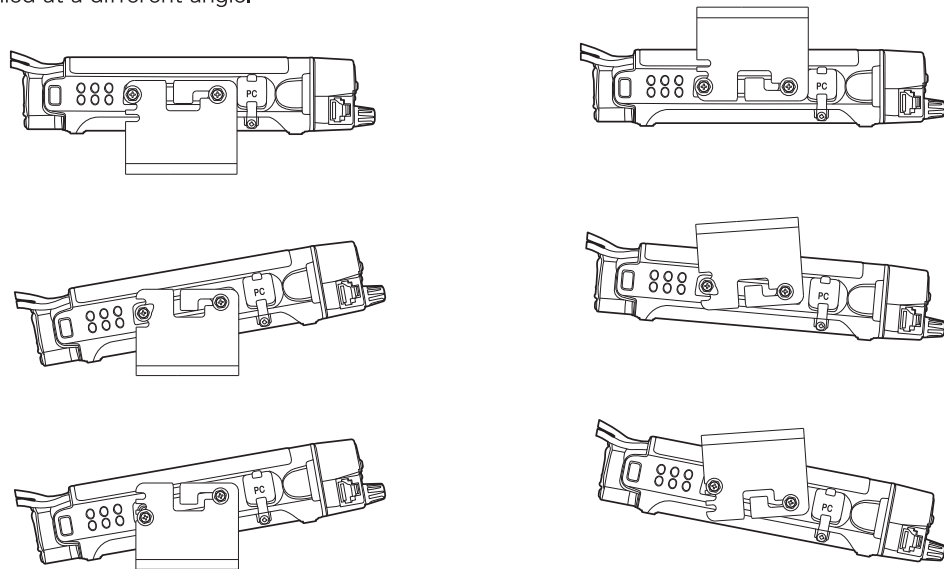

Connecting power source

The transceiver power source usage ranges from $13.8V \pm 15\%$. When your power source (or vehicle power source) reaches levels up to 16V, TX will be forbidden, however RX will operate as normal. When your power source (or vehicle power source) reaches levels as low as 11.5V, the transceiver will automatically shut off. So the transceiver does not exhaust the vehicles battery and affect the vehicles normal operation. (This feature is set by the Menu 38, see instruction on P49-50)

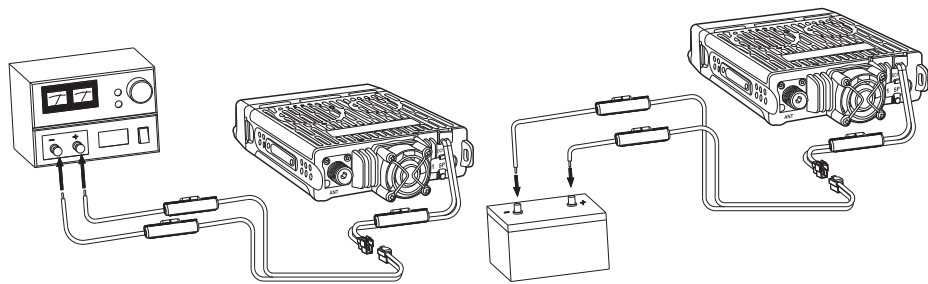

Special Reminder

» This transceiver's working voltage is $13.8V \pm 15\%$ DC.

■ Replacing the fuse

In the instance that the transceiver blows a fuse, first find out the reason, then solve the malfunction. If after installing the new fuse it once again blows a fuse, please sever the power source and immediately contact a local authorized dealer or service center for assistance.

The specified fuse current is 15A, The specified power source current is 20A and above. See the Fuse installation diagram on the right, after installation the fuse should be firmly secured to the copper set!

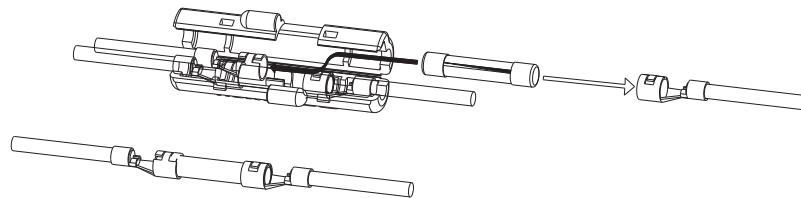

Antenna connection

Before operation, you must effectively install and adjust the antenna, installation success depends upon the type of antenna and whether or not the antenna is set up correctly. If you use the most suitable antenna and the antenna is installed correctly, the transceiver will attain the greatest results. The transceiver antenna's impedance is 50 ohms, if the impedance is not at 50 ohms it will reduce the performance of the transceiver and possibly interfere with nearby broadcasting stations as well as other antenna's receivers, it could even harm the transceiver.

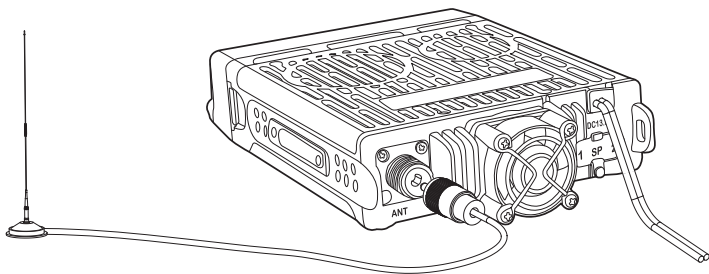

Front panel installation

The transceiver is supplied with two kinds of switchboard panels: Inclined switchboard panel and a flat switchboard panel.

■ Install inclined switchboard panel

(1) Lower alignment

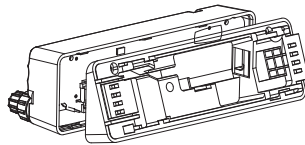

(2) Cover alignment

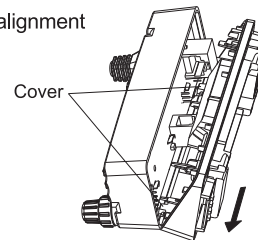

(3) Close in the direction shown by the arrows

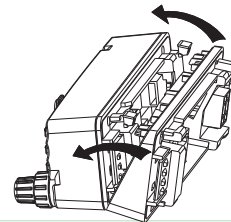

(4) Use the supplied screws to fasten

Self-Tapping screws
Specification: 2x16

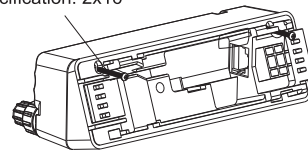

Front panel installation

■ Install flat switchboard panel

(1) Lower alignment

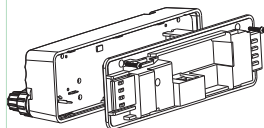

(2) Cover alignment

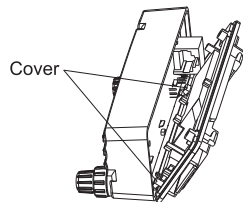

(3) Close in the direction shown by arrows

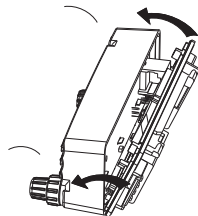

(4) Use the supplied screws to fasten

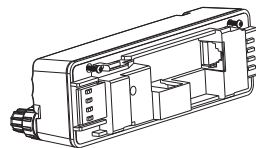

Self-Tapping screws (2)
Specification: 2x11

■ Front panel and main station installation

(1) Connect the cable to the transceiver's 8 point socket.

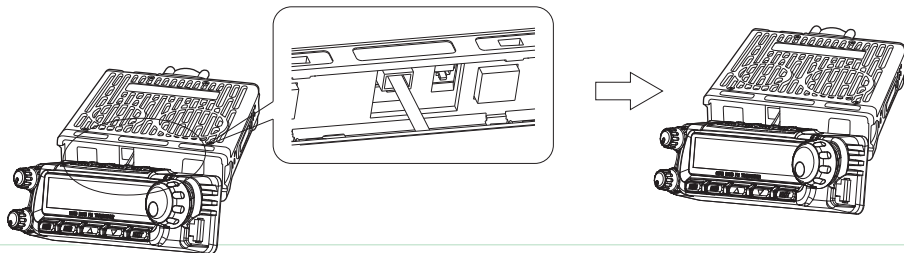

(2) Proceed according to the arrow shown.

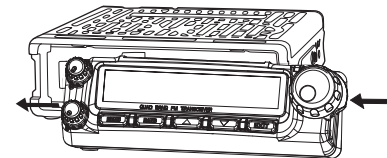

Connection method for transceiver station to operating front panel:

The vehicle transceiver connection line uses 8 facets and 8 lead conducting wires (diagram 1),

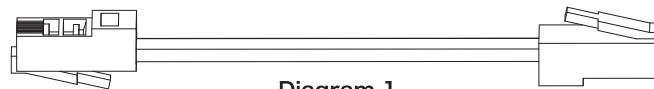
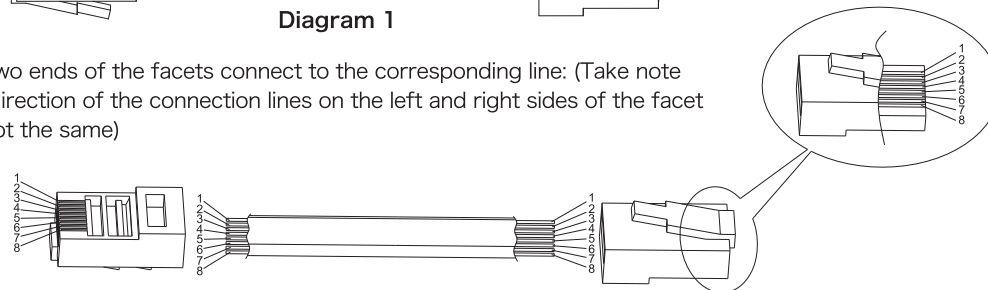

Diagram 1

The two ends of the facets connect to the corresponding line: (Take note that direction of the connection lines on the left and right sides of the facet are not the same)



Front panel installation

Left facet connection point 1	Connect through the conducting wire to right facet 1
Left facet connection point 2	Connect through the conducting wire to right facet 4
Left facet connection point 3	Connect through the conducting wire to right facet 3
Left facet connection point 4	Connect through the conducting wire to right facet 2
Left facet connection point 5	Connect through the conducting wire to right facet 5
Left facet connection point 6	Connect through the conducting wire to right facet 6
Left facet connection point 7	Connect through the conducting wire to right facet 7
Left facet connection point 8	Connect through the conducting wire to right facet 8

Therefore the conducting wires connection to the left facet is corresponding and the connection to the right facets 2 and 4 are swapped.

Special Reminder

» If the connection wires are not Company supplied or dealer approved, Company does not guarantee its safety and operational effectiveness!

■ Dismantling the front panel and transceiver

(1) Disconnect cover in the direction of the arrow

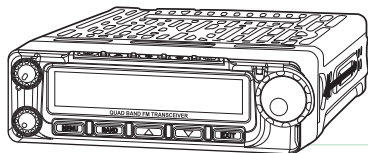

(2) Remove in the direction shown by the arrow

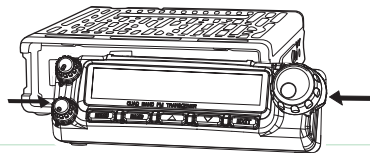

■ Installation of front panel support bracket

When the transceivers front panel is installed separately from the main platform, there is a supplied front panel support bracket designed especially for installation.

(1) First secure the support bracket with the supplied screws

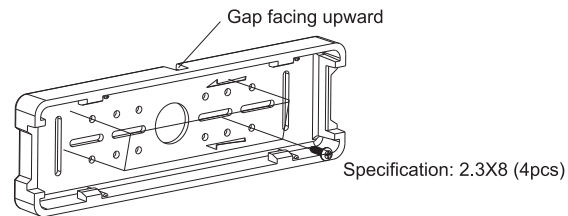

(2) First string the connection line through opening in the center of the support bracket, then close the bracket cover directly as shown by the arrows.

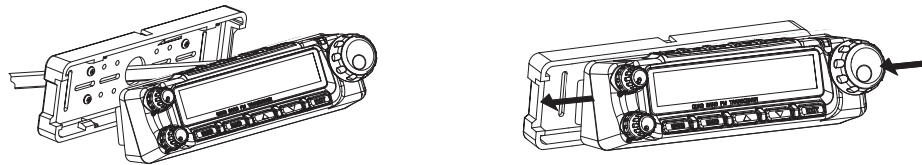

Accessories installation

Outer speakers

The external speaker jacks can be connected to a 3.5mm single outlet. There are two speaker outlets located on the back of the transceiver.

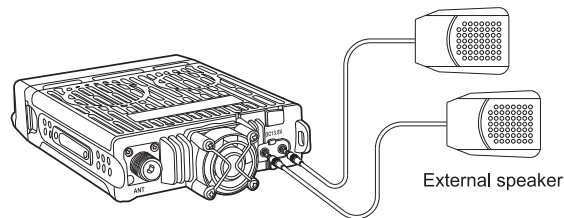

Hand microphone installation

The transceiver comes supplied with two different types of hand microphone:

Encoded hand microphone and unencoded hand microphone. Plug the connection cable into the 8 point socket located on the front panel.

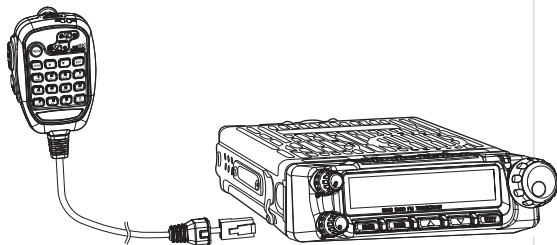

Getting started

LCD

All kinds of performance parameters can be selected on the LCD screen. Sometimes, you may be unable to think of what they mean or how to change them. The following table will be extremely useful at such times.

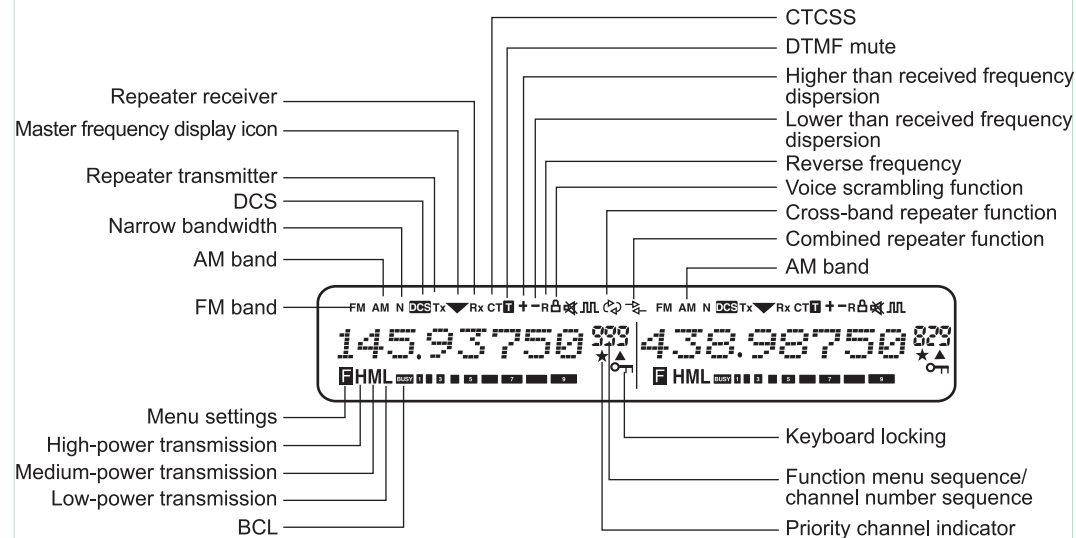

Getting started

Back panel

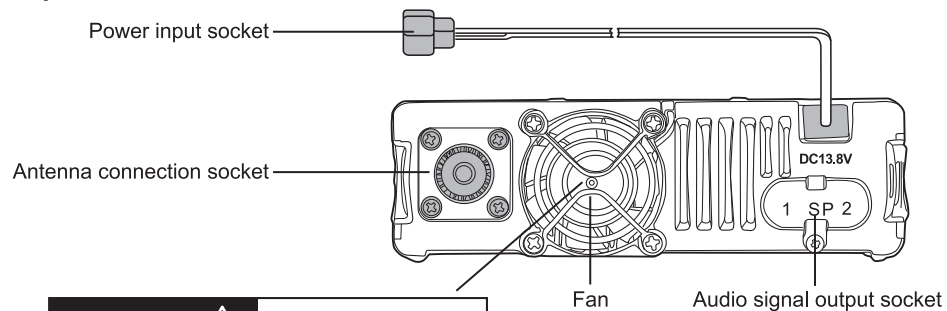

WARNING

» Hazardous moving parts, keep fingers and other body parts away.

Side panels

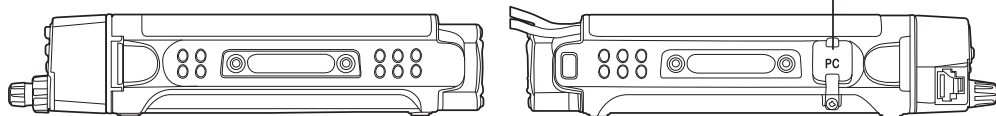

Hand microphone

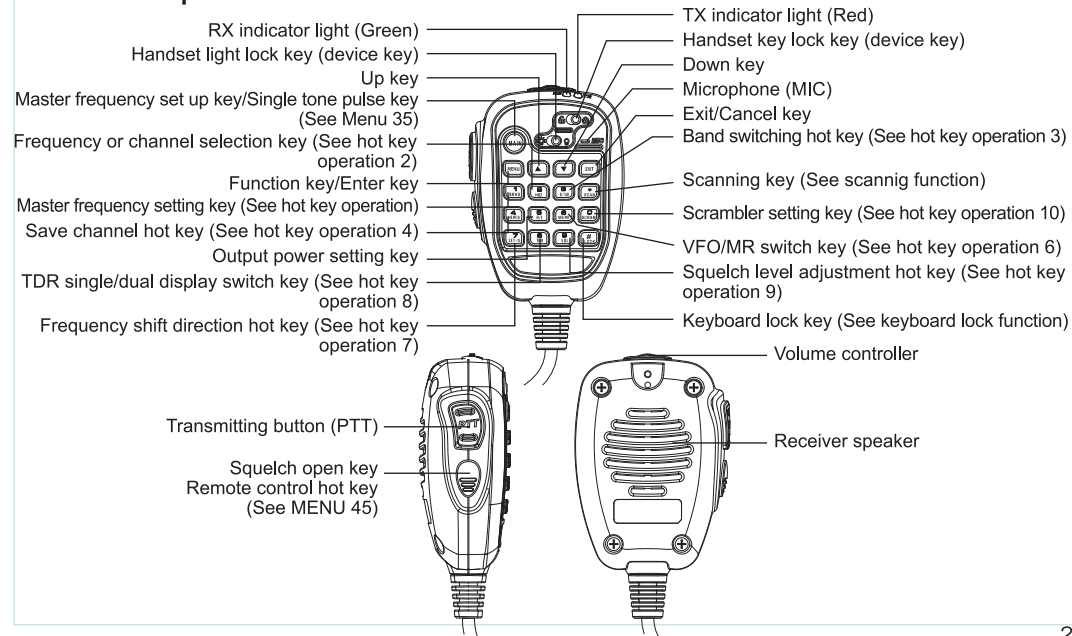

Your first QSO

First QSO

Do you want to hurry up and use your transceiver? After reading these chapters and sections you will know how to broadcast your voice out into the sky. Following is a quick instruction manual. If you encounter any problems or need further explanation, please read the detailed explanation later in this manual.

1. Installing the transceiver. (See pre-usage installation)
2. Installing the antenna. (See pre-usage installation)
3. Connecting the power source, or vehicle power source. (See pre-usage installation)
4. Press  to turn on the transceiver, the transceiver will make a long double beeping tone, the transceivers brand and model will be displayed and the transceiver will enter standby status.

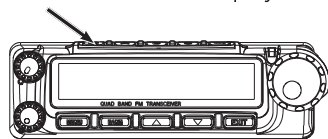

Press the key shown by the arrow

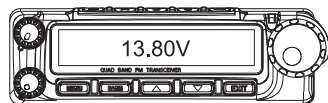

Display brand and model

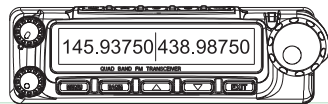

Enter standby status

Adjusting the volume

Rotate the VOL1 and VOL 2 knobs clockwise in order to increase the volume, rotate the knobs counter-clockwise to decrease volume, the corresponding volume level will be displayed on the LCD. The volume control knobs have upper and lower control devices. The upper control device is the channel and frequency RX volume control on the left side of the screen, the lower level control device is the channel and frequency RX volume control on the right side of the screen.

Turn the volume knob clockwise to increase the volume and the RX volume. The maximum volume is level 16. Turn the knob counter-clockwise to decrease the volume and the RX volume. Continue turning the knob counter-clockwise to shut off.

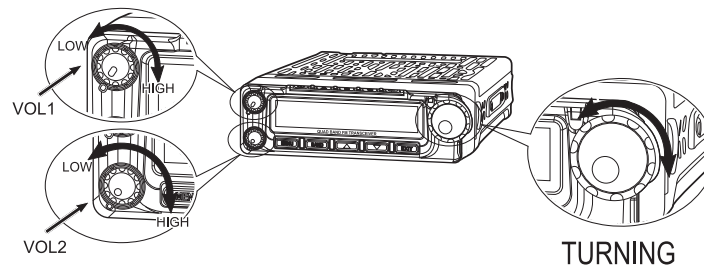

Your first QSO

Selecting Frequency

(1) Frequency mode (VFO)

VFO Mode is the basic mode for changing the operating frequency, through rotating the TURNING (Tuning) control knobs you can change the operating frequency. Turn the knobs clockwise to increase the frequency and counter-clockwise to decrease.

You can also enter the desired frequency using the keypad.

Changing the operating frequency using the keypad:

While in standby mode, press the

- (2) key to enter in the operating frequency selection. After the LCD screen displays 8 whiffletrees, enter in the 6 figures in order which the frequency will automatically confirm according to the “frequency automated correction” verification. And will then display on the LCD screen.

Function description

Please use the matching hand microphone with keypad for the following operations.

Step frequency settings (STEP) - Menu 1

Function: VFO frequency setting to adjust steps

Selectable: 2.5K/5K/6.25K/10K/12.5K/20K/25K/30K/50K/100K

Default: 5K

When the transceiver is standby, press the **MENU** + **1 BRAND** keys and the screen will display: 

Press the **MENU** key to access the menu, and after pressing the **▲** / **▼** key to select the required step frequency type, press the **MENU** key to confirm, and the **EXIT** key to return to standby.

This transceiver has 9 types of step frequency: 5KHz, 6.25K, 10KHz, 12.5KHz, 20KHz, 25KHz, 30KHz, 50KHz, 100KHz.

Wide/Narrow bandwidth settings (W/N) - Menu 2

Function: Choose Wide/Narrow bandwidth to adjust microphone frequency offset

Selectable: Wide/Narrow bandwidth

Default: Wide bandwidth

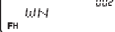
When the transceiver is standby, press the **MENU** + **2 MHz** keys and the screen will display: 

Press the **MENU** key, then Press the **▲** / **▼** keys to choose the desired wide/narrow bandwidth set up and press the **MENU** key to confirm. Press the **EXIT** key to return to standby mode.

This transceiver's bandwidth settings are divided into: wide bandwidth (25KHz) and narrow bandwidth (12.5K).

Function description

Two medium level power settings (MPOW-SET) - Menu 3

Function: Two medium level power setting

Selectable: MPOW-1/MPOW-2

Default: MPOW-1

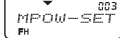
When the transceiver is standby, press the **MENU** + **3** **B/SW** keys and the screen will display: 

Press the **MENU** key, then press the **▲** / **▼** to choose the required output level, and press the **▲** key to confirm. Press the **EXIT** key to return to standby mode.

This transceiver has to medium level power set ups separated as MPOW1:20W ; MPOW2:10W.

Special Reminder

» Medium output power settings is a system setting, after changing these settings, the vehicle transceivers two operating frequencies medium output power settings will simultaneously be set.

Offset frequency settings (OFF-SET) - Menu 4

Function: Offset frequency settings

Selectable: Range “0-999.99500MHz”

Default: 0

When the transceiver is standby, press the **MENU** + **4** **MEMCH** keys and the screen will display: 

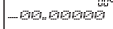
Press the **MENU** key to access the menu, and the screen will display: 

And the first digit will simultaneously flash, after inputting the required offset frequency or pressing the **▲** / **▼** keys to increase or reduce the offset frequency, press the **MENU** key to confirm, and press the **EXIT** key to return to standby.

The transceiver's frequency range is from 0-599.99500MHz, and the KHz of input offset frequency will be automatically confirmed by step frequency.

This function can be prohibited while the vehicle transceiver is in cross-band repeater or repeater receiver or repeater transmitter mode.

Transmssion prompt settings (ROGER) - Menu 5

Function: Transmission begins and end prompt

Selectable: OFF/BOT/EOT/BOTH

Default: OFF

When the transceiver is standby, press the **MENU** + **5** **H/L** keys and the screen will display: 

Press the **MENU** key to access the menu, and after pressing the **▲** / **▼** keys to choose the required prompt mode, press the **MENU** key to confirm, or the **EXIT** key to return to standby.

The transceiver features 4 kinds of prompt: BOT (beginning of transmission), EOT (end of transmission), BOTH (beginning and end of transmission, and OFF (prompts deactivated).

Function description

ROGER Dual tone prompt method, can be set through the supplied programming software. It can be set through (at most 6 digit number) as well as remaining mode or in intervals. (See programming software for help)

Beep prompt settings (BEEP) - Menu 6

Function: Prompts for radio operation error or fault.

Selectable: ON/OFF

Default: ON

When the transceiver is standby, press the **MENU** + **6** (VFO/MR) keys and the screen will display: 

Press the **MENU** key to access the menu, and after pressing the **▲** / **▼** keys to choose the required voice prompt to confirm, press the **EXIT** key to return to standby mode.

The transceiver has 2 Beep Prompt modes: ON or OFF

Voice prompt settings (VOICE) - Menu 7

Function: Menu operation prompts

Selectable: ON/OFF

Default: ON

When the transceiver is standby, press the **MENU** + **7** (SET-D) keys and the screen will display: 

Press the **MENU** key to access the menu, and after pressing the **▲** / **▼** keys to choose the required prompt mode, press the **MENU** key to confirm, or the **EXIT** key to return to standby.

This transceiver has 3 voice prompt settings: CHINESE, ENGLISH, and OFF.

Special Reminder

» If you need to turn all prompts off, you must turn off both the setting of voice prompt (Menu 7) and the beep prompt (Menu 6).

Busy channel lock-out (BCL) - Menu 8

Function: Enabled this function, will prevent other stations which is communicating and if the selected channel is being occupied by other users, the PTT radio will not be transmitted at this time.

Selectable: ON/OFF

Default: ON

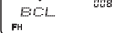
When the transceiver is standby, press the **MENU** + **8** (TOR) keys and the screen will display: 

Press **MENU** the key to access the menu, and after pressing the **▲** / **▼** keys to choose the required prompt mode, press the **MENU** key to confirm, or the **EXIT** key to return to standby.

The transceiver has 2 BCL modes: ON (activate) and OFF (deactivate).

Function description

Mute settings (SP-MUTE) - Menu 9

Function: Mute settings

Selectable: QT / QT + DTMF / QT * DTMF

Default: QT

QT: All signals on the same CTCSS frequency will activate the speaker

QT+DTMF: Only those signals which both satisfy the requirements of CTCSS mode and whose dual-tone multi-frequency carrier wave signal also match the transceiver will activate the speaker in this mode.

QT*DTMF: When this mode is active, only those signals which either meet QT requirements or DTMF requirements will activate the speaker.

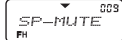
When the transceiver is standby, press the **MENU** + **SQL** keys and the screen will display: 

Press **MENU** the key to access the menu, and after pressing the **▲** / **▼** keys to choose the required prompt mode, press the **MENU** key to confirm, or the **EXIT** key to return to standby.

Squelch settings: set the conditions which determine when the speaker shall be turned on, these settings are used during selective calling, group calling and all calling.

The Transceiver's mute mode include:

QT: when the transceiver is set to this mode, all signals on the same CTCSS frequency will activate the speaker.

QT+DTMF: only those signals which both satisfy the requirements of CTCSS mode and whose dual-tone

multi-frequency carrier wave signal also match the transceiver will activate the speaker in this mode.
QT*DTMF : When this mode is active, only those signals which either meet QT requirements or DTMF requirements will activate the speaker.

A. Used in All call: Press PTT to transmit, after send out the transceiver's ID code, press ***SCAN** + **#LOCK**.

B. Used in Group call: Press PTT to transmit, after send out the transceiver's ID code, press [Group Number] + ***SCAN** + **#LOCK**.

Note: Group number refers to the first digit ID code. If some transceivers with the same first digit ID code, then they are in the same group. The first digit can be set from 1–9, means there are 9 groups maximum. See the detailed instructions on MENU 15 (ANI-EDIT).

C. Used in Selective call: Press PTT to transmit, after send out the transceiver's ID code, input the specified selective call's ID code.

Scan mode settings (SC-REV) - Menu 10

Function: Scan mode settings

Selectable: TO/CO/SE

Default: SE

TO: After finding a carrier wave signal, scanning will continue if no operations are carried out within 5 seconds.

CO: Scanning will stop when a carrier wave signal has been found, and scanning will continue if the carrier wave signal is lost for 3 seconds.

Function description

SE: Scanning will stop when carrier wave signal is found and press PTT key or function key to store it.

When the transceiver is standby, press the **MENU** + **1 BAND** + **SCRAM** keys and the screen will display: 

Press the **MENU** key to access the menu, and after pressing the **▲** / **▼** keys to select the required setting, press the **MENU** key to confirm, and the **EXIT** key to return to standby.

The transceiver has 3 scan modes: TO, CO, and SE:

TO: after finding a carrier wave signal, scanning will continue if no operations are carried out within 5 seconds.

CO: scanning will stop when a carrier wave signal has been found, and scanning will continue if the carrier wave signal is lost for 3 seconds.

SE: scanning will stop when a carrier wave signal is found.

Special Reminder

- » This function is prohibited if the transceiver is in Cross-band repeat or Repeater relay or Repeater transmitter mode.
- » If you prefer to ignore the CTCSS/DCS settings when scanning frequency/channel, please set 'SCAN-DET (Scanning CTCSS/DCS detection)' OFF via programming software under the configuration settings column.

Transmission time-out timer (TOT) - Menu 11

Function: When the transmission time exceeds the time set by the "Timeout Timer", there is an error tone. Stop transmitting within 10 seconds, press **PTT** will not be able to transmit, and there will be

an error prompt. The transmission function will restore after 10 seconds.

Selectable: 1MIN / 2MIN—60MIN

Default: 2MIN

When the transceiver is standby, press the **MENU** + **1 BAND** + **1 BAND** keys and the screen will display: 

Press the **MENU** key to access the menu, and after pressing the **▲** / **▼** keys to select the required time, press the **MENU** key to confirm, and the **EXIT** key to return to standby.

The TOT can be set for up to 60 minutes, 1 level of the setting corresponding to 1 minute.

Transmission overtime alarm (TOA) - Menu 12

Function: Prompt settings before reach "TOT"

Selectable: OFF/BOT/EOT/BOTH

Default: 5S

When the transceiver is standby, press the **MENU** + **1 BAND** + **2 MHZ** keys and the screen will display: 

Press the **MENU** key to access the menu, and after pressing the **▲** / **▼** keys to select the required time, press the **MENU** key to confirm, and the **EXIT** key to return to standby.

The TOA has a maximum length of 10 seconds, each level corresponding to 1 second.

OFF: Deactivate TOA.

Function description

Special Reminder

» When the transmission time exceeds the “Time-out timer” set time, a continuous error tone will prompt, release the [PTT] key to stop it. The transmission function will be stopped for 10 seconds and it can not transmit by pressing the [PTT] key, simultaneously a double tone will prompt. After 10 seconds, the transmission function will be restored (Transmission time-out punishment).

Caller ID transmission settings (ANI-SW) - Menu 13

Function: Caller ID transmission settings

Selectable: ON/OFF

Default: OFF

When the transceiver is standby, press the **MENU** + **1** (BRND) + **3** (B/SW) keys and the screen will display: 

Press the **MENU** key to access the menu, and after pressing the **▲** / **▼** keys to select the required setting, press the **MENU** key to confirm, and the **EXIT** key to return to standby.

Caller ID transmission: ON activate, OFF deactivate.

Ring time (RING) - Menu 14

Function: Make prompts when DTMF have been decoded.

Selectable: OFF/1S–10S

Default: 3S

When the transceiver is standby, press the **MENU** + **1** (BRND) + **4** (MEMCH) keys and the screen will display:  Press the **MENU** key to access the menu, and after pressing the **▲** / **▼** keys to select the required time, press the **MENU** key to confirm, and the **EXIT** key to return to standby.

The transceiver has 10 levels of ring time, each corresponding to 1 second. OFF: ring deactivated.

Editing caller ID (ANI-EDIT) - Menu 15

Function: This transceiver's caller ID is composed of the Arabic numbers 0–9, the first digit can not be 0, and ID numbers can be as short as 3 digits and as long as 6 digits.

Selectable: 0–9

Default: 101

The transceiver's caller ID is composed of the Arabic numerals 0–9: the first digit cannot be 0, and ID numbers can be as short as 3 digits and as long as 6.

When the transceiver is standby, press the **MENU** + **1** (BRND) + **5** (H/L) keys and the screen will display: 

Press the **MENU** key to access the settings menu, and after inputting the required digits.

Press the **MENU** key to confirm, and the **EXIT** key to return to standby.

Example 1: editing a 6–digit caller ID number (901285)

When the transceiver is standby, press the **MENU** + **1** (BRND) + **5** (H/L) keys and the screen will display: 

After pressing the **MENU** key, the first digit will flash, then input the required value **9** (SQL) **0** (SCRAM) **1** (BRND) **2** (MHZ) **8** (TOR) **5** (H/L).

Press the **MENU** key to confirm, and press the **EXIT** key to return to standby.

Function description

Example 2: editing a 3-digit caller ID number (901)

When the transceiver is standby, press the **MENU** + **1** (BRND) + **5** (H/L) keys and the screen will display: 

After pressing **MENU** the key, if a caller ID number has already been input, it will be displayed, and the first digit will flash. If no caller ID number has been input, 101 will be displayed, and the first digit will flash, input **9** (SQL) **0** (SCRAM) **1** (BRND) , and after the third digit has been input, the symbol "<" will flash in the 4th digit, press the **MENU** key to confirm, and the **EXIT** to return to standby.

Special Reminder

» Each transceiver can have only one caller ID number, which is shared by Areas A and B.

DTMF sidetone settings (DTMFST) - Menu 16

Function: Caller ID and keypad sidetone setting

Selectable: OFF/DT-ST/ANI-ST/DT+ANT

Default: DT/ST

When the transceiver is standby, press the **MENU** + **1** (BRND) + **6** (VFO/MR) keys and the screen will display: 

Press the **MENU** key to access the menu, and after pressing the **▲** / **▼** keys to select the required setting, press the **MENU** key to confirm, and the **EXIT** key to return to standby.

The transceiver has the following DTMF modes; 1. DT-ST: Keypad sidetone will be activated when transmitting;

2. ANI-ST: caller ID sidetone will be activated when transmitting ; 3. DT+ANI:keypad and caller ID sidetone are both activated when transmitting.

Caller ID transmission mode (PTT-ID)- Menu 17

Function: ID transmission selected

Selectable: BOT/EOT/BOTH

Default: BOT

When the transceiver is standby, press the **MENU** + **1** (BRND) + **7** (SET-D) keys and the screen will display: 

Press the **MENU** key to access the menu, and after pressing the **▲** / **▼** keys to select the required setting, press the **MENU** key to confirm, and the **EXIT** key to return to standby.

The transceiver features 3 kinds of ID transmission: BOT (beginning of transmission), EOT (end of transmission), BOTH (beginning and end of transmission).

Transmission backlight (TX-LED)- Menu 18

Function: Color of LED indicator settings

Selectable: OFF/RED/ORG/GREEN

Default: RED

When the transceiver is standby, press the **MENU** + **1** (BRND) + **8** (TOR) keys and the screen will display: 

Press the **MENU** key to access the menu, and after pressing the **▲** / **▼** keys to select the required

Function description

backlight color, press the **MENU** key to confirm, and the **EXIT** key to return to standby.
The transceiver has 3 backlight colors: BLUE; GREEN; WHITE; OFF: Deactivate.

Standby backlight (WT-LED) - Menu 19

Function: Standby backlight settings

Selectable: OFF/RED/ORG/GREEN

Default: ORG

When the transceiver is standby, press the **MENU** + **1** **BAND** + **9** **SQL** keys and the screen will display: 

Press the **MENU** key to access the menu, and after pressing the **▲** / **▼** keys to select the required backlight color, press the **MENU** key to confirm, and the **EXIT** key to return to standby.

The transceiver has 3 backlight colors: BLUE; GREEN; WHITE; OFF: Deactivate.

Receiving backlight (RX-LED) - Menu 20

Function: Receiving backlight settings

Selectable: OFF/RED/ORG/GREEN

Default: GREEN

When the transceiver is standby, press the **MENU** + **2** **MHZ** + **0** **SCRAM** keys and the screen will display: 

Press the **MENU** key to access the menu, and after pressing the **▲** / **▼** keys to select the required backlight color, press the **MENU** key to confirm, and the **EXIT** key to return to standby.

The transceiver has 3 backlight colors: BLUE; GREEN; WHITE; OFF: Deactivate.

Deleting a channel (DEL-CH) - Menu 21

Function: Deleting unneed channel

Selectable: 999 channels

Default: CH-001

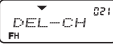
When the transceiver is standby, press the **MENU** + **2** **MHZ** + **1** **BAND** keys and the screen will display: 

Press the **MENU** key to access the menu, and after pressing the **▲** / **▼** to select the channel you wish to delete or manually inputting the channel code, press the **MENU** key to confirm and the **EXIT** key to return to standby.

Special Reminder

» The 1st, 2nd and the Priority Channels are fixed channels and cannot be deleted.

Editing a channel name (CH-NAME) - Menu 22

Function: Edited channel names, press up key to choose the required character, press down key to edit the next characters, and press the **【*】** to clean the character you are currently editing, When you finished editing the name, press **【MENU】** to confirm.

Selectable: 8Characters

Default: None

Function description

Channel names can only be edited in channel mode, and only the name of the present channel can be edited—this operation is ineffective in frequency mode.

When the transceiver is standby, press the **MENU** + **2** **MHZ** + **2** **MHZ** keys and the screen will display: 

Press the **MENU** key to access the menu, and the first digit will flash (which indicates that this digit is being edited)

Press the **#** **LOCK** key to switch character sets (this switches between special characters, upper-case letters, lower-case letters, and numbers), press the **▲** key to choose the required character, press **▼** to edit the next character, and press *** SCAN** to clear the character you are currently editing.

When you have finished editing the name, press **MENU** to confirm, and press **EXIT** to exit the editing screen.

Note: 1. Channel names can be a maximum of 8 characters long, and the first character may not be 0.

2. When all 8 characters are empty, the channel will be displayed on the screen as CH-*** (** being the current channel number).

3. This function will be prohibited if the other area in scanning mode or the transceiver is not working in radio mode.

Priority channel switch (PRICH-SW) - Menu 23

Function: Switch on or off priority channel function. Switch on this function, will scan the channel every 3 seconds.

Selectable: ON/OFF

Default: OFF

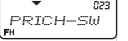
When the transceiver is standby, press the **MENU** + **2** **MHZ** + **3** **B/SW** keys and the screen will display: 
Press the **MENU** key to access the settings, and after pressing the **▲** / **▼** key to activate or deactivate the speaker, press the **MENU** to confirm, and press the **EXIT** key to return to standby

The priority channel switch can be set to ON or OFF.

Special Reminder

- » While in frequency mode or channel mode, you only need to turn on the priority channel, and the priority channel will scan in 3 second intervals. The priority channel is only used for receiving, if you need to transmit, please set the priority channel as the present channel.
- » If the master frequency is in Area A, the priority channel can be set as any band and can receive, while if the master frequency is Area B, the priority channel can only be set as UHF or VHF, if set other bands then cannot receive. Example, if the priority channel is 50MHz band, then it can be only in A area can receive, if in Area B, cannot receive.
- » This function will be prohibited if the transceiver is not working in radio mode.

Speaker settings (SPK-CONT) - Menu 24

Function: Select hand microphone or radio body as speaker.

Selectable: SPK1/SPK2/SPK1+2

Default: SPK1

Function description

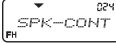
When the transceiver is standby, press the **MENU** + **2** (MHZ) + **4** (MEMCH) keys and the screen will display:  Press the **MENU** key to access the menu, and after pressing the **▲** / **▼** keys to select the desired setting, press the **MENU** key to confirm, and press the **EXIT** key to return to standby.

There are 3 speakers on the transceiver, 2 are for the transceiver that is separated by Area A/B and 1 is for hand microphone. You can activate the hand microphone as the only one speaker. You can also both activate the transceiver and hand microphone.

SPK1: only the transceiver unit speaker is activate.

SPK2: only the hand microphone is activate.

SPK1+2: the transceiver-mounted speaker and the hand microphone are both activate.

Keypad autolock (AUTOLOCK) - Menu 25

Function: Choose the type of keypad lock

Selectable: ON/OFF

Default: OFF

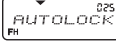
When the transceiver is standby, press the **MENU** + **2** (MHZ) + **5** (H/L) keys and the screen will display:  Press the **MENU** key to access the menu, and after pressing the **▲** / **▼** keys to select the desired setting, press the **MENU** key to confirm, and press the **EXIT** key to return to standby.

Receiving CTCSS settings (RX-CTC) - Menu 26

Function: Receiving CTCSS settings

Selectable: OFF/50 groups standard CTCSS/Non-standard CTCSS: 65.0–255.0MHz

Default: OFF

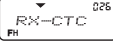
When the transceiver is standby, press the **MENU** + **2** (MHZ) + **6** (VFO/MR) keys and the screen will display:  Press the **MENU** key to access the menu, and after pressing the **▲** / **▼** key to select the CTCSS you desire, press the **MENU** key to confirm, and press the **EXIT** key to return to standby.

Standard CTCSS: 50 groups; Non-standard CTCSS: 65.0Hz–255.0Hz; OFF: Deactivate.

Receiving DCS settings (RX-DCS) - Menu 27

Function: Receiving DCS settings

Selectable: OFF/105 groups standard negative&positive DCS/Non-standard DCS: D000N–D766I

Default: OFF

- (1) The non-standard DCS code is from 000–766 except any code with 8 or 9 number. (Such as 680.719 is not the legal non-standard DCS code)
- (2) After set the non-standard DCS code, you can press **【 # 】** to select the Positive or Negative code, and then press **【 Menu 】** to confirm.

When the transceiver is standby, press the **MENU** + **2** (MHZ) + **7** (SET-D) keys and the screen will display: 

Function description

Press the **MENU** key to access the menu, and after pressing the **▲** / **▼** key to select the DCS you desire, press the **MENU** key to confirm, and press the **EXIT** key to return to standby.

Standard negative & positive DCS: 105 groups; Non-standard DCS: D000N–D766I; OFF: Deactivate.

Transmitting CTCSS settings (TX-CTC) - Menu 28

Function: Transmission CTCSS settings

Selectable: OFF/50 groups standard CTCSS/Non-standard CTCSS:65.0–255.0MHz

Default: OFF

When the transceiver is standby, press the **MENU** + **2** **MHZ** + **8** **TDR** keys and the screen will display: 

Press the **MENU** key to access the menu, and after pressing the **▲** / **▼** key to select the CTCSS you desire, press the **MENU** key to confirm, and press the **EXIT** key to return to standby.

Standard CTCSS: 50 groups; Non-standard CTCSS: 65.0Hz–255.0Hz; OFF: Deactivate.

Transmitting DCS settings (TX-DCS) - Menu 29

Function: Transmission DCS settings

Selectable: OFF/105 groups standard negative&positive DCS/Non-standard DCS: D000N–D766I

Default: OFF

When the transceiver is standby, press the **MENU** + **2** **MHZ** + **9** **SOL** keys and the screen will display: 

Press the **MENU** key to access the menu, and after pressing the **▲** / **▼** key to select the DCS you desire, press the **MENU** key to confirm, and press the **EXIT** key to return to standby.

Standard negative & positive DCS: 105 groups; Non-standard DCS: D000N–D766I; OFF: Deactivate.

Repeater speaker switch (RPT-SPK) - Menu 30

Function: Repeater speaker switch settings

Selectable: ON/OFF

Default: OFF

When the transceiver is standby, press the **MENU** + **3** **B/SW** + **0** **SCRAM** keys and the screen will display: 

Press the **MENU** key to access the settings, and after pressing the **▲** / **▼** key to activate (ON) or deactivate (OFF) the speaker, press the **MENU** to confirm, and press the **EXIT** key to return to standby.

Repeater PTT switch (RPT-PTT)- Menu 31

Function: Repeater PTT switch settings

Selectable: ON/OFF

Default: OFF

When the transceiver is standby, press the **MENU** + **3** **B/SW** + **1** **BAND** keys and the screen will display: 

Press the **MENU** key to access the settings, and after pressing the **▲** / **▼** key to activate (ON) or deactivate (OFF) the PTT transmission, press the **MENU** to confirm, and press the **EXIT** key to return to standby.

Function description

Repeater settings (RPT-SET) - Menu 32

Function: Repeater PTT settings

Selectable: RADIO/X-DIRPT/X-TWRPT/RPT-RX/T-W RPT

Default: RADIO

This transceiver has 5 settings available.

1. RADIO: Normal transceiver í s communication mode
2. X-DIRPT: Directional cross-band repeater mode

Note: The master frequency area defines as the cross-band receiver (only for receiving), and the secondary frequency area as the cross-band transmitter (only for transmitting).

Example: The master frequency area A is 150MHz, the secondary frequency area B is 430MHz, the area A receiving signal (Area B cannot receive any signal under X-DIRPT mode), the secondary frequency area B will automatically activate the transmitting work and transmit the 430MHz frequency.

3. X-TWRPT: Two-way cross-band repeater mode

Note: In standby, both master and secondary areas are receiver, whichever area receives an effective carrier wave signal, the other area will be the transmitter and start transmitting. The transmitter and receiver is unfixed under two way cross-band repeater model. The first received area is receiver and relatively the other one is transmitter.

Example: The master frequency area A is 150MHz, the secondary frequency area B is 430MHz, if area A receiving signal in advance then Area B will transmit, if area B receiving signal in advance then Area A will transmit. It means the different frequencies cross-band repeater.

4. RPT-RX: Repeater receiving mode (Repeater receiver, only can be used when combining two transceivers as a repeater)

Note: The master frequency area defines as the repeater receiver (only for receiving)

5. T-W RPT: Two-way cross-band relay mode (Repeater transceiver, only can be used when combining two transceivers as a repeater)







Note: The master frequency area can be defined as transmitter or receiver, it can transmit or receive accordingly.

Special Reminder

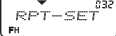

- » In Directional cross-band repeater mode (X-DIRPT), Two-way cross-band repeater mode (X-TWRPT) or Two-way cross-band relay mode (T-W RPT), if the channel or frequency set the reverse frequency, offset frequency, or frequency shift direction, its transmitting frequency would out of the transceiver í s frequency range, then it will not transmit.
- » In cross-band repeater mode, the two channels/frequencies must be two different bands (UV or VU). E.g. the receiving frequency is UHF in Area A, while transmitting frequency must be VHF in Area B, vice verse.
- » Repeater receiver (RPT-RX) and Repeater transceiver (T-W RPT) can be combined as a directional cross-band repeater, while combining two Repeater transceivers (T-W RPT) can be set as a two-way repeater.

Function description

You can select whether the speaker will be on or not, and whether the PTT is available for transmitting during the Cross-band repeater or repeater RX/TX mode via MENU 30 (RPT-SPK) and MENU 31 (RPT-PTT) respectively. But, if activated the RPT-PTT, the signal will be temporarily interrupted if press PTT during these cross-band repeater modes.

When the transceiver is standby, press the  +  +  keys and the screen will display: . Press the  key to enter settings, press the  /  key to select the required type, and press the  key to confirm.

Special Reminder

- » In cross-band repeater mode, the middle of the screen will display . When in repeater transmitting / receiving mode, the screen will display .
- » In order to use the repeating well, there is the Repeating Receipt which is set by MENU46. The repeating receipt timely and effectively reports the working status and increases the efficiency of repeating.
- » The Repeating Hold Timer is used for avoiding to press or release PTT too frequently in order to read out the message. When the mobile receiver was released PTT, the hold time is able for the equipment keeping transmitting for a while during waiting for the response. If there is no efficient QT/DQT detected within the hold time, then the transmitter will be released PTT. The repeating hold timer is setting the hold time for the transmitter to keep transmitting after the QT/QDT receiving signal disappears. This function is programmable by the programming software accordingly.



Scan add (SCAN-ADD) - Menu 33





Function: To set current channel whether participates in scanning when starts channel scanning.

Selectable: ON/OFF

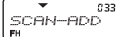
Default: ON

Scan add determines whether a given channel is added to scan. As a result, this function can only be used in channel mode, can only be used with the present channel, and is ineffective in frequency mode.

When the transceiver is in channel mode, press the  +  +  keys and the screen will display: .

Press the  key to access the menu, and after pressing the  /  keys to select the required parameter, press the  key to confirm, and the  key to return to standby.

Scan Add has 2 parameters: ON (add), OFF (cancel).

Note: This function will be prohibited if the transceiver is not working in radio mode.

Automatic power-off (APO-TIME) - Menu 34

Function: If the transceiver undertakes no operations, and does not receive or transmit any signals within a set period of time, the Automatic Power off function will automatically power the transceiver off.

Selectable: OFF/30MIN/60MIN/90MIN/120MIN/150MIN/OFF/30MIN/60MIN/90MIN/120MIN/150MIN

Default: OFF

Function description

When the transceiver is standby, press the **MENU** + **3** (B/SW) + **4** (MEMCH) keys and the screen will display: 

Press the **MENU** key to access the settings menu, and after pressing the **▲** / **▼** keys to select the desired parameters, press the **MENU** key to confirm, and the **EXIT** key to return to standby.

If the transceiver undertakes no operations, and does not receive or transmit any signals within a set period of time, the Automatic Power off function will automatically power the transceiver off.

There are 5 kinds of automatic power off in total: 30 minutes, 60 minutes, 90 minutes, 120 minutes, and 150 minutes. OFF: Turning off the automatic power off function, it is prohibited in repeater or relay mode.

Note: This function will be prohibited if the transceiver is not working in radio mode.

Single-tone pulse frequency (ALERT) - Menu 35

Function: Some of the relay systems used for single-tone pulse transmission need a single-tone pulse signal to activate.

Selectable: 1750Hz/2100Hz/1000Hz/1450Hz

Default: 1750Hz

Special Reminder: When in transmitting mode, you can send the single-tone pulse frequency you've selected by pressing key **【MENU】** on the panel or the **【MAIN】** on the microphone.

Some of the relay systems used for single-tone pulse transmission need a single-tone pulse signal to activate, if a repeater is already active, however, this signal is not needed. The following pulse signal frequencies can be selected: 1750Hz, 2100Hz, 1000Hz, 1450Hz.

When the transceiver is standby, press the **MENU** + **3** (B/SW) + **5** (H/L) keys and the screen will display: 

Press the **MENU** key to access the menu, and after pressing the **▲** / **▼** keys to select the desired parameter, press the **MENU** key to confirm, and the **EXIT** key to return to standby.

Special Reminder

» When in transmitting mode, you can send the single-tone pulse frequency you've selected by pressing key "**1** (BAND)" on the panel or the **MAIN** on the hand microphone.

Compand (COMPAND) - Menu 36

Function: The compand function effectively minimizes noise, and its results are especially evident when transmitting over long distances.

Selectable: ON/OFF

Default: OFF

The compand function effectively minimizes noise, and its results are especially evident when transmitting over long distances.

When the transceiver is standby, press the **MENU** + **3** (B/SW) + **6** (VFO/MR) keys and the screen will display: 

Press the **MENU** key to access the menu, and after pressing the **▲** / **▼** keys to select the desired parameter, press the **MENU** key to confirm, and the **EXIT** key to return to standby.

There are two kinds of compand: ON (activate), OFF (deactivate).

Note: This function will be prohibited if the transceiver is not working in radio mode.

Function description

Overheating detection (FAN-SET) - Menu 37

Function: The transceiver has a built-on temperature detection system that will activate a cooling fan if required.

Selectable: TX / HI-TE / TX / ALWAYS

Default: TX

The transceiver has a built-in temperature detection system that will activate a cooling fan if required.

There are three ways to activate the cooling fan;

TX: In transmitting mode, it will activate the cooling fan.

HI-TE/TX: When the transceiver's temperature reaches a pre-set value or in transmitting mode, it will activate the cooling fan.

ALWAYS: When turn on the transceiver, the fan will always in cooling mode.

When the transceiver is standby, press the **MENU** + **3** **B/SW** + **7** **SET-D** keys and the screen will display:  **FAN-SET** **037**

Press the **MENU** key to access the settings menu, and after pressing **▲** / **▼** keys to select the required parameters, press the **MENU** key to confirm, and the **EXIT** key to return to standby.

Voltage testing (LOW -V) - Menu 38

Function: When the transceiver is installed in a car or another unstable power source (such as a car battery, etc.), please activate this function in order to prevent the transceiver from consuming electricity over an extended period, rendering the equipment unable to supply electricity for regular work.

Note: When the voltage is too low, a voice prompt will sound every 10 seconds, and if Voltage Testing is activate, the transceiver will automatically power off when the voltage is insufficient, If the voltage is found to be too high, transmission will be locked.

Selectable: ON/OFF

Default: OFF

When the transceiver is installed in a car or another unstable power source (such as a car battery, etc), please activate this function in order to prevent the transceiver from consuming electricity over an extended period, rendering the equipment unable to supply electricity for regular work.

When the transceiver is standby, press the **MENU** + **3** **B/SW** + **8** **TOR** keys and the screen will display:  **LOW-V** **038**

Press the **MENU** key to access the settings menu, and after pressing **▲** / **▼** keys to select the required parameters, press the **MENU** key to confirm, and the **EXIT** key to return to standby. ON (activate) or OFF (deactivate)

Special Reminder

- » When the voltage is too low, a voice prompt will sound every 10 seconds, and if Voltage Testing is active, the transceiver will automatically power off when the voltage is insufficient. If the voltage is found to be too high, transmission will be blocked.
- » When you need the transceiver continues to work under the low voltage, please turn on the under-voltage transmission setting via supplied programming software.
- » The transceiver can set the lowest voltage via supplied programming software. The under-voltage threshold value is from 9.5V to 10.5V.

Function description

Voice scrambler (SCRAM) - Menu 39

Function: This function is a kind of special speech handling, activating voice scrambling avoids the user's speech being overheard by users of transceivers who are not using the scrambling function.

Selectable: OFF/OFF/SCRAM 1—10

Default: OFF

This function is a kind of special speech handling, activating voice scrambling avoids the user's speech being overheard by users of transceivers who are not using the scrambling function.

Press the **MENU** + **B/SW** + **SQL** keys, and the screen will display: 

Press the **MENU** key to access the settings menu, and after pressing **▲** / **▼** keys to select the desired setting, press the **MENU** key to confirm, and the **EXIT** key to return to standby.

There are 8 voice scrambling groups (1–8) selectable, and OFF deactivates.

Special Reminder

- » The voice scrambler is optional!
- » This function will be prohibited if the transceiver is not working in radio mode.

Saving scanned CTCSS / DCS (SC-QT) - Menu 40

Function: When scanned CTCSS/DCS, will save scanned CTCSS/DCS. In three types.

Selectable: DECODER/ENCODER/ALL

Default: DECODER

When the transceiver is in CTCSS/DCS scanning, there are 3 saving types to save the detected CTCSS/DCS from the others to your transceiver:

1. Save as your transceivers decoder and encoder (ALL).
2. Save as your transceivers encoder (ENCODER).
3. Save as your transceivers decoder (DECODER).

When the transceiver is standby, press the **MENU** + **4 MEMCH** + **SCRAM** keys and the screen will display: 

Press **▲** or **▼** to select, press the **MENU** to confirm, and press the **EXIT** key to exit.

Special Reminder

- » Saving scanned CTCSS/DCS is ineffective in cross-band repeat or repeater or reception/transmission mode.
- » This function will be prohibited if the transceiver is not working in radio mode.

CTCSS scanning (SC-CTC) - Menu 41

Function: This function scan all the frequencies/channels which with CTCSS setting, in case to confirm if the transmitter transmits the CTCSS mode. When your CTCSS code is not matching with the other member on your group, you can activate this function to confirm the CTCSS mode.

Selectable: 50 Group of CTCSS



Default: CTCSS scanning

Function description

This function scan all the frequencies/channels which with CTCSS setting, in case to confirm if the transmitter transmits the CTCSS code. When your CTCSS code is not matching with the other member on your group, you can activate this function to confirm the CTCSS code.

When the transceiver is in receiving mode, press **MENU** + **4 MEMCH** + **1 BRAND**, the screen displays: , and then press **MENU** to enter the CTCSS scanning.

Special Reminder

- » When the current frequency or channel is not receiving any carrier wave signal, then it cannot activate this CTCSS scanning function.
- » If you want to scan the frequencies or channels counterclockwise, then you can press  /  or rotate the channel knob to change the scanning direction.
- » When scans the CTCSS frequency, it will show on the screen, you can press **MENU** to save. If the scanned CTCSS is unwanted, then you can press  to continue scanning, until scans the one you wanted.

DCS scanning (SC-DCS) - Menu 42

Function: This function scan all the frequencies/channels which with DCS setting, in case to confirm if the transmitter transmits the DCS code. When your DCS code is not matching with the other member of your group, you can activate this function to confirm the DCS code.



Selectable: 105 Group of DCS

Default: DCS Scanning

This function scan all the frequencies/channels which with DCS setting, in case to confirm if the transmitter transmits the DCS code. When your DCS code is not matching with the other member on your group, you can activate this function to confirm the DCS code.

When the transceiver is in receiving mode, press **MENU** + **4 MEMCH** + **2 MHZ**, the screen displays , and then press **MENU** to enter the DCS scanning.

Special Reminder

- » When the current frequency or channel is not receiving any carrier wave signal, then it cannot activate this DCS scanning function.
- » If you want to scan the frequencies or channels counterclockwise, then you can press  /  or rotate the channel knob to change the scanning direction.
- » When scans the DCS frequency, it will show on the screen, you can press **MENU** to save. If the scanned DCS is unwanted, then you can press  to continue scanning, until scans the one you wanted.

Scan group settings (SC-GROUP) - Menu 43

Function: This transceiver can divide the programmed channels into different scan groups and channel scanning can scan the designated channel of the group.

Function description

Selectable: ALL/GROUP 01—10

Default: ALL

The scan group settings are the way that a transceiver can divide the programmed channels into different scan groups. It will scan all channels in this group.

Scan group settings have: ALL channel, as well as 1–10 individual scanning groups.

When the transceiver is standby, press the **MENU** + **4** MEMCH + **3** B/SW keys and the screen will display:



Press **▲** or **▼** to select, press **▶** to confirm, and press **MENU** the **EXIT** key to return.

Special Reminder

- » The Scan group setting is ineffective in Cross-band repeat or repeater reception mode/transmission mode.
- » This function will be prohibited if the transceiver is not working in radio mode.

Remote control (RC-SW) - Menu 44

Function: Via pre-setting dual audio code to control the radio.

Selectable: ON/OFF

Default: OFF

When the transceiver is standby, press the **MENU** + **4** MEMCH + **4** MEMCH keys and the screen display:

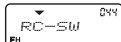

Press the **MENU** key to access the settings menu, and after pressing **▲** / **▼** keys to select the required settings, press the **MENU** key to confirm, and the transceiver will reboot automatically.

There are two settings of remote control setting: ON(activate), OFF(deactivate)

Side key setting (PF1-SET) - Menu 45

Function: During pressing PTT key, press hand microphone to realize definition function.

Selectable: OFF/STUN/KILL/MONI/INSPEC

Default: OFF

Note: This side key is the second button under the PTT key of the supplied DTMF hand microphone, is not on the transceiver's base station.

In standby, press **MENU** + **4** MEMCH + **5** H/L, the screen displays **PF1-SET**. Press **MENU** to enter, press **▲** / **▼** to select the desired setting, then press **MENU** to confirm.

You can define the side key as: OFF (no definition), KILL, STUN, MONI, INSPECTION.

When press PTT to talk, press this side key to activate the above defined setting. The detailed operation instruction, please refer to the remote control setting.

If in standby, press this side key will activate the squelch monitoring.

Repeater receipt tone setting (RPT-TONE) - Menu 46

Function: Repeater tone is the transfer signal received by radio when the repeater is offline.

Selectable: OFF/ON

Default: ON

Function description

In standby, press **MENU** + **4** MEMCH + **6** VFO/MR, the screen displays **RPT TONE**. Press **MENU** to enter, press **▲** / **▼** to select the desired setting, then press **MENU** to confirm and return to standby mode.

ON: Activate the repeater receipt tone function; OFF: Deactivate.

Reset settings (Reset) - Menu 47

Function: Select reset option. Functional Parameter Reset (VFO): Resets all functional settings to factory default values, but channel parameters are not reset. Total Parameter Reset (ALL): resets all of the transceiver's functional settings and channel parameters to factory values.

Selectable: VFO/ALL

Default: VFO

Functional Parameter Reset (VFO): resets all functional settings to factory default values, but channel parameters are not reset.

Total Parameter Reset (ALL): resets all of the transceiver's functional settings and channel parameters to factory values.

When the transceiver is standby, press the **MENU** + **4** MEMCH + **7** SET-D keys and the screen will display: **RESET**.

Press the **MENU** key to access the settings menu, and after pressing the **▲** or **▼** keys to select the desired parameter, press **MENU**, the screen will display: **SURE?**, then press **MENU** and the screen will display: **WAIT...** After the transceiver resets (VFO / ALL), it will restart and return to standby mode.

Hot key A definition - Menu 48

Function: Set the A key function on the display panel

Selectable: OFF/B/SW/MENCH/ H/M/L/VFO/MR/SET-D/TDR/SQL/SCAN/FM-RADIO/SC-CTC/SC-DCS

Default: H/M/L

Hot key B definition - Menu 49

Function: Set the B key function on the display panel

Selectable: OFF/B/SW/MENCH/H/M/L/VFO/MR/SET-D/TDR/SQL/SCAN/FM-RADIO/SC-CTC/SC-DCS

Default: VFO/MR

Hot key C definition - Menu 50

Function: Set the C key function on the display panel

Selectable: OFF/B/SW/MENCH/H/M/L/VFO/MR/SET-D/TDR/SQL/SCAN/FM-RADIO/SC-CTC/SC-DCS

Default: TDR

ABR - Menu 51

Function: Time of the backlight settings

Selectable: OFF/ALWAYS/1-20S

Default: ALWAYS

Function description

FM radio function (FM-RADIO) - Menu 52

Function: Through this menu enter FM Radio function

Selectable: ON/OFF

Default: OFF

Special tips: When enter FM Radio, Press 【 MENU 】 on display and hand microphone will start FM Radio scanning function in when radio is standby.

Press keyboard lock key will activate radio storage function, and press keyboard lock key again will start radio channel menu, and you can press up and down key to choose radio channel, press 【 MENU 】 to confirm.

You can enter the FM radio by using this function.

When the transceiver is standby, press the **MENU** + **5** H/L + **2** MHZ keys and the screen will display: 

Press the **▲** or **▼** keys to select, when select ON, press the **MENU** key to enter FM radio, when select OFF, press **MENU** to return to standby mode.

Special Reminder

- » The FM-Radio function is ineffective in Cross-band repeat or repeater reception mode/transmission mode.
- » This function will be prohibited if the transceiver is not working in radio mode.
- » This function can only be set on Area A.

AM frequency auto-recognize switch (AUT.AM) - Menu 53

Function: Activate this function, the transceiver will automatically recognize the AM receiving frequency.

Selectable: ON/OFF

Default: ON

Note: This transceiver will automatically recognize the AM receiving frequency.

In standby, press **MENU** + **5** H/L + **3** B/SW, the screen displays . Press **MENU** to enter, press **▲** / **▼** to select the desired setting, then press **MENU** to confirm, and press **EXIT** to return to standby.

ON: Activate this function, it will automatically recognize 108.000MHz – 135.995MHz as the AM receiving mode; OFF: Deactivate.

Note: This function can only be set on Area A.

AM setting (AM-SW) --- Menu 54

Note: It will set the transceiver in AM receiving mode.

In standby, press **MENU** + **5** H/L + **4** MEMCH, the screen displays . Press **MENU** to enter, press **▲** / **▼** to select the desired setting, then press **MENU** to confirm, and press **EXIT** to return to standby.

ON: Activate; OFF: Deactivate.

Note: This function can only be set on Area A. Each band can set the AM receiving mode respectively.

Optional accessories

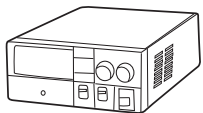

Switching Power Supply (30A)

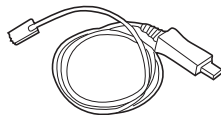

USB Programming Cable



Mobile Speaker / Mic



Omni-antenna

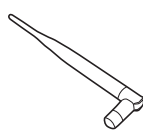

Omni-antenna

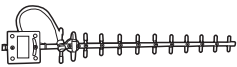

Directional-Antenna



Clamps Install Mount

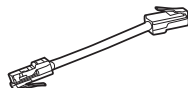

Connection Cable

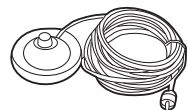

Strong Magnetic Mount

Troubleshooting

Before assuming your transceiver is broken, please check your transceiver according to the following table; if the problem persists, you can reset the transceiver, which sometimes resolves problems with settings.

Fault	Solution
Reception prompt remains but speaker is silent	<ul style="list-style-type: none"> » Check that the volume knob has been set to maximum. » Please reset sub-audio settings to check whether different channels from other group members have been set. » Check whether squelch settings are correct.
Keypad is unresponsive	<ul style="list-style-type: none"> » Check whether keypad has been locked. » Check whether other keys have been pressed.
Other voices (not from group members) appear in the channel.	<ul style="list-style-type: none"> » Please change the CTCSS / DCS code.
Receive regular voice pause (About 3 second intervals)	<ul style="list-style-type: none"> » Please see if the "PRICH-SW" (Priority scanning switch) is turned on.
Can not enter scanning mode	<ul style="list-style-type: none"> » Please see if the scan group channel, Scan Add function is turned on.
Transceiver automated activation/deactivation switch	<ul style="list-style-type: none"> » Please make sure all used power sources are under 11.5V, or if the "APO" switch is on.
When pressing the transceiver PTT key to transmit, there is no output power and no reception	<ul style="list-style-type: none"> » See if it has been stunned or killed.
Cannot set up the cross-band repeater	<ul style="list-style-type: none"> » Please make sure A/B area is on the cross-band repeaters operating frequency.
Cannot transmit in repeat mode	<ul style="list-style-type: none"> » Please check to see if the receivers squelch and CTCSS / DCS settings are correct.

Announcement

We endeavor to achieve the accuracy and completeness of this manual, but it is still not perfect for any possible omissions or printing errors. All the above is subject to be updated without prior notice.

Edition: 202009-V2