



X-30A

X-50N/X-50NA

X-200N

X-300N



PASSION-RADIO.FR
Analogique - Numérique - SDR

FRP Outershell
Direct joint structure (X-200N / X-300N)

Description

1. X-50N/X-50NA employs high performance C-Load structures.
2. Newly developed Liner Phase Shifter technology being employed on X-200N/X-300N permits the antenna to achieve high performance, high power rating, low vswr, and broader band coverage on both 2m and 70cm bands.

Each antenna has the following structure:

- | | |
|-------------------|-------------------------------------------------------------|
| X-30A | 1/2 wave element(2m),
5/8 wave two element(70cm) |
| X-50N / NA | 6/8 wave C-Load(2m),
5/8 wave three element C-Load(70cm) |
| X-200N | 5/8 wave two element(2m),
5/8 wave four element(70cm) |
| X-300N | 5/8 wave two element(2m),
5/8 wave five element(70cm) |
3. Newly developed direct element joint structure with two interconnected FRP outershells being employed in X-200N/X-300N enables the antenna to maintain the same strength as one with one piece structure by its overlapping FRP outershells. Perfect waterproof being achieved by ring gasket enables the antenna to maintain their performance without awaring rainy weather. And the antenna can be easily assembled or disassembled when it is required, by tightening or loosening the joint bracket accordingly.
 4. Professional quality maximum wind resistance is achieved by their rugged structure. And superior waterproof structure avoids awaring for unstable vswr being caused by climatic effects. Rust and corrosion free structure, again, permits the antennas to be installed at seaside or contaminated air environment without any precautions.
 5. Both of the bands, 2m and 70cm, can be operated simultaneously by using optional antenna duplexer.
 - DIAMOND's genuine duplexers are recommended.
 6. DC ground structure, which escapes high voltage caused by thunder lightning to the ground, protects your radio equipments.

Adjustment

All X series antennas are completely adjustment free. If vswr of an antenna is extraordinary high, see if each connecting part is well contacted. It is most likely due to bad contact in coaxial cable and/or connector connection, or soldering problem. Be sure to use 50ohms coaxial cable to feed the antenna.

Assembling the X-30A / X-50N / X-50NA

1. Attach three radial elements to the feedpoint section, which is one piece structure with FRP element outer shell,

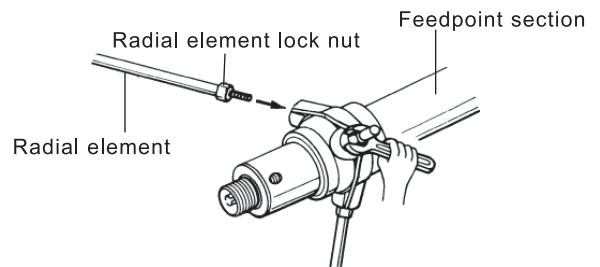

2. Fix two mast brackets to support pipe, Then connect coaxial cable to the feedpoint section through support pipe. Fix support pipe to the feedpoint section with a lock screw by aligning the holes at the bottom of the section and top of the pipe,
3. Attach assembled antenna to a mast by taking whole balance into account and fix it firmly as shown in Fig. 1.

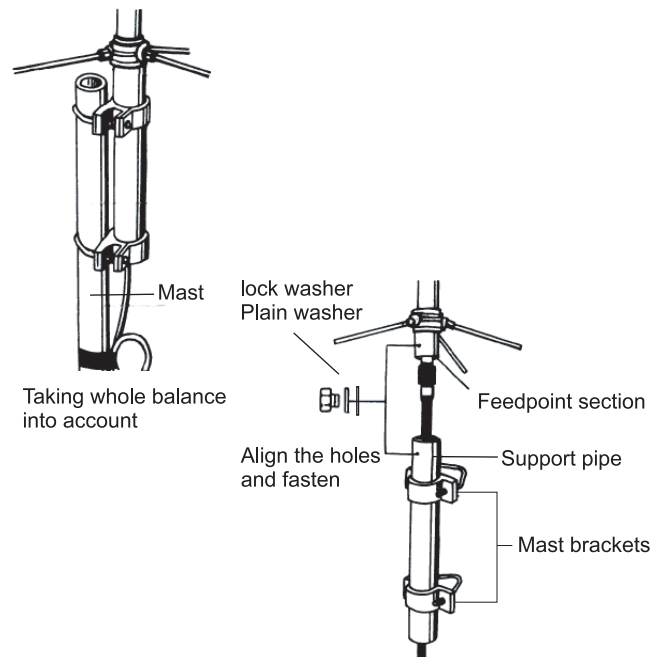
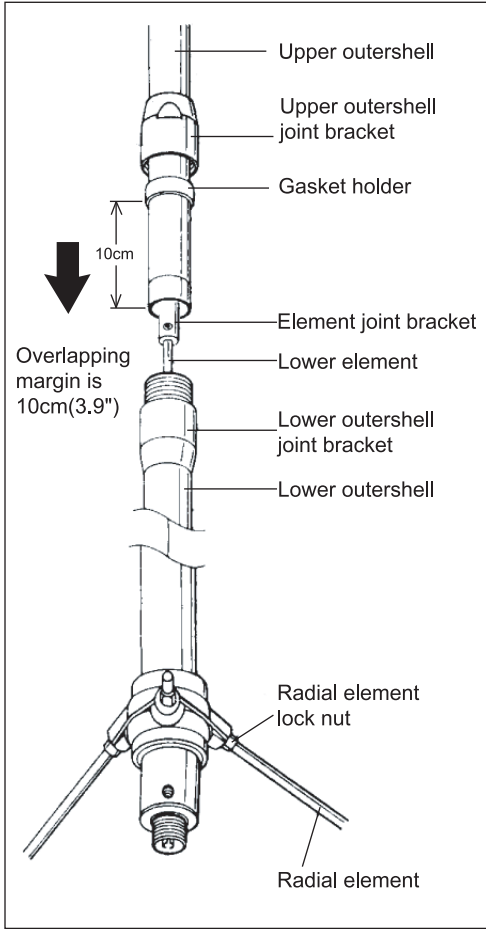

Fig.1



Assembling the X-200N/X-300N



1. Connect upper and lower elements.

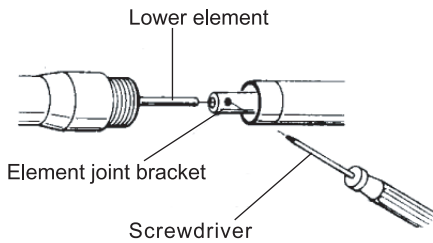

2. Put lower element into element joint bracket thoroughly and fix it.

3. After fixing the element into the joint bracket, fix upper and lower outershells with outershell joint bracket as shown in Fig.2.

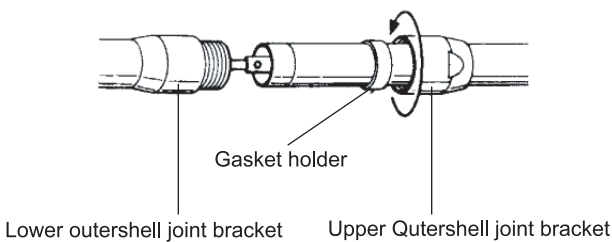
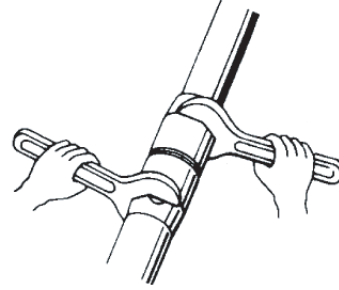

Fig.2

4. Fasten upper outershell joint bracket with a wrench by holding lower outershell joint bracket firmly with a wrench at the same time. For perfect waterproof, fasten the brackets until there is no gap between them.



5. Attach three radial elements as shown in Fig.3.

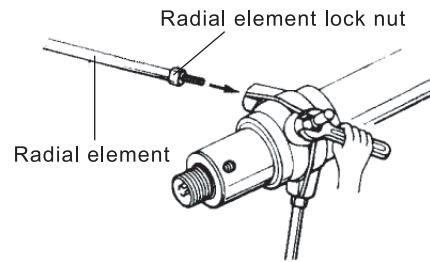
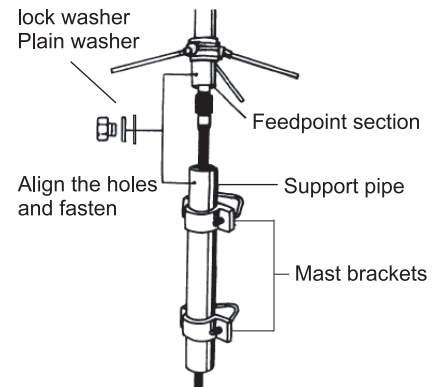
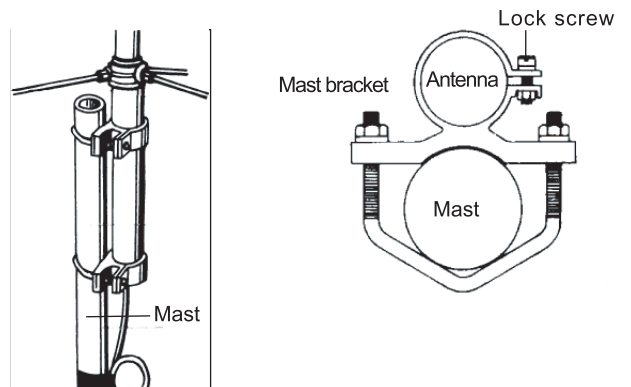

Fig.3

6. Attach two mast brackets to the support pipe. Then connect a coaxial cable to the feedpoint section through the support pipe. By aligning the holes at the bottom of the feedpoint section and upper part of the pipe, fasten the pipe with a lock screw.



7. Attach assembled antenna on mast by whole balance into account.



Specifications

Model	X-50N	X-200N	X-300N	X-30A	X-50NA
Frequency	144-146MHz 430-440MHz			146-148MHz 435-450MHz	
Gain 2m	4.5dB	6.0dB	6.5dB	3.0dB	4.5dB
Gain 70cm	7.2dB	8.0dB	9.0dB	5.5dB	7.2dB
Max.power rating	200W			150W	200W
Max. wind resistance	60m/sec 135MPH	50m/sec 112.5MPH		60m/sec 135MPH	
Impedance	50ohms				
V.SWR	less than 1.5:1(see charts)				
Mast diameter accepted	30-62mm(1 3/16" to 2 7/16")				
Length	1.7m(67")	2.5m(98.4")	2.9m(114.2")	1.3m(51.2")	1.7m(67")
Weight	0.9kg 2.3lbs.	1.2kg 2.6lbs.	1.5kg 3.3lbs.	0.8kg 1.8lbs.	0.9kg 2.3lbs.
Connector	N			UHF	N
Type	6/8 wave C-Load(2m) 5/8 wave three element C-Load(70cm)	5/8 wave two element(2m) 5/8 wave four element(70cm)	5/8 wave two element(2m) 5/8 wave five element(70cm)	1/2 wave element(2m) 5/8 wave two element(70cm)	6/8 wave C-Load(2m) 5/8 wave three element C-Load(70cm)

Note

Though all X series antennas employ DC ground structure, circuit across center conductor section and ground section of the connector is open(not conducted) if it is measured by a volt-ohm meter. If it is closed(conducted), check to see coaxial cable and/or connector thoroughly.

Be sure to install the antenna vertically. Full performance of the antenna can not be guaranteed if the antenna is not installed vertically.

Since N connector is relatively complicated compared with conventional UHF type connector, utmost care has to be taken to handle connector to coaxial cable connection.

It is recommended to practice test transmission for adjustment as short and least power as possible.

Warning

Do not touch or come close to the antenna during transmission.

Do not install the antenna where is easily reachable by the children.

V.SWR chart (X-50N)

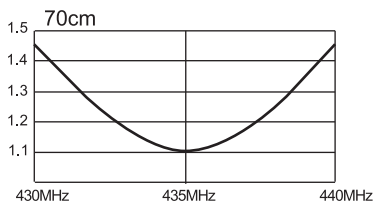
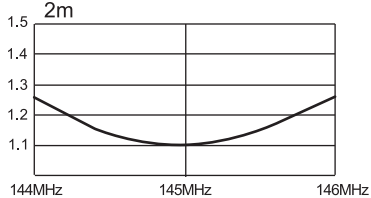

V.SWR chart (X-200N)

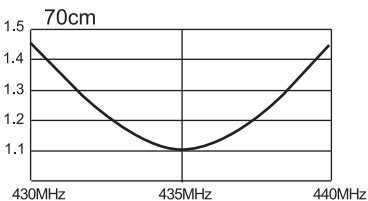
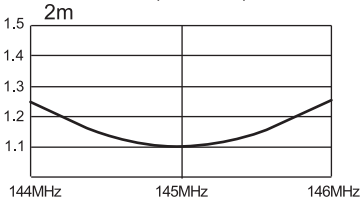

V.SWR chart (X-300N)

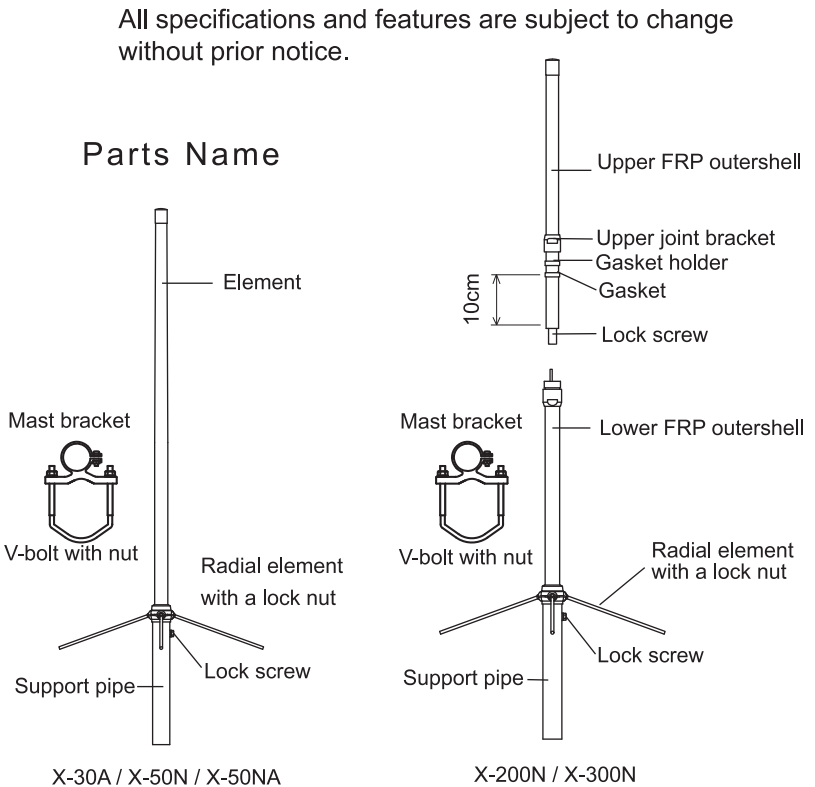
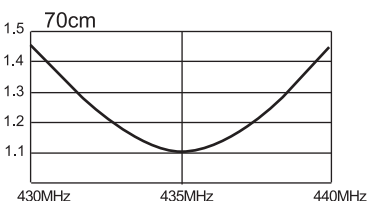
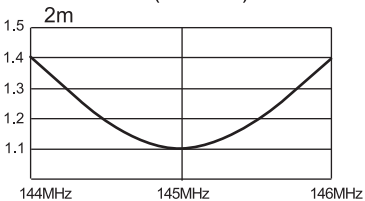

V.SWR chart (X-30A)

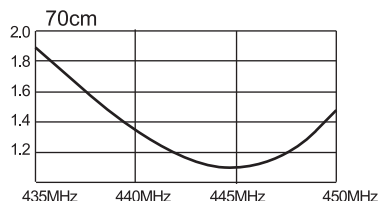
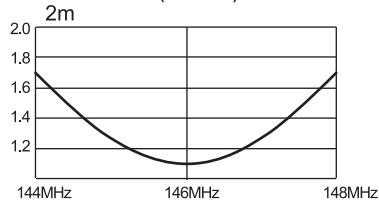

V.SWR chart (X-50NA)

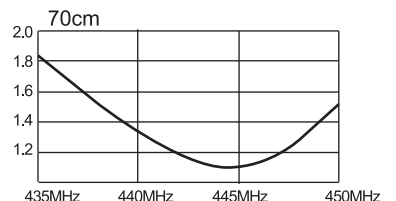
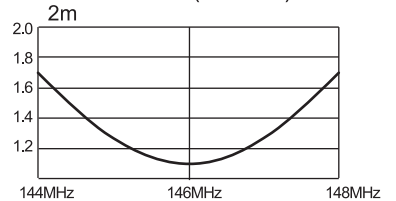

FOR YOUR SAFETY

Read the following safety precautions before start assembling the antenna.

- Assemble the antenna on the ground or wide and flat place such as on balcony before installation.
- Do not assemble or install the antenna on a place where you can not have enough distance from any electric power lines.
- Do not install the antenna on a rainy or windy day.
- Do not attempt to install the antenna only by yourself. Installing the antenna alone on the roof may lead you dangerous accident. Always ask your friends for help installing the antenna.
- Do not use iron or aluminum ladder at a reachable distance from any electric power lines.
- Do not install the antenna on a mast which is not grounded properly.
- Do not have your family members or friends touch or come close to the antenna, unless they have realized its potential danger.

TO AVOID FATAL ACCIDENT

- Do not attempt to sustain the antenna, or any part of support structure if it begins to fall down. Let it fall by itself.
- Do not attempt to remove or restore the antenna or any part of support structure if it touches a electric power line by chance. Let it be as it is, do not touch it, and call your local electric power company immediately.

IN CASE OF AN ACCIDENT

- Do not touch a person or an animal who is or seems to be in contact with the antenna or any support structure which is fallen on a live electric power line. Touching one may lead you to be electrocuted.
- Do not attempt to separate a person or an animal who is or seems to be in contact with the antenna or any support structure which is fallen on a live electric power line by yourself. Call or have someone call a police officer, ambulance, doctor immediately.

ANTENNA INSTALLATION PRECAUTIONS

To determine antenna installation location, there are several factors to be taken into account. First thing is antenna propagation direction to specific target stations. As to whether there is any obstacles such as tall buildings on the line of sight. Next is specific installation location. As to whether specific location is adequate in terms of antenna support and surrounding safety.

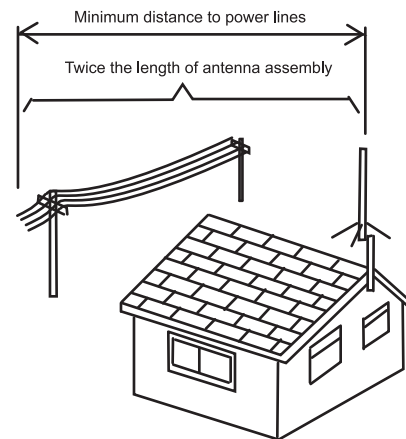

- Do not attempt to install the antenna by yourself if you do not have any experience in installing base station antenna. Ask your experienced friends or professional for help.
- Do not attempt to install the antenna at a location where does not have enough distance from nearby electric power lines. it is advised to install the antenna at least twice of total antenna height from nearby electric power lines.
- Do not install the antenna on any type of tower, pole or telescopic mast which exceeds 30 feet high, if you do not have enough experience in installing the antenna on that kind of location. Ask your experienced friends or professional for help.
- Do not use more than 1/10' section if you install the antenna on iron plumber's pipe. Attach guy wire if multiple pipes are used to install the antenna.



2005 / 04

DIAMOND ANTENNA CORPORATION

Miyata Building, No,15-1, 1-chome, Sugamo Toshima-ku, Tokyo 170-0002, Japan Phone:(03) 3947-1411 Fax:(03) 3944-2981
<http://www.diamond-ant.co.jp>