

NanoVNA-Fairy NanoVNA-F

Handheld Vector Network Analyzer Incomplete Manual

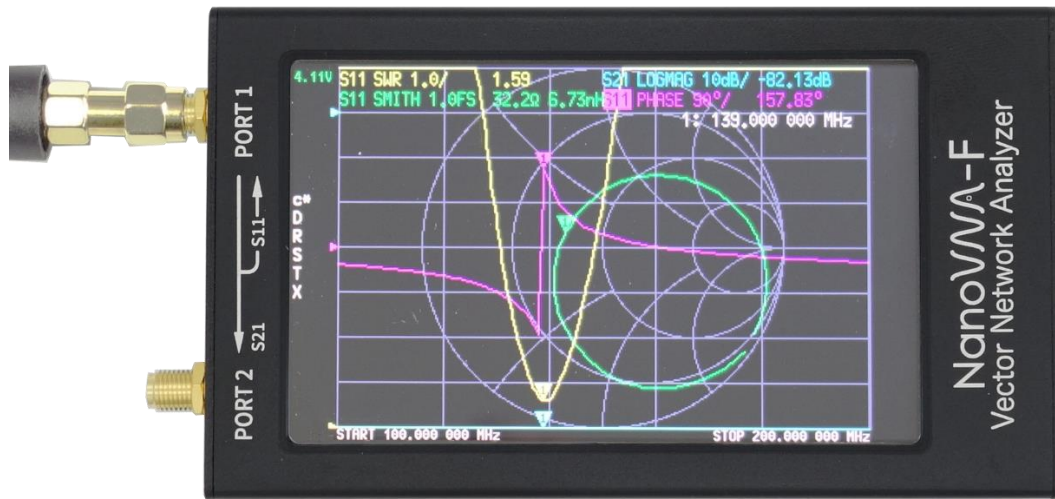

BH5HNU & June
deepelec.com
2020-01-08

Table of Contents

Overview	3
Characteristic.....	4
Menu Structure	5
Basic operations	6
Calibration and Normalization	8
Charging and battery instructions.....	11
Packaging details	13
FAQs.....	14
1. About after sales service ?.....	14
2. How to distinguish the authenticity of NanoVNA-F ?	14
3. What can I do if I get a machine without a built-in battery ?	14
4. How to perform a vector network analyzer calibration ?.....	15
5. When to perform a vector network analyzer calibration ?	15
6. How do I calibrate the touch screen ?.....	15
7. How do I upgrade the firmware ?.....	16
8. How to add call sign display ?.....	18
9. How to use PC software and how to install drivers ?	19

Overview

NanoVNA-F "Handheld Vector Network Analyzer" is a product based on the Open Source Project of NanoVNA (<https://ttrf.tk/kit/nanovna>).

We designed the NanoVNA-F hardware, which is based on the STM32F103 Cortex-M3 processor and has a larger and brighter 4.3-inch high resolution IPS display, a large-capacity battery, a metal body, a full set of accessories, and more.

At the same time, we have transplanted the open source software of edy555 to FreeRTOS system. The current open source address of this project is: <https://github.com/flyoob/NanoVNA-F>. Every enthusiast can view and learn to compile the firmware.



NanoVNA-F™

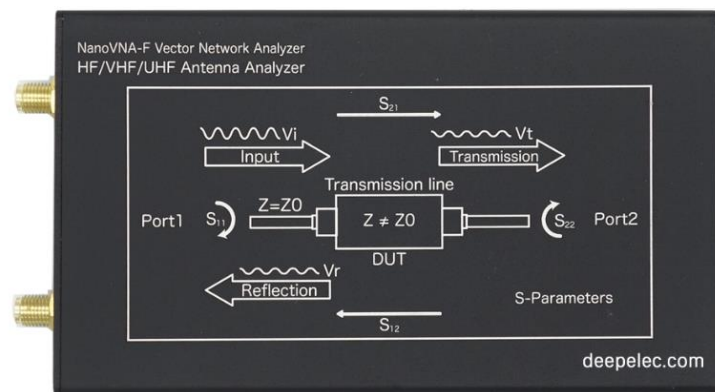

Characteristic

Description	Specification	Supplemental Information
Frequency range	50 kHz to 1 GHz	measurable frequency up to 1.5 GHz, accurate measurement up to 1.35 GHz
Frequency reference		
Temperature Stability (-30 ~ +85 °C)	± 0.5 ppm ~ ± 2.0 ppm	
Aging (at 25 °C)	± 1 ppm / year Max.	
Data points	101	Number of calibration points Number of scanning points
Sweep cycle	About 1.9 s	Turn on the built-in filter
Display Trace	4	
Marker	4	
Parameter storage	5	
Measurements	S11, S21 magnitude and phase	
	S22, S12 magnitude and phase	need reverse DUT connection
Formats	Log magnitude, linear magnitude, VSWR, phase, Smith chart, polar, group delay, real, imaginary, resistance, reactance	
System dynamic range		after calibration and normalization
50 kHz ~ 300 MHz	60 dB	S11
300 MHz ~ 600 MHz	50 dB	
600 MHz ~ 1000 MHz	40 dB	
50 kHz ~ 300 MHz	70 dB	S21
300 MHz ~ 600 MHz	70 dB	
600 MHz ~ 1000 MHz	60 dB	
PORT1 output power		
50kHz to 300MHz	-13 dBm	maximum -9 dBm
PORT2 damage level		
50kHz to 300MHz	+20 dBm	
Display	4.3 inch IPS LCD	800*480 dots
Communication & Charging interface	USB Type-C	Communication mode: CDC (serial)
Power consumption	Discharging: 5V 200mA; Charging: 5V Max 2A	LCD Backlight 75%, adjustable;
Output capacity	5V/1A	USB Type-A
Battery	4000mAh	Discharge cut-off voltage 3.0V
Size	14CM * 7.5CM * 2CM	length, width and height

Menu Structure

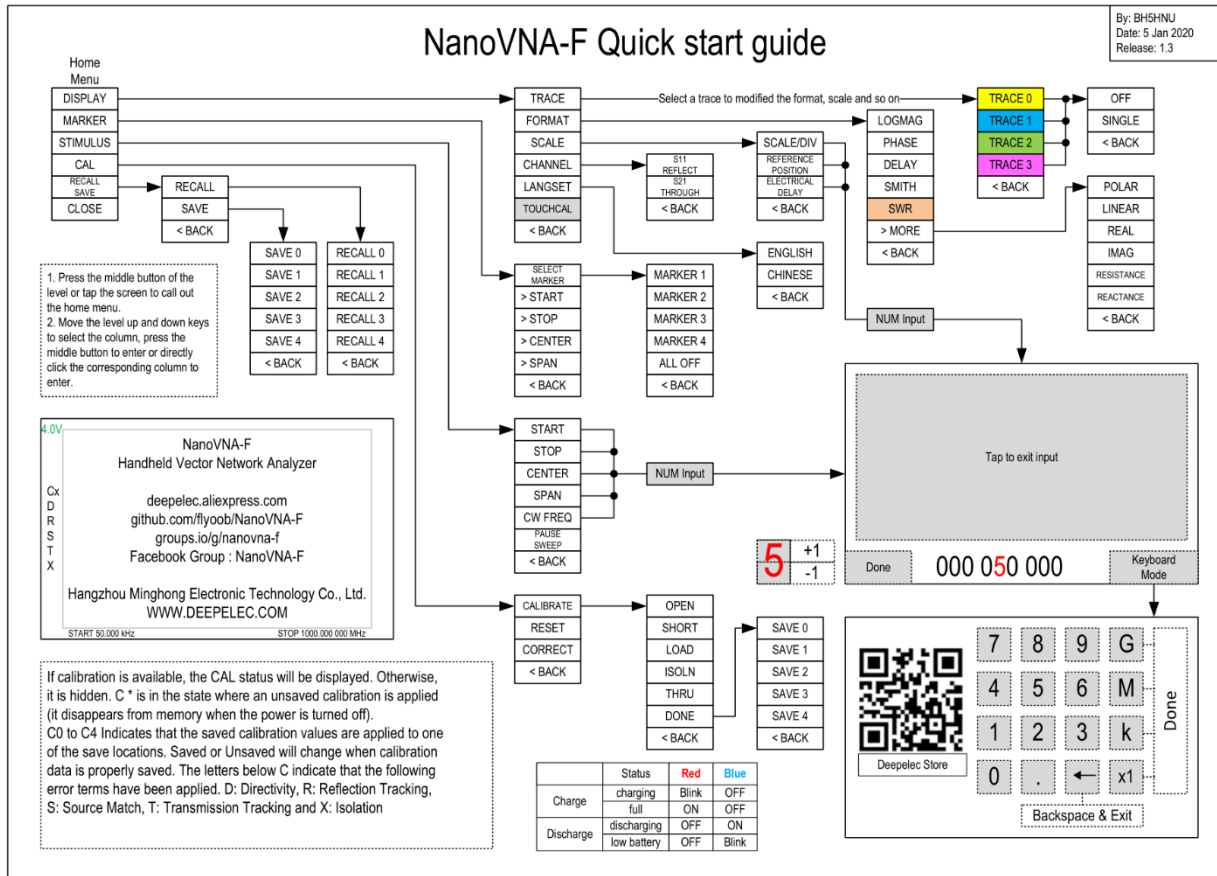

Each NanoVNA-F machine comes with this paper quick start guide (menu structure chart), which is convenient for users to learn and use the machine as soon as they get it.

The guide was inspired by AE5CZ, and we would like to thank it.

Due to the firmware update, the Quick Start Guide is constantly being improved and optimized, please click the link below to get the latest PDF version.

Click to [download](#) the latest version.

Basic operations

Start a measurement:

1. Set the frequency range (STIMULUS→START/STOP or CENTER/SPAN)
2. Calibration (According to actual needs, refer to the next chapter)
3. Select display format and channel (DISPLAY→FORMAT/CHANNEL)
4. Save the parameters for the next measurement. (SAVE→0/1/2/3/4)

You can change the display format and channel selection at any time. In the normal test mode, tap the right area of the screen or press the multifunctional switch to call up the menu. Tap the screen or turn the multifunctional switch to select a menu item.

Select the display trace and display format/channel:

The menu DISPLAY → TRACE item can choose to open (activate) or close the corresponding display curve. When the background color of the curve name is consistent with the curve color, it indicates that the curve is active. The items FORMAT, SCALE, and CHANNEL are only valid for this curve. DISPLAY→SCALE can adjust the scale, DISPLAY→CHANNEL can select the measured port.

Setting the frequency range:

The frequency range of a channel can be expressed by three groups of parameters:

Start Frequency, Center Frequency and Stop Frequency. If any of the parameters change, the others will be adjusted automatically in order to ensure the coupling relationship among them.

$$f_{center} = (f_{start} + f_{stop}) / 2$$

$$f_{span} = f_{stop} - f_{start}$$

Where f_{span} is the SPAN.

Usage 1:

Set the center frequency point of the current screen through the STIMULUS→CENTER of the menu, and display the values of the center frequency and sweep span, respectively, to the left and right of the bottom of the grid.

In the lower-right corner of the pop-up Settings value screen, click to eject the soft keyboard and enter the frequency value via the soft keyboard.

Please pay attention to the following points:

The start and stop frequencies will vary with changes to the center frequency when the span is constant.

In Zero Span, the start frequency, stop frequency and center frequency are always set to the same value.

Now, you can use PORT1 as a signal source for a fixed output amplitude, but it is important to note that this machine uses the clock signal generator Si5351 as the signal source, the output signal is square wave, contains a larger odd harmonic.

Usage 2:

Set the frequency range through the STIMULUS→SPAN of the menu, display the center frequency and sweep span values on the left and right sides of the grid, and click on the lower right corner of the pop-up settings value screen to eject the soft keyboard and enter the frequency values through the soft keyboard.

Please pay attention to the following points:

The start and stop frequency vary with the span when the center frequency is constant.

When the span is set to the maximum, the analyzer enters full span mode.

In Zero Span, the start frequency, stop frequency and center frequency are always set to the same value.

Usage 3:

Set the start frequency through the STIMULUS→START of the menu and display the start frequency and stop frequency values on the left and right sides of the grid, respectively. Click on the bottom right corner of the pop-up settings screen to eject the soft keyboard and enter the frequency value through the soft keyboard.

Please pay attention to the following points:

The span and center frequency vary with the start frequency when the span does not reach the minimum (The parameters vary with the span, please refer to "Span");

In Zero Span, the start frequency, stop frequency and center frequency are always the same value.

Set the stop frequency through the STIMULUS→STOP of the menu, and display the start frequency and stop frequency values on the left and right sides of the grid, respectively, in the lower right corner of the pop-up Settings screen, click to eject the soft keyboard and enter the frequency value through the soft keyboard. Please pay attention to the following points: The span and center frequency vary with the stop frequency. The change of the span will affect other system parameters. For more details, please refer to "Span".

In Zero Span, the start frequency, stop frequency and center frequency are always the same value.

For more test examples, please visit [Deepelec Store](#).

Calibration and Normalization

The VNA Master is a field portable unit operating in the rigors of the test environment. In order to ensure measurement accuracy, RF calibration (SOLT) must be performed prior to making a measurement in the field. Calibrating with the specified mechanical calibration requires three calibration parts: open, short, and match(load) and one RG316 RF cable. Calibration data is saved as user calibration data. It can be saved to status 0/1/2/3/4, which will be automatically loaded at the next boot and can be also be loaded via the RECALL menu.

The figure below shows the OPEN, SHORT, and LOAD calibration components that are standard with the NanoVNA-F.

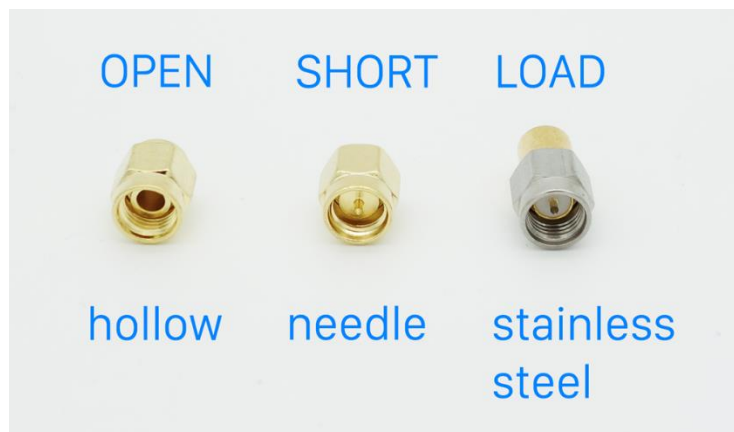

Brief summary of NanoVNA-F calibration steps:

- 1) Open CAL menu and press RESET
- 2) Open CALIBRATE menu
- 3) Connect SMA Open to PORT1 wait more than 3 seconds (wait for the screen to stabilize) and press OPEN
- 4) Connect SMA Short to PORT1 wait more than 3 seconds (wait for the screen to stabilize) and press SHORT
- 5) Connect SMA Load to PORT1 wait more than 3 seconds (wait for the screen to stabilize) and press LOAD
- 6) Connect SMA Load to PORT1, connect second Load to PORT2, wait more than 3 seconds (wait for the screen to stabilize) and press ISOLN

Note: if you don't have second Load, just leave PORT2 open.

- 7) Connect RF cable from PORT1 to PORT2 wait more than 3 seconds (wait for the screen to stabilize) and press THRU
- 8) Press DONE, save to 0/1/2/3/4 one of them.

Note: If there is already saved calibration data, first press “Reset” to clear the calibration data and then calibrate!

If you make a mistake, start again with RESET!

Once the calibration is complete, the three calibrators can be connected to PORT1 again, and the correct calibration should be based on the S11 SMITH chart, which should be:

When connected to OPEN, the curves should be concentrated on the far right of the S11 SMITH chart;

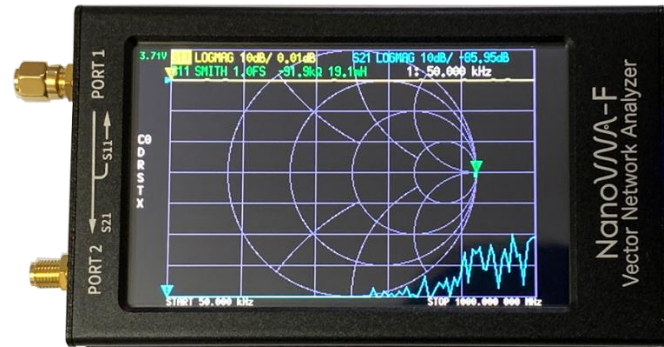

When connected to SHORT, the curves should be concentrated on the left most side of the S11 SMITH chart;

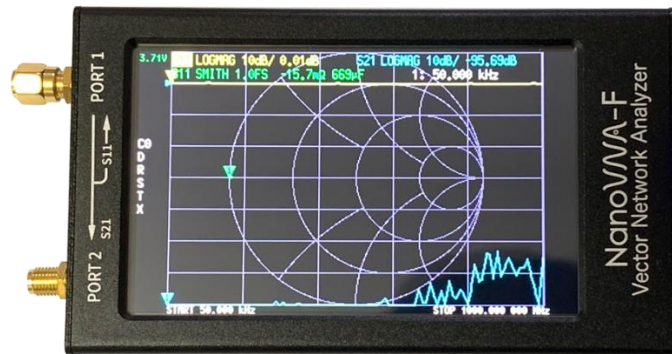

When connecting LOAD, the curves should all be concentrated in the middle of the S11 SMITH chart;

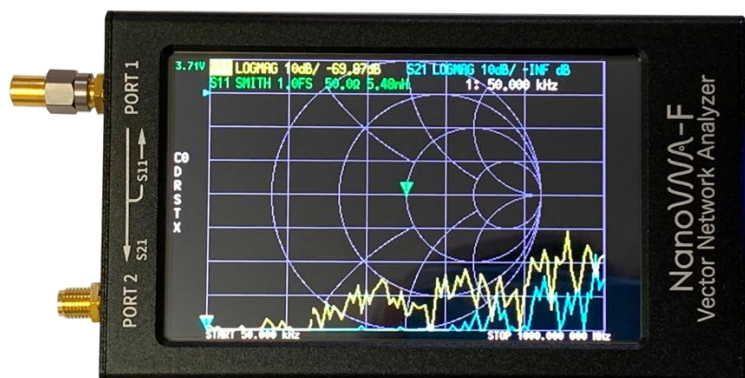

Using RF cables to connect Port 0 and port 1, view S21 curve errors should not exceed 0.1dB.

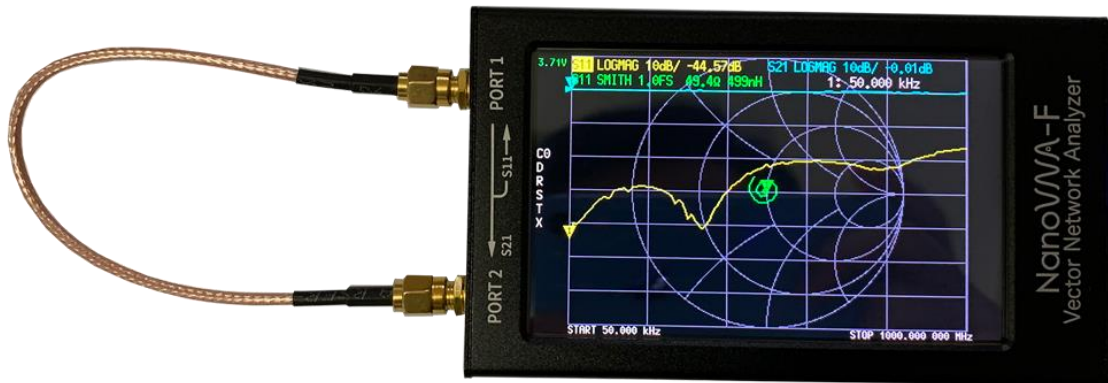

If calibration data abnormalities are found, they should be re-calibrated.

If calibration is available, the CAL status will be displayed. Otherwise, it is hidden.

C* is in the state where an unsaved calibration is applied (it disappears from memory when the power is turned off). C0 to C4 Indicates that the saved calibration values are applied to one of the save locations.

Saved or Unsaved will change when calibration data is properly saved.

The letters below C indicate that the following error terms have been applied.

D: Directivity, R: Reflection Tracking, S: Source Match, T: Transmission Tracking and X: Isolation

The instrument has been fully frequency-calibrated(50kHz~1GHz) before shipment and Store the data in parameter 0, and the boot will load the status 0 data directly.

If you change the measurement conditions, such as adding a adapter and modifying the frequency range, you may need to recalibrate and store the parameters in 0-4. All parameters can be called up by the "recall" function.

Charging and battery instructions



NanoVNA-F charging port is a standard USB Type-C interface. You can use the USB interface to connect to computer communications or connect standard 5V charger charging.(charger with an output current capacity of at least 1A). After turning off the power, the blue light stays on for about 40 seconds, and then goes out.

At the same time, we also designed a USB Type-A 5V power output port for customers, using internal batteries to boost to 5V. In an emergency, users can use NanoVNA-F as a mobile power supply.

When NanoVNA-F is charging and discharging, the status of the indicator is as follows:

	Status	Red	Blue
Charge	Charging	Blink	OFF
	Full	ON	OFF
Discharge	Discharging	OFF	ON
	Low battery	OFF	Blink

About NanoVNA-F without built-in battery:

Our official store supports shipping NanoVNA-F with a built-in battery version to most parts of the world. If you bought a machine without a built-in battery in another store, you may need to install a battery for it. Each NanoVNA-F machine we produce without a built-in battery is equipped with an acrylic board for fixing the battery by default. As shown below, You can use a cable tie or double-sided tape to secure the battery.

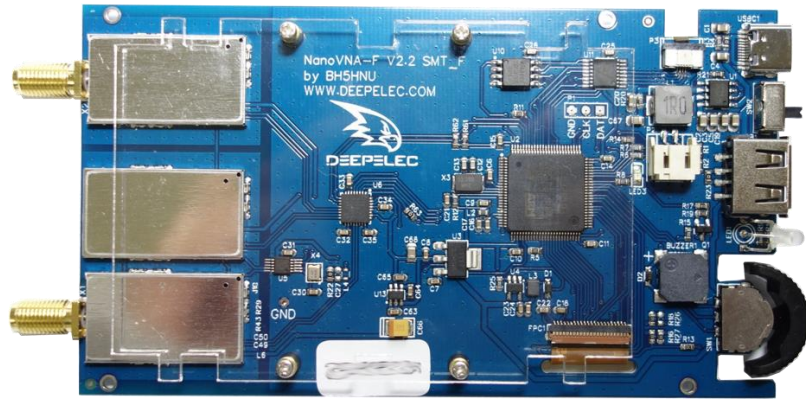

You can use a common polymer lithium-ion battery as the battery for your machine, which size limit $< L(90\text{mm}) * W(54\text{mm}) * H(5.6\text{mm})$.

You can solder the battery directly to the PCB. But the recommended method is to add a terminal, the type of the power interface is PH2.0, the connector on the battery side needs to match it, and the cable length is about 4CM.



Packaging details

From January 6, 2020, the following new boxes and complete accessories are provided.



- NanoVNA-F host 4.3 inch (with Shielding protective film) x 1
- USB Type-C data cable x1
- 20cm SMA male to male RG316 RF cable x2
- SMA male calibration kit - OPEN x1
- SMA male calibration kit - SHORT x1
- SMA male calibration kit - LOAD x1
- SMA-JJ male to male connector x1
- SMA-KK female to female connector x1
- SMA-JKW male to female right angle connector x1

Please visit [Deepelec Store](#) for more information.

FAQs

1. About after sales service ?

After purchasing a genuine machine, if you have any problems during use, you can contact us in the following ways.

Technical Support: support@deepelec.com

Online discussion group: <https://groups.io/g/nanovna-f>

Facebook NanoVNA-F: <https://www.facebook.com/groups/409434709714445>

2. How to distinguish the authenticity of NanoVNA-F ?

The appearance of the latest version of NanoVNA we are currently selling is shown below. You can also see more appearance pictures on the deepelec.com website. <http://deepelec.com/2020/01/11/about-nanovna-f-product-packaging>

Each NanoVNA-F we produce has a unique serial number on the side of the fuselage, which is the only proof of after-sales service and warranty.



The NanoVNA-F text with artistic fonts is a trademark / Logo (under registration) registered by Deepelec in China. From November 15, 2019, we only produce NanoVNA-F with this trademark / Logo, Please check carefully before buying. If the silk screen of the machine you received is incomplete or the logo is inconsistent with the picture below, it is most likely a counterfeit.

NanoVNA-F

3. What can I do if I get a machine without a built-in battery ?

Please refer to the reference section: Charging and battery instructions

4. How to perform a vector network analyzer calibration ?

Please refer to the reference section: Calibration and Normalization

5. When to perform a vector network analyzer calibration ?

(1) Do I have to calibrate each time I measure a new item?

A: This is not necessarily required. Try to store the state of each calibration in the VNA. The name is preferably the calibration state, such as frequency range, input excitation power, etc. If there is a new test item, but its test conditions are similar to the existing state, and after the load state, check the calibration state is good, you can use the previous calibration state without re-calibration.

The advantage of saving and recalling the calibration state is that the calibration kit also has a service life. Multiple calibrations will cause the calibration part to contact the port multiple times, which may contaminate the calibration part and cause the characteristics of the calibration part to change, affecting the next calibration. Try to form the following habit: add a dust cover when the PORT of the network analyzer is not in use; label the test cables so that each port of the VNA is connected to a certain cable as much as possible; when the test cables are not in use, you also need to add a protective cover. Dust jacket; try not to use dirty test cables.

(2) How long can one calibration take?

A: Because the vector network analyzer is calibrated in a specific environment, over time, environmental factors and the situation at the time of calibration become inconsistent, resulting in invalid calibration results. Environmental factors include temperature, humidity, and cable bending, which are difficult to quantify. Therefore, after calibration once, until you feel that the calibration effect does not meet the test requirements, then perform the calibration again.

6. How do I calibrate the touch screen ?

(1) Enter menu DISPLAY-TOUCHCAL

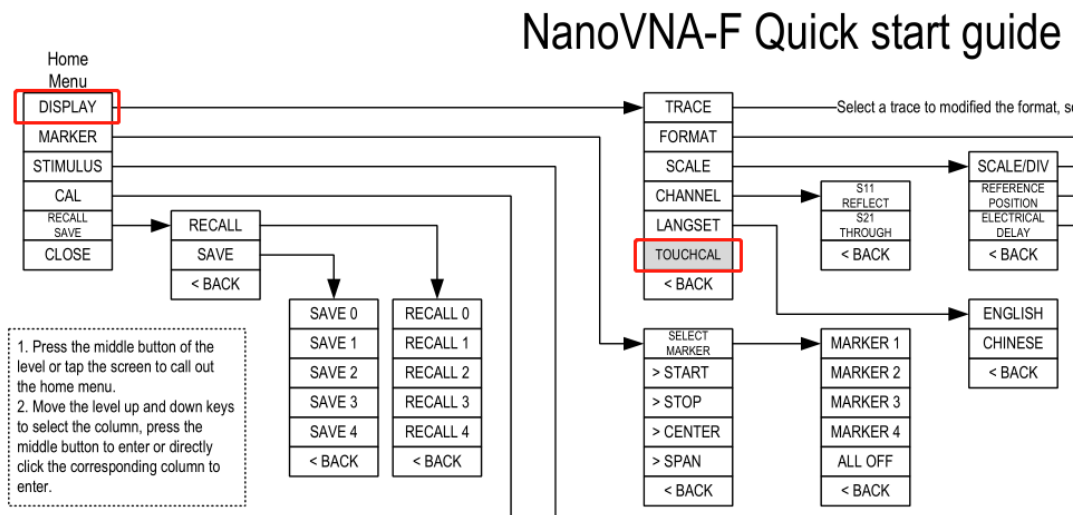

(2) Use a toothpick or other sharp object to click the center of the cross that appears in order.



(3) Done.

7. How do I upgrade the firmware ?

Download: <https://github.com/flyoob/NanoVNA-F>

Points to: https://github.com/flyoob/NanoVNA-F_Boot

(0) Download and unzip the update. You should have a file **update.bin**.

(1) Connect your NanoVNA-F to a PC's USB port using Type-C USB socket on the device. Press the selector switch and keep it down, while powering up the device. The LCD displays the following prompt, indicating that the boot-loader is active.

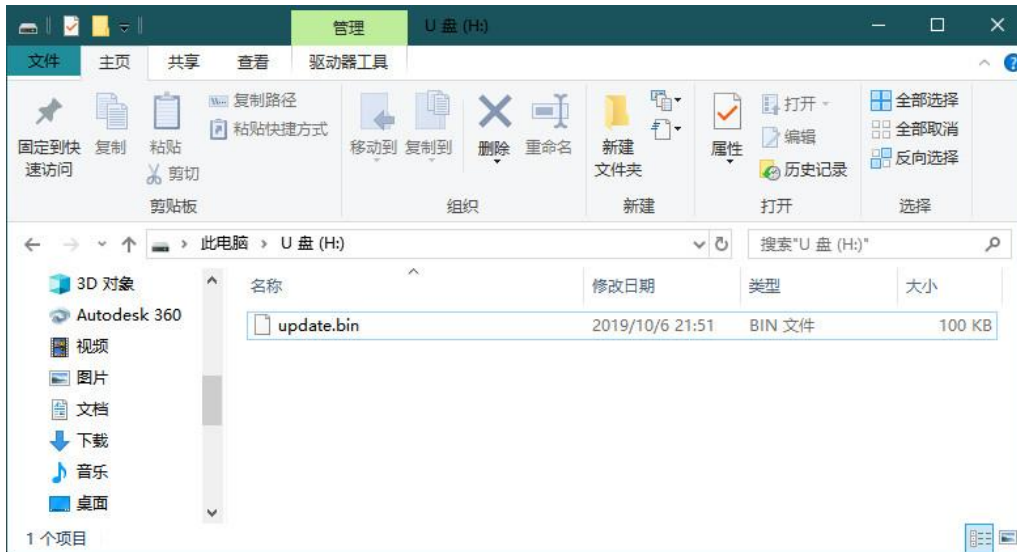

(3) Power the device off and on, and the boot-loader will run automatically, and update your NanoVNA-F. Re-power for normal operation.



8. How to add call sign display ?

(1) Connect your NanoVNA-F to a PC's USB port using Type-C USB socket on the device. Press the selector switch and keep it down, while powering up the device. The LCD displays the following prompt, indicating that the boot-loader is active.

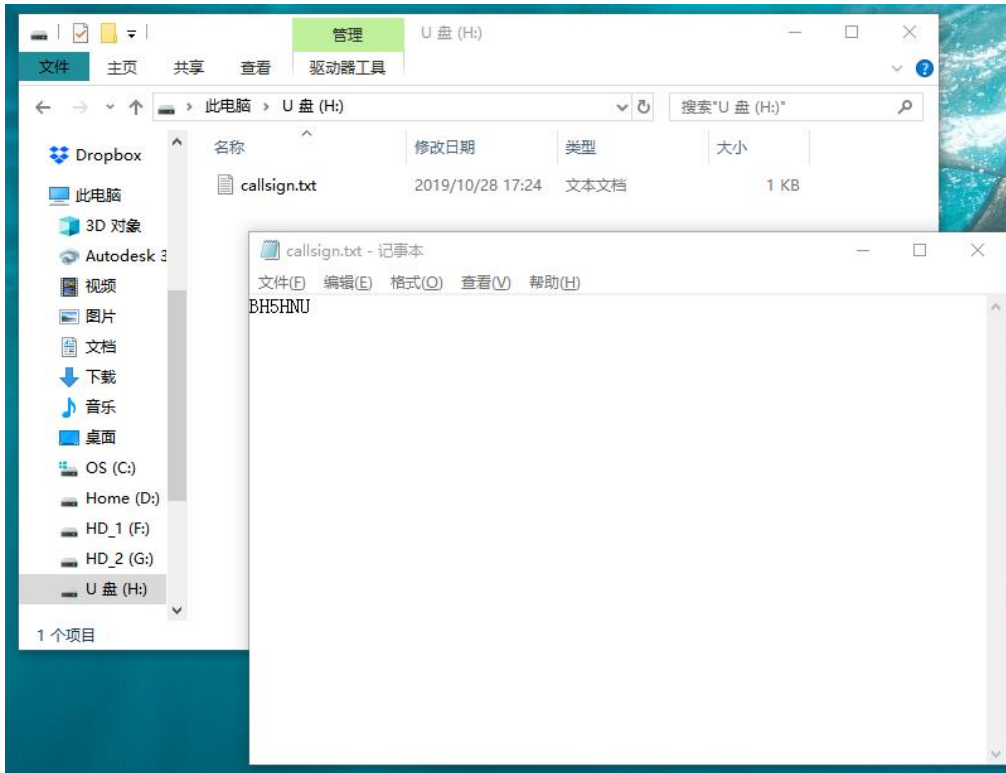

(2) Then at PC side, the device will act as a disk drive, which should appear in File Explorer. Copy your callsign.txt into the root directory of that disk, Re-power the device.

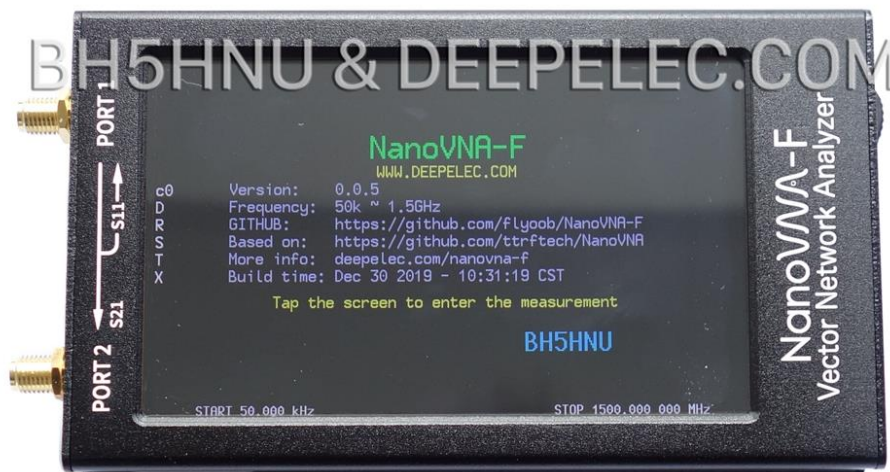

9. How to use PC software and how to install drivers ?

<http://deepelec.com/files/en.stsw-stm32102.zip>

Install the appropriate 32 or 64bit driver.

Turn ON the nano, attach to any USB port, and wait for the computer to give the "Installing driver" message. Wait until it completes.

We haven't released official PC software at this time, we recommend using nanovna-saver (by Rune B. Broberg), a powerful NanoVNA PC software.

<https://github.com/mihtjel/nanovna-saver>

