

YAESU
The radio

C4FM/FM 144/430MHz
DUAL BAND DIGITAL TRANSCEIVER

FTM-300DR

FTM-300DE

Operating Manual



Contents

Introduction	1	Repeater Operation	32
Quick Guide	2	Communicating Via the Repeater	32
Supplied Accessories and Options	3	Using the Memory	33
Supplied Accessories.....	3	Writing to memory (There are two ways)...	33
Available Options.....	3	Recall memory (There are two ways)	34
Name and function of each component	4	Recall only memories in the	
Panel (front).....	4	same frequency band (Band) using the	
Panel (Left and right side)	6	memory auto grouping (MAG) function.....	37
Panel (rear).....	6	M-GRP allows you to create groups of	
Main body (Front)	7	memory channels regardless of frequency... 38	
Main body (rear)	7	Multi Channel Standby (MCS) Function.....	38
Microphone (SSM-85D)	8	Edit memory	39
Display	10	Recalling the Home Channels.....	42
Descriptions of Main Screens	12	Changing the Home Channel Frequency....	42
About this manual	14	Split Memory	43
Safety Precautions (Be Sure to Read)	15	Scanning Function	44
Installing the Radio	17	VFO Scan/Memory Scan	44
About the antenna	17	Programmable Memory scan (PMS).....	44
Connection of Antenna and Power Cables.	17	Setting the Receive Operation	
Installing the transceiver	18	When Scanning Stops.....	45
Connecting the front panel to the		Skip Memory Channels	45
main body	18	Convenience Features	46
New Operating Concepts E2O-II		Bluetooth® Operation.....	46
(Easy to Operate-II)	19	VOX Operation	48
Using a Micro SD Memory Card	20	Band Scope	52
Usable microSD Memory Cards	20	Using the Voice Recorder	53
Mounting and Dismounting		Taking a Picture (Snapshot Function)	56
microSD Memory Card.....	20	GPS Function	58
Formatting a Micro SD Memory Card.....	20	WIRES-X function	58
Operation	21	APRS (Automatic Packet	
Turning the Transceiver ON	21	Reporting System) function.....	58
Adjusting the volume	22	Tone squelch feature.....	59
Adjusting the squelch level.....	22	Digital Code squelch (DCS) feature.....	59
Changing the operation band.....	22	New PAGER (EPCS) feature.....	59
Selecting a Frequency Band	23	Digital Personal ID (DP-ID) feature.....	59
Tuning to a Frequency.....	23	Using Setup Menu	60
Changing the Frequency Step.....	24	Setup Menu Operation	60
Selecting the Communication Mode	25	Tables of Setup Menu Operations	62
E2O-II (Easy to Operate-II)		Restoring to Defaults (Reset)	69
frequently used functions	26	All Reset	69
can be called with one touch.....	26	Memory Channels Reset.....	70
Fixing the Communication Mode	27	APRS Reset.....	70
Transmitting	27	Text input screen	71
Changing the Transmit Power Level	28	Specifications	72
Locking the Keys and DIAL knob	28	YAESU LIMITED WARRANTY	74
Using the convenient			
Digital C4FM features	29		
About the Digital Group ID (DG-ID) feature..	29		
Communicating with the DG-ID feature.....	29		

Features of the Yaesu FTM-300DR/DE Transceiver.

- Digital communication using Yaesu (C4FM (Quaternary FSK) system)
- Equipped with AMS (Automatic Mode Select) feature that automatically selects the analog FM or the C4FM digital modes, according to the signal of the other station.
- Simultaneous reception of two separate frequencies, on different bands, or within the same band (V+V/U+U).
- Memory Channel Band Auto Grouping (MAG). The memory channels are automatically categorized in each band, so that memory channels can be easily and quickly recalled.
- “E2O-II (Easy to Operate-II)”, which enables easier and smoother operation of frequently used functions, such as direct frequency input, memory channel recall, and signaling changes, which are used in the function menu.
- MCS (Multi Channel Standby) is a convenient function that can automatically watch multiple memory channels that are registered in each group of the MAG function (except for M-ALL).
- The DG-ID (Digital Group ID) feature (page 29), and the Group Monitor (GM) feature enable automatically locating, and communicating with other stations that are within contact range and have the matching DG-ID number, (Group ID number from 00 to 99).
- The 2-inch High-Resolution QVGA Full-Color TFT Display shows the communication status and settings of the FTM-300DR/DE in a straightforward manner, achieving excellent operability.
- Wide-band reception (108 MHz to 999.99 MHz) (USA Cellular Blocked)
- Built-in GPS unit permits display of the current location and heading information
- Equipped with Bluetooth® function as standard. Supports hands-free communication using the optional Bluetooth® headset SSM-BT10 or a commercially available product.
- Large-capacity 1104 memory channels
- 3W Audio Power Speaker with two individual jacks for the external speakers
- Heavy Duty-Heat Sink with FACC (Funnel Air-Convection Conductor)
- High-resolution band scope that displays 61 channels
- Smart Navigation function
- Snapshot function (optional camera/microphone MH-85A11U is required)
- WiRES-X Portable Digital Node or Fixed Node with HRI-200
- Equipped with digital GM (Group Monitor) function
- Ready for APRS® communication with world standard 1200 / 9600bps AX25 modem
- Digital Personal ID (DP-ID) feature
- Compatible with microSD memory cards

Thank you for purchasing the FTM-300DR/DE Transceiver. We urge you to read this manual in its entirety, and also the Advance Manual (available for download on the Yaesu website), to gain a full understanding of the amazing capability of the exciting new FTM-300DR/DE Transceiver.

WiRES-X, GM function and APRS instruction manuals are not included in the product package. They are available and may be downloaded from the Yaesu.com website.

Quick Guide

① Turn the Power ON

Press and hold the [POWER(LOCK)] switch.

② Input the Call sign

When turning the power ON for the first time after purchasing, input the call sign of your own station.

Input call sign may be changed from Setup Menu [CALLSIGN].

1. When turning the power ON for the first time after purchasing, the call sign input screen will be displayed.

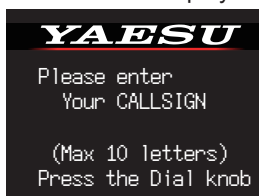

2. Press the **DIAL** knob (upper right).

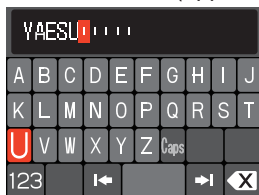

3. Input the call sign.
Rotate the **DIAL** knob to select each character and then press the **DIAL** knob.

: to move the cursor to the right.

: to move the cursor to the left.

: change to the numeric and symbol input

: to delete character to left of cursor

See "Text input screen" on page 71 to input a call sign.

4. Repeat step 3 to input the remaining call sign characters.
5. Press and hold the **DIAL** knob to conclude inputting.

Normal operation (VFO Mode) screen will be displayed.

③ Select the Operating Band

Press the [BAND] key.

④ Tune the frequency

Rotate the **DIAL** knob.

⑤ Adjust the volume

Rotate the **VOL** knob (upper left or upper right) to adjust the volume to a comfortable level.

⑥ Adjust the squelch setting

The squelch level may be adjusted to mute the background noise when no signal is received

1. Press the [SQL] key.
2. Rotate the **DIAL** knob to adjust the squelch to a level at which the background noise is muted.

*When the squelch level is increased, the noise is more likely to be silenced, but it may become more difficult to receive weak signals.

3. Press the [SQL] key again or wait for about 3 seconds to complete the adjustment.

⑦ Select the communication mode

In the factory settings, the communication mode automatically corresponds to the signal being received.

* Touch [D X] key to manually select the communication mode.

⑧ Transmit/Receive Signals

Talk into the microphone while holding the **PTT** switch on the side. Release the **PTT** switch to return to receive.

⑨ Set the Bluetooth® function

The FTM-300DR/DE is equipped with the Bluetooth function. To use a Bluetooth headset, refer to "Bluetooth® Operation" on page 46 for setting.

Supplied Accessories

- DTMF microphone SSM-85D
- DC power cable (with fuse attached)
- Control cable
- Control cable 10ft (3m)
- Bracket for main body
- Bracket for the controller
- USB Cable
- Spare fuse (15A)
- Operating Manual (This Manual)



If any item is missing, contact the dealer from which you purchased the transceiver.

Available Options

- | | |
|--|-----------|
| • Microphone with Snapshot Camera | MH-85A11U |
| • DTMF Microphone | SSM-85D |
| • Microphone | MH-42C6J |
| • Bluetooth® Headset | SSM-BT10 |
| • High-Power External Speaker | MLS-100 |
| • Voice Guide Unit | FVS-2 |
| • Vacuum Cup Mount Bracket for Front Panel Controller | MMB-98 |
| • Charging Cable for Bluetooth® Headset SSM-BT10 | SCU-41 |
| • Mic Extension Cable 10ft (3m) for MH-85A11U | SCU-23 |
| • Mic Extension Kit 10ft (3m) for SSM-85D and MH-42C6J | MEK-2 |
| • Control Cable 20ft (6m) | SCU-47 |
| • Cloning Cable | CT-166 |
| • WIRES-X Connection Cable kit | SCU-40 |
| • Data Cable (MDIN10 pin to MDIN6 pin + Dsub9) | CT-163 |
| • Data Cable (MDIN10 pin to MDIN6 pin) | CT-164 |
| • Data Cable (MDIN10 pin to Dsub9) | CT-165 |
| • Data Cable (MDIN10 pin to Open) | CT-167 |

Name and function of each component

Panel (front)

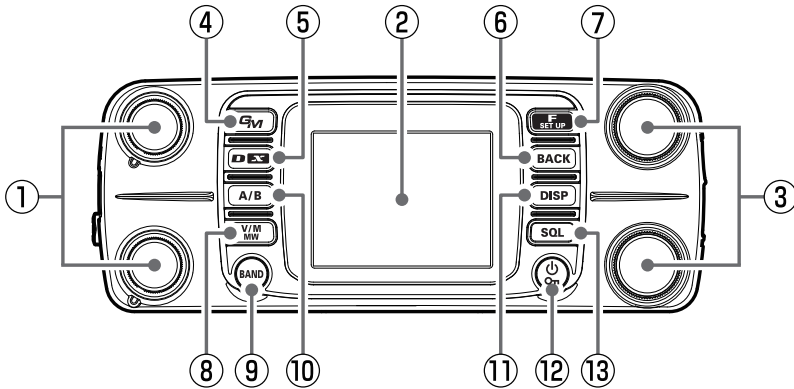

① VOL knob

Rotate the VOL Knob to adjust the audio volume level.

VOL knob (Upper): A-Band

VOL knob (Lower): B-Band

② Full color screen display

③ DIAL knob

DIAL knob (Upper): A-Band

DIAL knob (Lower): B-Band

- Press the **DIAL** knob to enable setting the operating band frequency in 1 MHz units.
- Press and hold the **DIAL** knob to enable setting the frequency in 5 MHz units.
- Press the **SQL** key, then rotate the **DIAL** knob to adjust the squelch level.

④ GM key

- Press to turn the GM (group monitor) function ON/OFF.

(For details on the function, refer to the GM Function Instruction Manual which may be downloaded from the Yaesu website.)

- Press and hold to enter DG-ID number setting screen.

1. Rotate the **DIAL** knob to select [**DG-ID TX**] (Transmit DG-ID number), and then press the **DIAL** knob.
2. Rotate the **DIAL** knob to select the DG-ID number from 00 to 99, and then press the **DIAL** knob.
3. Similarly, set [**DG-ID RX**] (receive DG-ID number).
 - While setting the DG-ID number, pressing and holding the **DIAL** knob will set the transmit and the receive DG-ID numbers to "00".

⑤ D X key

- Each time this key is pressed for a short time the communication mode changes:

AMS(**FM**) / (**FM**) → DN → DN → DN ...

Normally, the communication mode is automatically set to the mode of the partner station, by setting to "AMS" (AMS display example: **FM** / **FM**), which can receive the signal of the partner station.

- Press and hold the [**D X**] key to start the WIRES-X.

The WIRES-X enables long-distance communication in digital communication systems via the Internet. (For details on this function, refer to the WIRES-X Function Instruction Manual which may be downloaded from the Yaesu website.)



- Press and hold the [**D X**] key again to return to the normal operation screen.

⑥ BACK key

Press the [**BACK**] key to return to the previous screen.

⑦ F(SETUP) key

- Press the [**F(SETUP)**] key to display the function menu screen. Rotate the **DIAL** knob to select an item and perform the functions and make settings.
- Press and hold the [**F(SETUP)**] key to enter set-up menu. The Set Mode permits configuring the various functions according to individual operating needs and preferences. (Refer to page 60).

ENTER FREQUENCY (VFO mode) ENTER MEMORY CH (MEMORY mode)	
ENTER FREQUENCY	
Rotate the DIAL knob to select a number then press the DIAL knob. If you press and hold the DIAL knob, everything after the current digit is entered as "0".	
ENTER MEMORY CH	
Rotate the DIAL knob to select the memory channel number, then press the DIAL knob. Press and hold the DIAL knob to confirm and complete the memory entry.	

FUNCTION	
REV	Reverse the transmit and receive frequencies temporarily.
DTMF	Select a registered DTMF memory channel.
DTMF MEMORY	Register DTMF memory (up to 16 digits).
LOG LIST	Display the Log List screen.
TXPWR	Select the transmit power. HI → LO → MD → HI ...
SQ-TYP	Select a squelch type. TN : CTCSS tone TSQ : CTCSS tone squelch RTN : Reverse tone squelch DCS : Digital code squelch PR : No-communication Squelch PAG : PAGER (EPCS) DC : Transmits the DCS T-D : TX: CTCSS tone RX: Digital Code Squelch D-T : TX: Digital Code Squelch RX: CTCSS tone squelch OFF : Normal squelch operation *The options in the parentheses are available when the SQL expansion is ON.
TONE/CODE	Setting the CTCSS tone or the DCS code.
REC/STOP	Start or stop recording the received audio on the microSD card.

APRS FUNCTION	
STN LIST	Displays the APRS station list screen.
BEACON	Set "ON" / "OFF" for automatic transmission of APRS beacon.
MSG LIST	Displays the APRS message list screen.
BCN-TX	Transmit APRS beacon.

FVS-2 (Only available when the optional voice guide unit FVS-2 is installed)	
M.REC	Start recording the received audio to FVS-2.
TRACK	Select the track number recorded on FVS-2.
PLAY	Start replaying the recorded audio on FVS-2.
STOP	Stop recording / replay
CLEAR	Deletes all recorded contents of FVS-2.
VOICE GUIDE	The frequency of the operating band will be announced.

⑧ V/M(MW) key

Each key press switches between VFO mode and memory mode.

When a memory channel is recalled, the memory channel number is displayed, such as "M-ALL 001". The last operated memory channel is recalled.

Press and hold the key to display the memory channel list screen.

Writing to memory or recalling and editing of stored memory channel.

⑨ BAND key

VFO mode

Each key press switches the operating frequency band.

Band	Selectable Frequency Range
AIR	108MHz - 137MHz
144MHz	137MHz - 174MHz
VHF	174MHz - 400MHz
430MHz	400MHz - 480MHz
UHF	480MHz - 999.99MHz

Memory mode

Each time the key is pressed (except M-GRP), only memory channels of the same frequency band are automatically recalled as a group as shown below.

M-ALL (All memory channels)

M-AIR (AIR band memory channels)

M-VHF (144MHz band memory channel)

M-UHF (430MHz band memory channel)

M-GEN (VHF and UHF band memory channels)

M-GRP (Memory channels registered in advance regardless of the frequency band)

Bands that have not been stored are not displayed.

⑩ A/B key

Select the operation band.

Each press key between A band (frequency at the top of the screen) and B band (frequency at the bottom of the screen).

- The operating band is white and the other band is gray.

⑪ **DISP key**

Press the key to display the scope screen with the current frequency or memory channel as the center and the status of the upper and lower channels (received signal strength) in a graph.

Press the key again to return to the normal screen.

⑫ **POWER (Om) Switch**

Press and hold this button to switch the power ON or OFF.

When the power is ON, press this button briefly to engage, or release the key lock.

⑬ **SQL key**

Press the SQL key, then rotate the **DIAL** knob to adjust the squelch level. The squelch level may be adjusted to mute the background noise when no signal is present.

Panel (Left and right side)

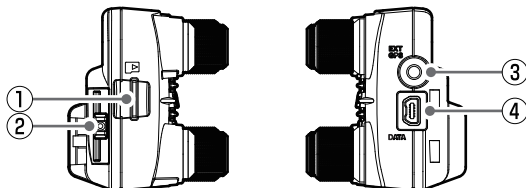

① **micro-SD card slot**

Insert a commercially available micro SD card to backup the various radio settings, memory channels, recordings of received audio, and recordings of snapshot images, etc.

② **Release knob**

Press to release the control panel from the transceiver.

③ **EXT GPS jack**

Plug in a cable to connect with external GPS devices. The communication baud rate is fixed at 9600bps.

④ **DATA jack**

- Connect MH-85A11U optional microphone with snapshot camera.

*It is not possible to output the receive audio from the MH-85A11U speaker.

- Connect SCU-41 charging cable to charge the SSM-BT10 Bluetooth® headset .
- When updating the firmware (Sub), connect to the PC with the included USB cable.

Panel (rear)

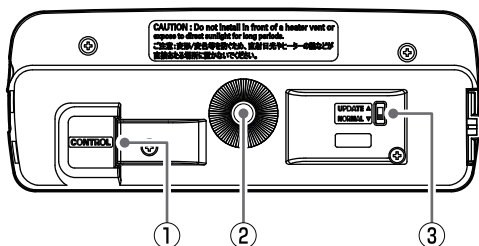

① **CONTROL jack**

Plug in the control cable into this jack to connect with the main body.

② **Screw hole for bracket**

Attach the supplied panel bracket or the optional adjustable angle suction type control panel bracket MMB-98 with the supplied screws.

③ **Firmware Update switch**

This switch is used when updating the firmware (Sub).

Normally set to "NORMAL" position.

* Please refer to YAESU website for firmware updates.

Main body (Front)

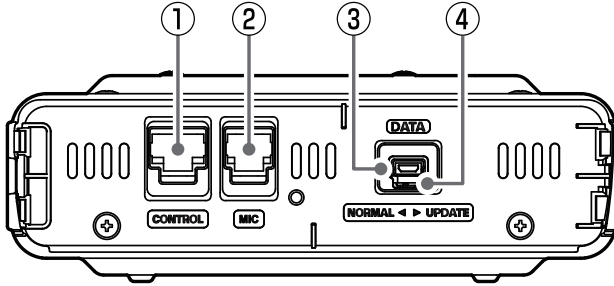

① CONTROL jack

Plug the control cable into this jack to connect with the control panel.

② MIC jack

Connect the cable of the included DTMF microphone SSM-85D or the optional microphone MH-42C6J.

③ DATA jack

When updating the firmware (Main / DSP), connect to the PC with the included USB cable. The optional microphone MH-85A11U cannot be connected to this jack.

④ Firmware Update switch

This switch is used when updating the firmware (Main).

Normally set to "NORMAL" position.

* Please refer to YAESU website for firmware updates.

Main body (rear)

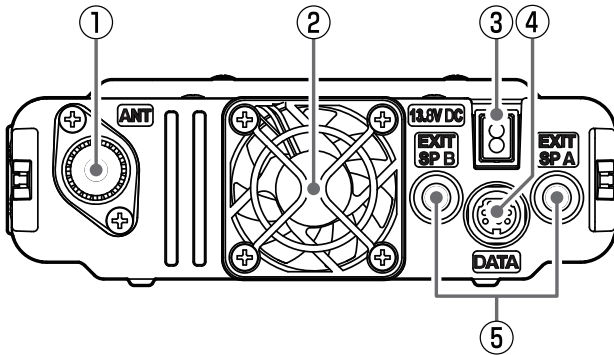

① ANT terminal

Connect the co-axial cable for the antenna.

② Cooling fan

③ 13.8V DC

Connect the provided DC power supply cable (with fuse attached).

④ DATA Jack

Connect a cable for remote operation, or the cable to connect with the PC interface unit and the external terminal unit.

⑤ EXT SP A jack / EXT SP B jack

For the operation when external speakers are connected to each jack, see the following:

	External Speaker A	External Speaker B	Internal Speaker
Connect to A only	A band and B band audio	-	-
Connect to B only	-	B band audio	A band audio
Connect to both A and B	A band audio	B band audio	-

Microphone (SSM-85D)

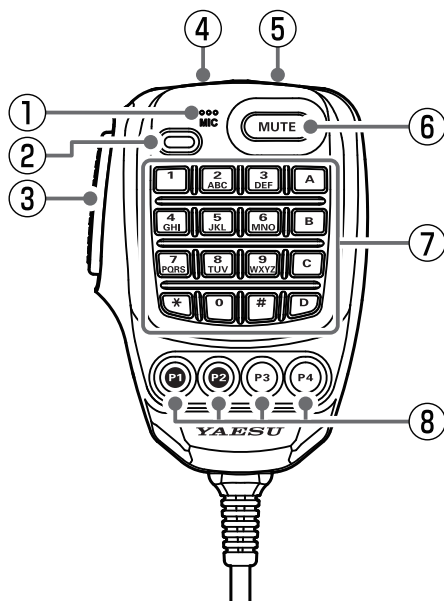

① MIC

Speak into the microphone during transmission.

② TX LED

Lights red while pressing PTT switch.

③ PTT

Press and hold the PTT switch to transmit, and release it to receive.

Press this key during the set mode to exit the set mode.

④ DWN

Press this button to move the frequency or memory channel lower by one step, press and hold it to start scanning.

⑤ UP

Press this button to move the frequency or memory channel up by one step, press and hold it to start scanning.

⑥ MUTE

Press this button to mute the receive audio. Press it again to unmute the audio.

⑦ DTMF keypad

Press these keys during transmit to enter and send a DTMF sequence. The following operations can be performed during receive.

0 - 9 : Enter the frequency or memory channel number.

A : The operation band switches to A band (the upper frequency on the screen).

B : The operation band switches to B band (the lower frequency on the screen).

C : Adjust the squelch level.

D : The band scope function operates.

* : Each press switches between VFO mode and memory mode.

: This key has the same function as the [BAND] key on the controller.

VFO mode:

Each press changes the operating frequency band.

AIR → 144MHz → VHF → 430MHz → UHF

Memory mode:

Each time the key is pressed only memory channels of the same frequency band (except M-GRP) are automatically recalled as a group, as shown below:

M-ALL → M-AIR → M-VHF →

M-UHF → M-GEN → M-GRP

* Bands that have not been stored are not displayed.

⑧ Program keys (P1/P2/P3/P4)

The default function settings of the [P1] / [P2] / [P3] / [P4] keys are shown in the table below.

Key	Function	Press	Press and hold
P1*	GM*	GM Function	DG-ID setting screen
P2	HOME	Recalls HOME channel	
P3	D_X	Selects communication mode	Activates the WIRES-X feature
P4	WX (T-CALL)	WX (T-CALL: European version)	

*The function of the [P1] key is fixed.

The functions of the [P2] / [P3] / [P4] keys can be assigned by the following operations:

1. Press and hold the **[F(SETUP)]** key.
2. Rotate the **DIAL** knob to select Set-up menu **[CONFIG]**, then press the **DIAL** knob.
3. Rotate the **DIAL** knob to select **[10 MIC PROGRAM KEY]**, then press the **DIAL** knob.
4. Rotate the **DIAL** knob to select a key to assign a function **[P2] / [P3] / [P4]** then press the **DIAL** knob.
5. Rotate the **DIAL** knob to select a function (see the table below) then press the **DIAL** knob.

Function	Description
OFF	(disable the P key)
BAND SCOPE	Turns the band scope function ON/OFF
SCAN	Starts or stops the scanning function
HOME	Recalls the HOME channel
RPT SHIFT	Sets the repeater shift direction
REVERSE	Reverses the transmit and receive frequencies in repeater mode or split memory.
TX POWER	Selects the transmit power output level
SQL OFF	Opens the squelch (SQL off)
T-CALL	Transmits the T-CALL(1750 Hz)
VOICE	Announces the current frequency (requires optional FVS-2)
D_X	Press to select communication mode Press and hold to activate the WIRES-X feature
WX	Switches operation to the Weather Channel Bank
STN LIST	Displays the APRS function station list
MSG LIST	Displays the message list of the APRS function
REPLY	Enters the APRS function reply message write mode
MSG EDIT	Enters the APRS function message write mode

Display

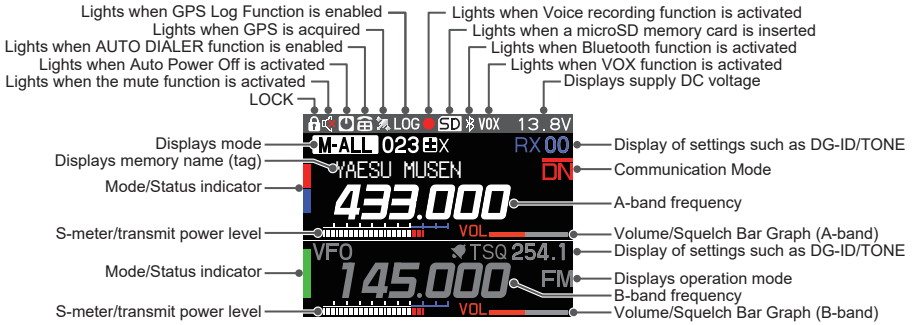

● Status Bar



Appears when the lock function is enabled.



Appears when the Mute function for B-band is enabled.



Appears when the APO (Automatic Power-Off) function is enabled.



Appears when the DTMF Autodialer function is activated.



Appears when the GPS Satellites are acquired.



Appears when the GPS Log function is enabled.



Appears when the Voice recording function is activated. (About 3 seconds after the squelch closes, the recording pauses and a "||" appears.)



Appears when a microSD card is inserted.



Appears when the Bluetooth function is activated.

Appears: Bluetooth device is connected.

Blinks: Bluetooth device not connected.



Appears when the VOX function is enabled.

● A-band / B-band display area

M-ALL

Memory channels of the same frequency band are automatically grouped and recalled as follows by the memory auto grouping (MAG) function.

M-AIR

M-ALL : Recalls all memory channels regardless of frequency band

M-VHF

M-AIR : Recalls only memory channels in the AIR band.

M-UHF

M-VHF : Recalls only memory channels in the 144 MHz band.

M-GEN

M-UHF : Recalls only memory channels in the 430 MHz band.

M-GRP

M-GEN : Recalls only VHF and UHF memory channels.
M-GRP : Recalls only memory channels registered in advance in M-GRP, regardless of frequency band

VFO

VFO mode

HOME

HOME Channel



: Repeater minus (-) shift



: Repeater plus (+) shift



: Split operation



Skip Memory Channel
(Permits designating undesired channels to be skipped during scanning.)



Bell function is activated.

TX00

TX/RX DG-ID is displayed

RX00

TX00 : TX DG-ID is displayed

RX00 : RX DG-ID is displayed

TN

Squelch type is displayed (For additional details, refer to the Advanced Manual.)

TN : Tone Encoder (tone frequency is displayed)

TSQ

TSQ : Tone Squelch (tone frequency is displayed)

RTN

RTN : Reverse Tone (tone frequency is displayed)

DCS

DCS : DCS (Digital Code Squelch) (DCS code is displayed)

PR

PR : No-communication Squelch

PAG

PAG : Pager (EPCS)

DC

The following can be set when the squelch expansion (see page 63) is "ON":

DC : Send the DCS code only during transmission. (DCS code is displayed)

T-D

T-D : Send the CTCSS tone signal during transmit, and wait for the DCS code in receive mode. (tone frequency is displayed)

D-T

D-T : Send the DCS code during transmit, and wait for the CTCSS tone signal in receive mode. (tone frequency is displayed)

Displays the operating mode (Digital modes are indicated by a red icon)

FM : FM (Analog) mode

DN : V/D mode (Simultaneous voice and data communication mode)

VW : Voice FR mode (Voice full-rate mode)

DW : Data FR mode (High speed data communication mode)



FM : AMS (Automatic Mode Select) FM (Analog) mode

DN : AMS (Automatic Mode Select) DN mode

VW : AMS (Automatic Mode Select) VW mode

DW : AMS (Automatic Mode Select) DW mode

*When AMS (Automatic Mode Select) function is activated, the indicator is shown with a bar appearing above the mode. The transceiver automatically switches to the DW mode during image transmission.



: S meter (Displays received signal strength in 10 levels)

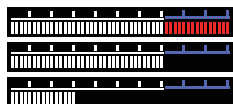

: PO meter (Displays transmit output in 3 levels when transmitting)



: Volume level



: SQL level

Descriptions of Main Screens

● Normal screen (VFO screen)



A-band and B-band are displayed in a top-down fashion. Both bands are received simultaneously.

* C4FM digital signal standby is available in both A-band and B-band. If digital signals are received in both bands, the operation band has priority.

● Band Scope screen

Press the [DISP] key to display the Band Scope screen.

The strengths of received signals above and below the current frequency or memory channel are shown in a graph while sweeping at high speed. The audio of the center frequency is heard without interruption.

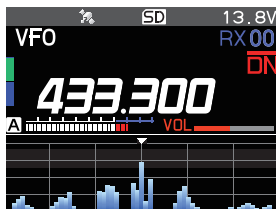

- Rotate the DIAL knob to change the frequency or memory channel.
- In VFO mode 61 or 31 channels can be searched. In memory mode 21 or 11 channels can be searched by the Band Scope (See “Change the number of channels displayed” (page 52))

● **Function Menu screen**

Press the [F(SETUP)] key to display the function menu screen.

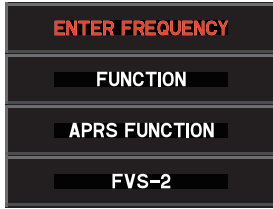

- [ENTER FREQUENCY] / [MEMORY CH]
Enter a number directly to set the frequency or recall a memory channel.
- [FUNCTION]
Performs basic functions and settings.
- [APRS FUNCTION]
Performs operations related to APRS function
- [FVS-2]
Perform the operations related to the optional FVS-2.

● **SETUP MENU screen**

Press the [F(SETUP)] key to display the setup menu screen.

The Setup Menu allows selecting various functions from the displayed list and then setting the parameters of each function according individual preferences.

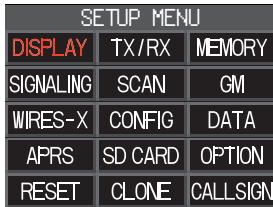

To return to the normal operation screen from the setup menu, press the DISP key.

To return to the previous screen, press the [BACK] key.

● **BACKTRACK screen**

Press and hold [F(SETUP)] → [DISPLAY] → [6 DISPLAY MODE] → [BACKTRACK]

• **Real-time navigation function**

Displays the position and direction of the other station in real time during communication in C4FM digital V/D mode (The signal of the other station must contain GPS location information). It is also possible to switch the display to show the traveling direction of your own station and the distance to the destination.

• **BACKTRACK function**

Register up to three locations (“★”, “L1”, “L2”), such as the departure point or the current location of the other station, then display and navigate in real time the distance and direction of the registered location as viewed from the current location.

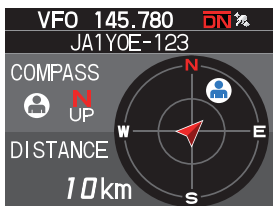

- Displays the position of other stations (“” icon is displayed)
[F(SETUP)] → [MEM] → [★], [L1], [L2]
Stores the current position of the other station.
- Displays the direction of your station (“” icon is displayed)
[F(SETUP)] → [MEM] → [★], [L1], [L2]
Stores the current position of the your station.
- [F(SETUP)] → [★], [L1], [L2]
Start navigation to the registered point.

● GPS Information screen

Press and hold [F(SETUP)]→[DISPLAY]→[6 DISPLAY MODE]→[GPS INFORMATION]

Displays the status of signals received from GPS satellites and related information.

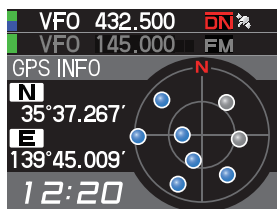

The following information is displayed:

- Direction and elevation of satellites
- Current latitude and longitude
- Local Time

● Altitude screen

Press and hold [F(SETUP)] → [DISPLAY] → [6 DISPLAY MODE] → [ALTITUDE]

The altitude versus the moving distance is displayed in a graph using the GPS signal.

● TIMER/CLOCK screen

Press and hold [F(SETUP)] → [DISPLAY] → [6 DISPLAY MODE] → [TIMER/CLOCK]

CLOCK, LAP timer and Countdown timer functions are available.

About this manual

The following notation is also used in this manual.



This icon indicates cautions and information that should be read.



This icon indicates notes, tips and information that should be read.

PLEASE NOTE: Due to product improvements, some of the illustrations in the instruction manual may differ from the actual product.

Safety Precautions (Be Sure to Read)

Be sure to read these important precautions, and use this product safely.

Yaesu is not liable for any failures or problems caused by the use or misuse of this product by the purchaser or any third party. Also, Yaesu is not liable for damages caused through the use of this product by the purchaser or any third party, except in cases where ordered to pay damages under the laws.

Types and meanings of the marks



DANGER

This mark indicates an imminently hazardous situation, which, if not avoided, could result in death or serious injury.



WARNING

This mark indicates a potentially hazardous situation, which, if not avoided, could result in death or serious injury.



CAUTION

This mark indicates a potentially hazardous situation, which, if not avoided, may result in minor or moderate injury or only property damage.

Types and meanings of symbols



These symbols signify prohibited actions, which must not be done to use this product safely. For example:  indicates that the product should not be disassembled.



These symbols signify required actions, which must be done to use this product safely. For example,  indicates that the power plug should be disconnected.



DANGER

 **Do not use the device in "regions or aircrafts and vehicles where its use is prohibited" such as in hospitals and airplanes.**

This may exert an impact on electronic and medical devices.

 **Do not use this product while driving or riding a motorbike. This may result in accidents.**

Make sure to stop the car in a safe location first before use if the device is going to be used by the driver.

 **Do not operate the device when flammable gas is generated.**

Doing so may result in fire and explosion.

 **Never touch the antenna during transmission.**

This may result in injury, electric shock and equipment failure.



Do not transmit in crowded places in consideration of people who are fitted with medical devices such as heart pacemakers.

Electromagnetic waves from the device may affect the medical device, resulting in accidents caused by malfunctions.



When an alarm goes off with the external antenna connected, cut off the power supply to this radio immediately and disconnect the external antenna from this radio.

If not, this may result in fire, electric shock and equipment failure.



Do not touch any liquid leaking from the liquid display with your bare hands.

There is a risk of chemical burns occurring when the liquid comes into contact with the skin or gets into the eyes. In this case, seek medical treatment immediately.



WARNING

 **Do not use voltages other than the specified power supply voltage.**

Doing so may result in fire and electric shock.

 **Do not transmit continuously for long periods of time.**

This may cause the temperature of the main body to rise and result in burns and failures due to overheating.

 **Do not dismantle or modify the device.**

This may result in injury, electric shock and equipment failure.

 **Do not handle the power plug and connector etc. with wet hands. Also do not plug and unplug the power plug with wet hands.**

This may result in injury, liquid leak, electric shock and equipment failure.



When smoke or strange odors are emitted from the radio, turn off the power and disconnect the power cord from the socket.

This may result in fire, liquid leak, overheating, damage, ignition and equipment failure. Please contact our company amateur customer support or the retail store where you purchased the device.



Keep the power plug pins and the surrounding areas clean at all times.

This may result in fire, liquid leak, overheating, breakage, ignition etc.





Disconnect the power cord and connection cables before incorporating items sold separately and replacing the fuse.

This may result in fire, electric shock and equipment failure.

 **Never cut off the fuse holder of the DC power cord.**
This may cause short-circuiting and result in ignition and fire.

 **Do not use fuses other than those specified.**
Doing so may result in fire and equipment failure.

 **Do not allow metallic objects such as wires and water to get inside the product.**
This may result in fire, electric shock and equipment failure.

 **Do not place the device in areas that may get wet easily (e.g. near a humidifier).**
This may result in fire, electric shock and equipment failure.

 **When connecting a DC power cord, pay due care not to mix up the positive and negative polarities.**
This may result in fire, electric shock and equipment failure.

 **Do not use DC power cords other than the one enclosed or specified.**
This may result in fire, electric shock and equipment failure.

 **Do not bend, twist, pull, heat and modify the power cord and connection cables in an unreasonable manner.**
This may cut or damage the cables and result in fire, electric shock and equipment failure.

 **Do not pull the cable when plugging and unplugging the power cord and connection cables.**
Please hold the plug or connector when unplugging. If not, this may result in fire, electric shock and equipment failure.

 **Refrain from using headphones and earphones at a loud volume.**
Continuous exposure to loud volumes may result in hearing impairment.

 **Do not use the device when the power cord and connection cables are damaged, and when the DC power connector cannot be plugged in tightly.**
Please contact our company amateur customer support or the retail store where you purchased the device as this may result in fire, electric shock and equipment failure.

 **Follow the instructions given when installing items sold separately and replacing the fuse.**
This may result in fire, electric shock and equipment failure.

 **Do not use the device when the alarm goes off.**
For safety reasons, please pull the power plug of the DC power equipment connected to the product out of the AC socket.

 **Never touch the antenna as well.** This may result in fire, electric shock and equipment failure due to thunder.

CAUTION

 **Do not place this device near a heating instrument or in a location exposed to direct sunlight.**
This may result in deformation and discoloration.

 **Do not place this device in a location where there is a lot of dust and humidity.**
Doing so may result in fire and equipment failure.

 **Stay as far away from the antenna as possible during transmission.**
Long-term exposure to electromagnetic radiation may have a negative effect on the human body.

 **Do not wipe the case using thinner and benzene etc.**
Please use a soft and dry piece of cloth to wipe away the stains on the case.

 **Keep out of the reach of small children.**
If not, this may result in injuries to children.

 **Do not put heavy objects on top of the power cord and connection cables.**
This may damage the power cord and connection cables, resulting in fire and electric shock.

 **Do not transmit near the television and radio.**
This may result in electromagnetic interference.

 **Do not use optional products other than those specified by our company.**
If not, this may result in equipment failure.

 **When using the device in a hybrid car or fuel-saving car, make sure to check with the car manufacturer before using.**
The device may not be able to receive transmissions normally due to the influence of noises from the electrical devices (inverters etc.) fitted in the car.

 **For safety reasons, switch off the power and pull out the DC power cord connected to the DC power connector when the device is not going to be used for a long period of time.**
If not, this may result in fire and overheating.

 **Do not throw or subject the device to strong impact forces.**
This may result in equipment failure.

 **Do not put this device near magnetic cards and video tapes.**
The data in the cash card and video tape etc. may be erased.

 **Do not turn on the volume too high when using a headphone or earphone.**
This may result in hearing impairment.

 **Do not place the device on an unsteady or sloping surface, or in a location where there is a lot of vibration.**
The device may fall over or drop, resulting in fire, injury and equipment failure.

 **Do not stand on top of the product, and do not place heavy objects on top or insert objects inside it.**
If not, this may result in equipment failure.

 **Do not use a microphone other than those specified when connecting a microphone to the device.**
If not, this may result in equipment failure.

 **Do not touch the heat radiating parts.**
When used for a long period of time, the temperature of the heat radiating parts will get higher, resulting in burns when touched.

 **Do not open the case of the product except when replacing the fuse and when installing items sold separately.**
This may result in injury, electric shock and equipment failure.

About the antenna

The antenna is an extremely important part for both transmitting and receiving. The antenna type and its inherent characteristics determine whether the performance of the transceiver can be fully realized. As such, please note the following:

- Use an antenna that is suitable for the installation conditions and application objective.
- Use an antenna that is suitable for the operating frequency band.
- Use an antenna and a coaxial cable with a characteristic feed point impedance of 50Ω .
- Adjust the VSWR (Voltage Standing Wave Ratio) until it is 1.5 or less for an antenna with an adjusted impedance of 50Ω .
- Keep the coaxial cable routing length as short as possible.

Connection of Antenna and Power Cables

Please follow the outline in the illustration regarding the proper connection of antenna coaxial cables and Power Supply.

Cautions

- Do not use a DC power supply cable other than the one that is provided.
- Do not use the DC power supply cable with the fuse holder cut off.
- Use an external power source capable of supplying DC 13.8 V, a current capacity of 15 A or more.

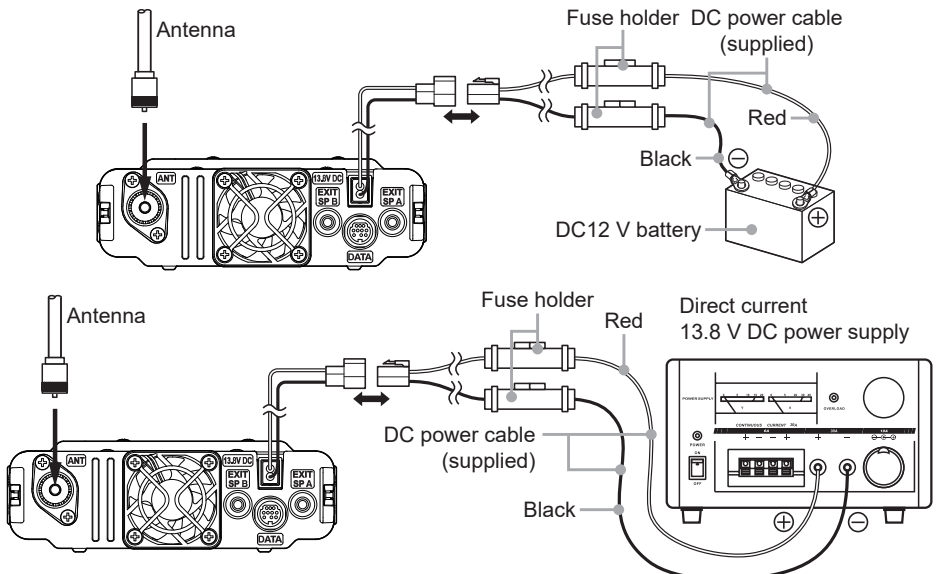

Installing the transceiver

Install the main body and the front panel using the supplied brackets.



- The bracket can be formed by hand to match the location where the front panel is installed.
- Be careful not to cause an injury when bending the bracket.
- The front panel has a built-in GPS antenna. It is recommended to install on the dashboard or in front of the center console to receive the radio wave from GPS efficiently.

1. Select the installation location.

Caution : Select a location where the transceiver can be securely attached.

2. Drill four 6mm diameter holes in the location where the bracket is to be mounted, matching the positions of the bolting holes of the bracket.
3. Insert the grooves on both sides of the main body into the bracket until they click and lock. Tighten the screw against the lever to lock the transceiver in the bracket.
4. To remove the main body from the bracket, loosen the locking screw, and then pull the transceiver out while pressing the lever indicated by the arrow below.

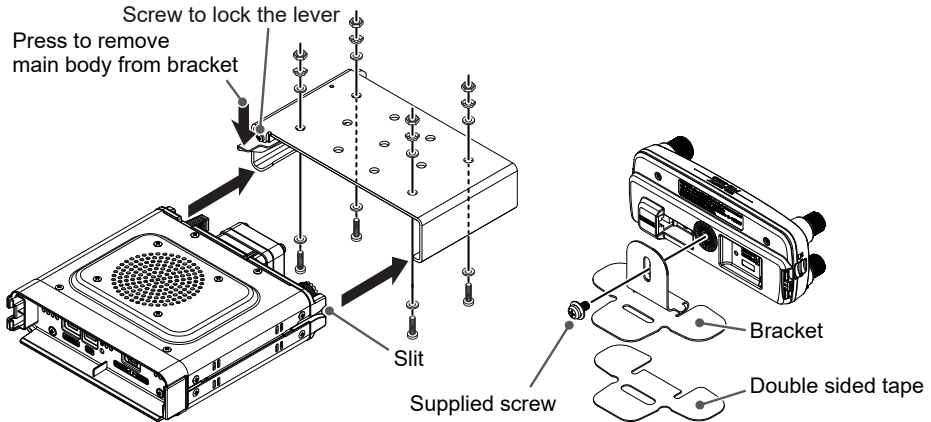

Connecting the front panel to the main body

Connect the transceiver to the “**CONTROL**” terminal of the control panel with the included control cable. Connect the cable of the supplied microphone SSM-85D to the “**MIC**” terminal of the transceiver.

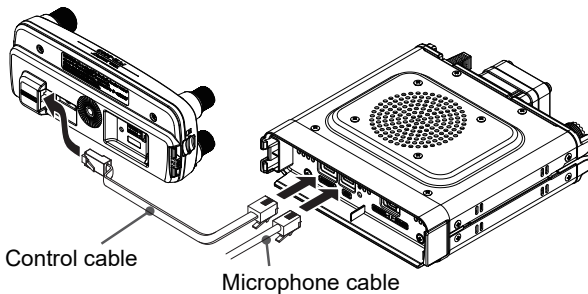

- ① **Function pop-up screen** page 26
Frequently used functions can be easily selected on the function pop-up screen.
The following four functions can be operated from the function pop-up screen.

● **ENTER FREQUENCY/MEMORY CH**

● **FUNCTION**

REV Transmit and the receive frequencies are temporarily reversed

DTMF/DTMF MEMORY DTMF registration and transmission

LOG LIST Display of received messages and images

TXPWR Transmit power output

SQ-TYP Change squelch type

CODE/TONE Change DCS code or CTCSS tone frequency

REC Perform record and playback operations

● **APRS FUNCTION**

Operations related to APRS operation

● **FVS-2**

Recording and playback operations using the optional voice guide unit FVS-2

- ② **Memory Auto Grouping (MAG) function** page 37

Memory channels of the same frequency band can be easily recalled automatically as a group.

Each time the [BAND] key is pressed during memory mode operation, the band switches in the following order: ALL → AIR → VHF → UHF → GEN → GRP. Only memory channels of that frequency band can be automatically grouped and recalled.

- ③ **Multi-Channel Standby (MCS) function**..... page 38

This is a convenient function that can automatically monitor multiple memory channels registered in each group of the MAG function (except for M-ALL).

When a signal is received, MAG group watch pauses on that channel until 5 seconds after receiving is completed, so communications may be established. When there is no transmit or receive operation for about 5 seconds, the watch of the memory channels registered to the same group starts again.

- ④ **Improvement of operation system**

All operating systems such as key layout and control logic have been examined in detail, improved and optimized. Functions can be installed and enabled intuitively. Easy and stress-free operation is unprecedented.

Using a Micro SD Memory Card

Using a microSD memory card with the transceiver allows the following functions.

- Backing up the transceiver data and information
- Saving memory information
- Voice recording and playback
- Saving image data captured with the optional camera-equipped microphone (MH-85A11U)
- Saving messages downloaded with the GM function or WIRES-X function
- Saving GPS log data

Usable microSD Memory Cards

This transceiver only supports the following capacity of microSD and microSDHD memory cards.

- 2GB • 4GB • 8GB • 16GB • 32GB



- microSD memory cards formatted on other devices may not properly save information when used with this transceiver. Format microSD memory cards again with this transceiver when using memory cards formatted with another device.
- Do not remove the microSD memory card or turn the transceiver Off, while saving data to a microSD memory card is in progress.

Mounting and Dismounting microSD Memory Card

1. Turn the transceiver **OFF**.
2. Insert a microSD memory card into the slot on the left side of the controller.

With the terminal surface of the microSD card facing the back of the controller, push it in gently until it clicks.

3. Turn the transceiver **ON**.
When the memory card is properly detected, “**SD**” lights on the display.

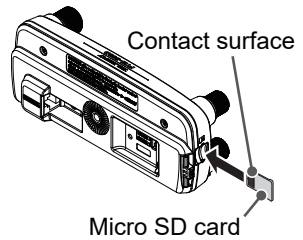

● Removing the microSD memory card

To remove the microSD memory card (inserted in step 2 above), push the memory card in until a clicking sound is heard, then remove the memory card.

Formatting a Micro SD Memory Card

Format a new microSD memory card following the steps below before use:



- A microSD memory card that was used in another device may not function properly, for example, it may not be recognized by the FTM-300DR/DE, or reading and writing may take an unusually long time. Use of the SD Memory Card Formatter provided by the SD Association may improve this. The SD Memory Card Formatter can be downloaded from this URL (<https://www.sdcard.org/downloads/formatter/index.html>).
- Formatting a microSD memory card erases all data saved on it. Before formatting the card, be sure to check for data and save it before formatting.

1. Press and hold the **[F(SETUP)]** key.
2. Rotate the **DIAL** knob to select Set-up menu **[SD CARD]**, then press the **DIAL** knob.
3. Rotate the **DIAL** knob to select **[3 FORMAT]**, then press the **DIAL** knob.
“FORMAT?” appears on the LCD.
4. Rotate the **DIAL** knob to select **[OK]**, then press the **DIAL** knob.
Initialization starts and “**Waiting**” appears.
5. When formatting is completed, a beep sounds and “**COMPLETED**” appears on the LCD.

Turning the Transceiver ON

1. Press and hold the Power (Lock) switch to turn the transceiver **ON**.
- **Turning the transceiver OFF**
Press and hold the Power (Lock) switch again to turn the transceiver OFF.

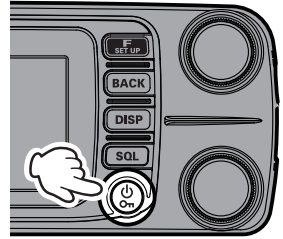

- **Inputting the call sign**

1. The first time the transceiver is turned ON after it is purchased; input your own call sign.
2. Press the **DIAL** knob to proceed to the call sign input screen.
 - When the transceiver is subsequently turned ON, the opening screen appears followed by the frequency screen.
 - The input call sign may be changed from the Setup Menu [CALLSIGN].
3. Rotate the **DIAL** knob to select a character and then press the **DIAL** knob.

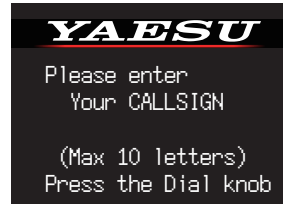

- ⬆️ : Moves the cursor to the right.
- ⬇️ : Moves the cursor to the left.
- 123 : Changes the numeric and symbol input.
- ✖️ : Deletes the character to left of the cursor.

i Up to 10 characters (letters, numbers, and a hyphen) can be entered.

4. Repeat step 3 to input the remaining call sign characters.
5. Press and hold the **DIAL** knob to conclude inputting.
Normal operation (VFO Mode) screen will be displayed.

Adjusting the volume

1. Rotate the **DIAL** knob to adjust the volume to a comfortable level.
Adjustment is possible for A band (upper) and B band (lower).

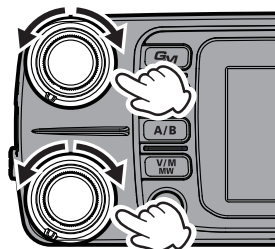

Adjusting the squelch level

Annoying noises can be muted when a signal cannot be detected. Normally, use the factory settings, but adjust the squelch if noise is harsh.

1. Press the **[SQL]** key, and then rotate the **DIAL** knob to adjust to a level at which the background noise is muted.

SQL  appears on the display.

Adjustment is possible for A band (upper) and B band (lower).

2. After the adjustment, press the **[SQL]** key again, or do nothing for about 3 seconds, the SQL meter will return to the VOL meter.

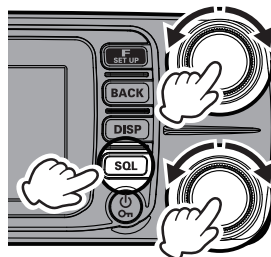

When the squelch level is increased, the noise is more likely to be silenced, but it may become more difficult to receive weak signals.

Changing the operation band

FTM-300DR/DE has two operating bands displayed in two frames, (top and bottom) and can receive both bands simultaneously. It can be changed by operating the frequency or communication mode of the band selected either up or down.



The band displayed with large white numbers is called the “operation band”, and the band that is not the operation band is called the “sub-band”.



The reception of the C4FM digital signal gives priority to the operation band side. A band and B band C4FM digital signals cannot be heard simultaneously.

1. Each time the **[A/B]** key is pressed, the operation band switches between “A band (upper)” and “B band (lower)”.

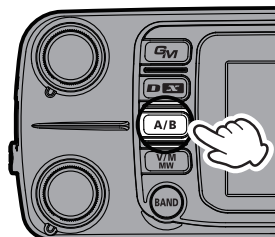

Selecting a Frequency Band

Press the **[BAND]** key to select the desired frequency band.

AIR Band	108MHz - 137MHz
144MHz Band	137MHz - 174MHz
VHF Band	174MHz - 400MHz
430MHz Band	400MHz - 480MHz
UHF Band	480MHz - 999.99MHz

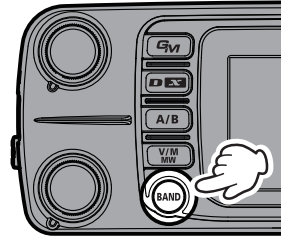

Tuning to a Frequency

● DIAL knob

Rotating the **DIAL** knob changes the frequency in the optimal frequency step for the current frequency band.

Change frequency in 1MHz steps

Press the **DIAL** knob, and then rotate the **DIAL** knob.

Change frequency in 5MHz steps

Press and hold the **DIAL** knob, and then rotate the **DIAL** knob.

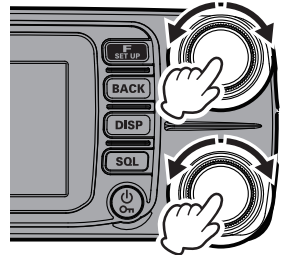

● Frequency input screen

1. In VFO mode, press the **[F(SETUP)]** key.
2. Rotate the **DIAL** knob to select **[ENTER FREQUENCY]**, then press the **DIAL** knob.
The frequency input screen appears.

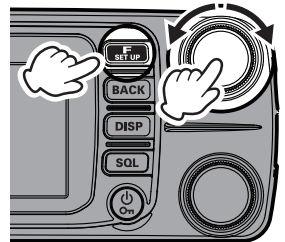

3. Rotate the **DIAL** knob to select a number and press the **DIAL** knob.
4. Repeat step 3 to input the remaining frequency characters.
5. Press and hold the **DIAL** knob to conclude inputting.

Pressing the **[F(SETUP)]** or **[BACK]** key while inputting the frequency cancels the input and returns to the function screen. Press any other key (except the power switch) to cancel the input and return to the operation screen.



● The numeric keys on microphone

Press the numeric keys "0" to "9" to enter the frequency.

Example: To input 145.520 MHz

[1] → [4] → [5] → [5] → [2]

Example: To input 430.000 MHz

[4] → [3] → [Press and hold any numeric key]

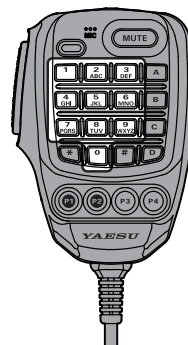

i While entering a frequency using the numeric keys, the entry may be canceled by pressing the PTT switch or the [BACK] key.

Changing the Frequency Step

The **DIAL** knob rotation frequency step may be changed. Normally, use the factory default setting of "AUTO".

1. Press and hold the [F(SETUP)] key.
2. Rotate the **DIAL** knob to select [CONFIG], then press the **DIAL** knob.
3. Rotate the **DIAL** knob to select [7 STEP], then press the **DIAL** knob.
4. Rotate the **DIAL** knob to set the frequency step.
5. Press the [DISP] key to complete the setting.

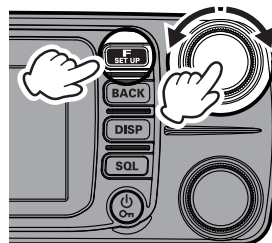

- i**
- The default setting, of the frequency step is set to "AUTO", which automatically provides a suitable frequency step according to the frequency band.
 - The frequency steps that can be selected depend on the frequency band.

Selecting the Communication Mode

● Using AMS (Automatic Mode Select) function

The FTM-300DR/DE transceiver is equipped with the AMS (Automatic Mode Select) function which automatically selects the communication mode corresponding to the received signal.

To utilize the AMS function, touch [D X] repeatedly to display “FM”*, “DN”* or “VW”* on the display. After receiving the signal, “FM” or “ ” will change to indicate the mode of the received signal.

*The display differs depending on the received signal.

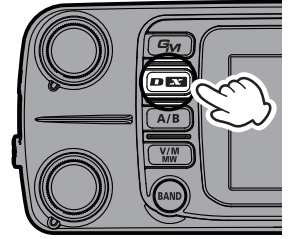

● Setting the transmit mode when using the AMS function

The AMS function will automatically set the receiver to the mode of the received signal, but the transmit mode may be fixed regardless of the received mode.

1. Press and hold the [F(SETUP)] key.
2. Rotate the **DIAL** knob to select [TX/RX], then press the **DIAL** knob.
3. Rotate the **DIAL** knob to select [2 DIGITAL], then press the **DIAL** knob.
4. Rotate the **DIAL** knob to select [1 AMS TX MODE], then press the **DIAL** knob.
5. Press the **DIAL** knob to select to the desired transmit mode as follows:

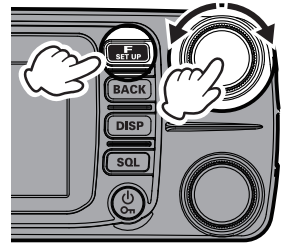

*The display differs depending on the transmit mode.

Transmit Mode	Receive and Transmit
AUTO (default)	<p>Receive: Automatically selects the receive mode corresponding to the received signal.</p> <p>Transmit: Automatically transmits in the communication mode selected by the AMS function.</p>
TX FM FIXED	<p>Receive: Automatically selects the receive mode corresponding to the received signal.</p> <p>Transmit: Always transmits in the analog FM mode.</p>
TX DN FIXED (TX DIGITAL)	<p>Receive: Automatically selects the receive mode corresponding to the received signal.</p> <p>Transmit: Always transmits in the DN mode.</p>

E2O-II (Easy to Operate-II) frequently used functions can be called with one touch

Press the [F(SETUP)] key to display a function menu that allows one-touch access to frequently used functions such as direct frequency input, memory recall, and signaling change.

To set other functions, call up the menu screen by pressing and holding the [F(SETUP)] key (see page 60).

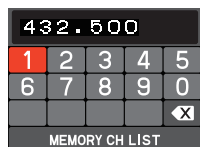

MEMORY CH LIST
DIRECT FREQUENCY INPUT/
MEMORY CH RECALL



APRS

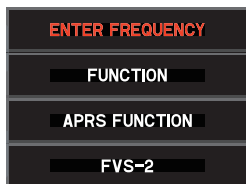

E2O-II FUNCTION MENU



SIGNALING



REC/PLAY

- **ENTER FREQUENCY (in VFO mode) / MEMORY CH (in MEMORY mode) in VFO mode:**

Enter the number directly to set the frequency (see page 23).

in MEMORY mode

Recall a memory channel by directly entering a number (see page 35).

In either VFO mode or MEMORY mode, select "MEMORY CH LIST" then press the DIAL knob to write or recall memory.

- **FUNCTION
REV**

The "reverse function" temporarily exchanges the transmit and receive frequencies (see page 32).

DTMF/DTMF MEMORY

Performs DTMF memory and recall.

LOG LIST

Play recorded audio (see page 55).

Display received messages.

Snapshot display (see page 57).

TXPWR

Change transmit power output (see page 28).

SQ TYP

Change squelch type (see page 5).

CODE/TONE

Change DCS code or CTCSS tone frequency.

REC

Perform operations related to audio recording (see page 53).

- **APRS FUNCTION
STN LIST**

Displays the station list.

MSG LIST

Displays the message list.

BEACON/BCN-TX

Set beacon transmission and beacon transmission manually.

- **FVS-2**
Perform voice recording and playback operations using the optional Voice Guide Unit FVS-2 (see page 5).

Fixing the Communication Mode

1. To fix the transmit operation mode, press the [D X] key to select the communication mode.

When the AMS function is OFF, the line above the mode icon disappears.

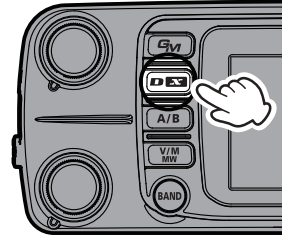

Communication Mode	Icon	Description of Modes
V/D mode (Voice & Data are transmitted simultaneously)		This is the standard digital mode. Calls are less prone to interruptions caused by detection and correction of the received digital voice signal.
Voice FR mode* ¹ (Voice Full Rate Mode)		High speed data communication using entire 12.5 kHz band. Enables high-quality voice communication.
FM mode		Analog communication using FM mode.
AM mode (receive only)* ²		The AM mode is for receive only.

*1 When the Set Mode [TX/RX] → [2 DIGITAL] → [5 DIGITAL VW] is set to “ON” (factory default is “OFF”), the Voice FR mode (VW) may be selected.

*2 When the Set Mode [TX/RX] → [1 MODE] → [2 RX MODE] is set to “AUTO” (factory default setting), AM mode is automatically selected within the AIR band (108 - 136.995 MHz).

The transceiver automatically switches to the Data FR mode (DW) mode during image transmission.

Transmitting

1. While pressing and holding the **PTT** switch, speak into the microphone.
2. Release the **PTT** switch to return to receive mode. When receiving a signal, the TX/BUSY Indicator lights according to the band of the received signal.

DIGITAL		ANALOG	
TX	RX	TX	RX
Red	Green	Red	Green
Blue	Blue	Red	Green



In digital mode, if a signal containing a DG-ID different from your own station is received, green (upper) and blue (lower) blink. Green (upper and lower) flashes when receiving a signal containing a tone signal or DCS different from your station in FM mode.



- If the PTT switch is pressed when a frequency other than the amateur ham radio band is selected, an alarm tone (beep) will be emitted and **“TX PROHIBIT”** appears on the display, disabling transmission.
- If transmission is continued for a long period, the transceiver overheats, and the high temperature protection function is activated. As a result, the transmitting power level is automatically set to Low Power. If transmission continues while the high temperature protection function is active, the transceiver will be forcibly returned to the receive mode.

Changing the Transmit Power Level

With the factory settings, the transmit power level changes from **“HI”** to **“LO”** to **“MD”** when the microphone [P4] key is pressed (see the table below). The transmit power level can also be changed using the function menu.

1. Press and hold the [F(SETUP)] key.
2. Rotate the **DIAL** knob to select [FUNCTION], then press the **DIAL** knob.
3. Rotate the **DIAL** knob to select [TXPWR].
4. The transmit power output switches as follows each time the **DIAL** knob is pressed.
“HI”→**“LO”**→**“MD”**
5. Press the [DISP] key to complete the setting.

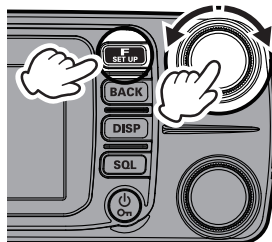

Display of PO meter during transmission

HI	MD	LO
50 W	25 W	5 W

*: The factory setting is **“HI”**.



The transmit power output can be set individually for each frequency band (band) and memory channel in each of A band and B band.

Locking the Keys and DIAL knob

1. Press the Power (Lock) switch, **“LOCK”** is shown on the display for one second, the icon appears on the display, and then the keys and **DIAL** knob are locked.

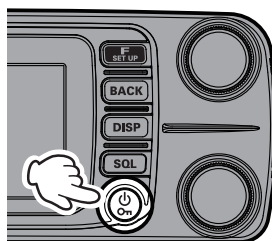

The PTT switch and the VOL knob cannot be locked.

Press the POWER (Lock) switch again, **“UNLOCK”** will be shown on the Display and the keys and the **DIAL** knob are unlocked.

The icon disappears.

Using the convenient Digital C4FM features

About the Digital Group ID (DG-ID) feature

Digital Group ID (DG-ID) function allows using the two-digit ID numbers to communicate only with specific group members. The desired DG-ID number from 00 to 99 is set in advance by all the group members. This ID number may be set separately for transmit and receive, when the same ID number is set for both transmit and receive, only group members with the same ID number will be heard. This feature may be used to limit communication only to group members that have the same DG-ID number. The GM function may also be utilized to automatically monitor whether or not group member stations with the same DG-ID number are operating within communication range.

The DG-ID number 00 detects signals with all ID numbers. Normally setting the ID number to "00" for both transmit and receive will permit reception of the signals from all other stations using the digital C4FM mode, regardless of the transmit DG-ID number settings of the other stations.

Also note that when the receive DG-ID number of the transceiver is set to a DG-ID number other than "00", received signals that do not have the same DG-ID number may not be heard.

2. When accessing a C4FM digital repeater controlled by a DG-ID number, set the transmit DG-ID number of the FTM-300DR/DE to that of the repeater input. Even in that case, if the receive DG-ID number of the FTM-300DR/DE is set to "00", all the downlink signals from the repeater may be received.

Communicating with the DG-ID feature



- Digital C4FM mode transceivers compatible with the DG-ID function are required in order to utilize this function.
- If the firmware is not compatible with the DG-ID function, update to the latest firmware to use the DG-ID function. The latest firmware is available on the YAESU website.

Setting the transmit and receive DG-ID number to "00" to communicate with all other stations using C4FM digital mode

1. Press and hold the **[GM]** key.

The DG-ID number setting screen will be displayed.



While setting the DG-ID number, pressing and holding the **DIAL** knob will set the transmit and the receive DG-ID numbers to "00".

2. If the transmit DG-ID (DG-ID TX) number is not set to "00", press the **DIAL** knob, and then rotate the **DIAL** knob to set "00".
3. Press the **DIAL** knob again, and rotate the **DIAL** knob to select the receive DG-ID (DG-ID RX).
4. If the receive DG-ID number is not set "00", press the **DIAL** knob, then rotate the **DIAL** knob to set "00".

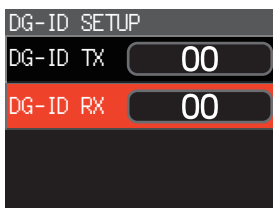
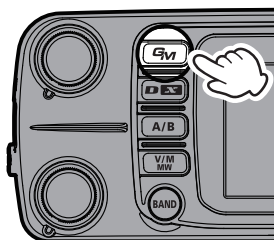

5. Press the **[DISP]** key to complete the setting.

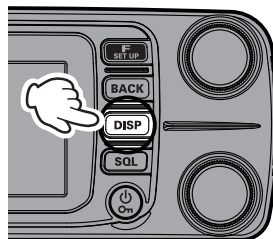

6. To check whether or not other stations are operating within communications range, press the **[GM]** key to turn the GM (Group Monitor) function ON.
 - The other stations must also have the GM (Group Monitor) function ON.
 - Refer to the separate Operating Manual GM Edition for details on how to use the GM function (download the manual from our YAESU website).
7. Press the **[GM]** key to turn the GM (Group Monitor) function OFF and return to normal operations.



- If the receive DG-ID is set to a number other than “00”, only signals with that DG-ID will be received. Normally, set the receive DG-ID number to “00” except when communication is desired only with group members.
- The transmit and receive DG-ID default number is set to “00”.

Communicate only with the specific members by setting the DG-ID number except for “00”

Example: Set the DG-ID number of to “50”

1. Press and hold the **[GM]** key.
The DG-ID number setting screen will be displayed.



While setting the DG-ID number, pressing and holding the **DIAL** knob will set the transmit and the receive DG-ID numbers to “00”.

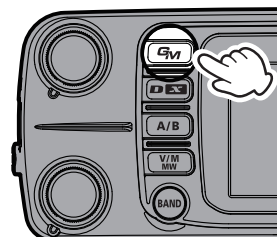

2. Press the **DIAL** knob, and then rotate the **DIAL** knob to set transmit DG-ID (DG-ID TX) number to “50”.
3. Press the **DIAL** knob again, then rotate the **DIAL** knob to select the receive DG-ID (DG-ID RX).

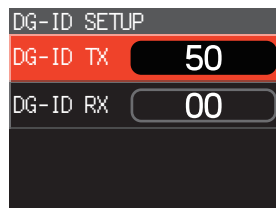

4. Press the **DIAL** knob, and then rotate the **DIAL** knob to set receive DG-ID (DG-ID RX) number to “50”.
5. Press the **[DISP]** key to complete the setting.
Tuning to the same frequency and setting the same DG-ID for all the group members will enable communication between the members and exclude other signals.

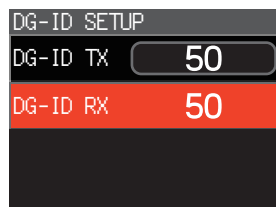

- Press the **[GM]** key to turn the GM (Group Monitor) function ON and check whether or not other stations that are operating on frequency, with the GM (Group Monitor) function ON, and have the same GD-ID number setting, are in the communication range.
- The other stations must also have the GM (Group Monitor) function ON.

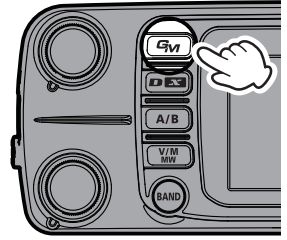

6. Press the **[GM]** key to turn the GM (Group Monitor) function OFF and return to the normal operation.

While operating in the GM function, the call sign and the signal strength of a maximum 24 stations with the GM function turned ON, and that are within the communication range, may be checked.



For details on how to set each item, refer to "FTM-300DR/DE GM Function Instruction Manual" which is available on the Yaesu website.

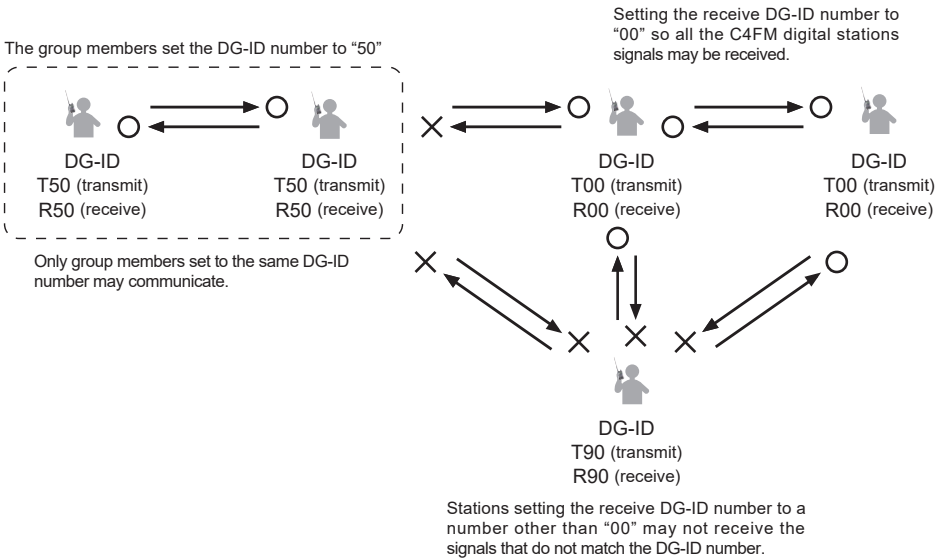

Repeater Operation

Communicating Via the Repeater

The transceiver includes an ARS (Automatic Repeater Shift) function which automatically sets the repeater operation when the receiver is tuned to the repeater frequency.

1. Set the receive frequency to the repeater frequency “-” or “+” appears on top of the display.
2. “-” or “+” and “TN” icons may automatically appear above the frequency.
3. Speak into the microphone while pressing and holding the PTT switch.

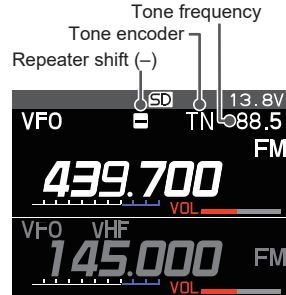

● Reverse function

The “reverse” state temporarily reverses the transmit and receive frequencies. This allows checking to find if direct communication with the other station is possible.

1. Press the **[F(SETUP)]** key.
2. Rotate the **DIAL** knob to select **[FUNCTION]**, then press the **DIAL** knob.
3. Rotate the **DIAL** knob to select **[REV]**, then press the **DIAL** knob.
 - The transmit and receive frequencies are temporarily reversed (“reverse” state).
 - In the “reverse” state, the “-” or “+” blinks on the display.
4. To release the reverse state, repeat the above steps again.

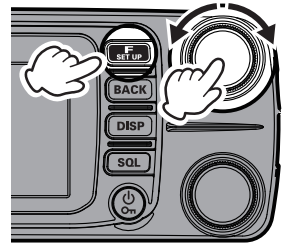

- The repeater settings may be changed from the Setup Menu.
 - Setup Menu **[CONFIG]** → **[4 RPT ARS]**: The ARS function may be set to OFF
 - Setup Menu **[CONFIG]** → **[5 RPT SHIFT]**: Allows setting the repeater shift direction.
 - Setup Menu **[CONFIG]** → **[6 RPT SHIFT FREQ]**: Allows changing the repeater shift offset.
- Function Menu **[FUNCTION]** → **[TONE]**: CTCSS Tone frequency

● Tone Calling (1750 Hz)

If your transceiver is FTM-300DE (European version), press and hold in the **[P4]** key on the microphone (in factory default setting) to generate a 1750 Hz burst tone to access the European repeater. The transmitter will automatically be activated, and a 1750 Hz audio tone will be superimposed on the carrier. Once access to the repeater has been gained, you may release the switch, and use the switch for activating the transmitter thereafter. If you need to access the repeaters which requires a 1750 Hz burst tone for access by the FTM-300DR (USA/Asian versions), you can set the program key on the microphone to serve as a “**T-CALL**” key instead. To change the configuration of this switch, use setup menu **[CONFIG]** → **[10 MIC PROGRAM KEY]**.

Using the Memory

The FTM-300DR/DE incorporates a Large number of memory channels that can register the operating frequency, communication mode, and other operational information.

- 999 Memory Channels
- 5 Home Channels
- 50 pairs PMS Memory Channels

The operating frequency and other operational information can be registered to each regular memory channel, home channel, or PMS memory channel:

- Operating frequency
- Transmitter output
- TX/RX DG-ID
- Memory channel skip information
- Communication Mode
- Memory tag
- Tone information
- Frequency Step
- Repeater Shift
- DCS information

NOTE

Back up the stored contents to a microSD memory card. For details on backing up to a microSD card.

Writing to memory (There are two ways)

(1) Press [V/M] key to write

1. Set the frequency to write to memory.
2. Press and hold the [V/M(MW)] key.

The memory channel list appears.

The lowest available number is selected. To select another channel, rotate the **DIAL** knob to select the memory channel number to be written.

- Rotate the lower **DIAL** knob to fast-forward in 10-channel steps.



For already written memory channels, the writing frequency is displayed.

3. Press and hold the [V/M (MW)] key or press the **DIAL** knob to display a popup. Make sure that [WRITE] is highlighted and press the **DIAL** knob.

If you attempt to register a frequency to a memory channel that already contains frequency data, "**OVERWRITE?**" will appear on the screen. Rotate the **DIAL** knob to select [OK], then press the **DIAL** knob to overwrite the memory channel.

4. The memory is stored, and the screen returns to the previous screen.

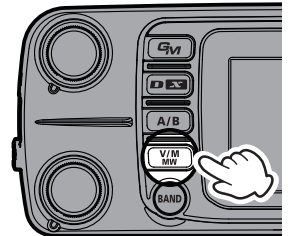

MEMORY CH LIST	
001	145.000
002	. ---
003	. ---
004	. ---

MEMORY CH LIST	
001	145.000
002	. ---
003	. ---
004	. ---

RECALL

WRITE

EDIT

DELETE

(2) Press the [F (SETUP)] key to write from the function menu

1. Set the frequency to write to memory.
2. Press the [F(SETUP)] key.
3. Rotate the **DIAL** knob, select [ENTER FREQUENCY] or [MEMORY CH], then press the **DIAL** knob to display the direct frequency input screen, or the memory channel number input screen.

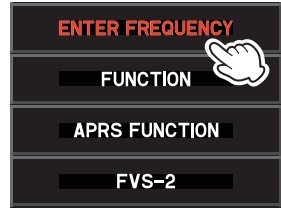

4. Rotate the **DIAL** knob to select [MEMORY CH LIST] then press the **DIAL** knob to display the memory channel list.
5. Subsequent operations are the same as those from step 3 above in "(1) Press the [V/M] key to write".

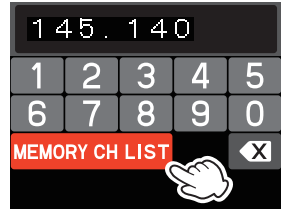

MEMORY CH LIST		
021	433.300	YAESU
022	433.620	FTM-300D
033	433.300	JA1YDE
041	433.100 433.200	DIGITAL

Recall memory (There are two ways)

(1) Press [V/M] key to recall

1. Press the [V/M(MW)] key.
The last used memory channel is recalled.
2. Rotate the **DIAL** knob to select the memory channel to recall.
3. Press the [V/M] key again to return to VFO mode.

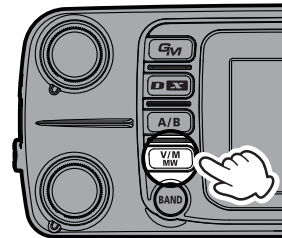

(2) Press the [F (SETUP)] key to recall from the function menu

1. Press the [F(SETUP)] key.
2. Rotate the **DIAL** knob, select [ENTER FREQUENCY] or [MEMORY CH], then press the **DIAL** knob to display the direct frequency input screen or the memory channel number input screen.
3. Rotate the **DIAL** knob to select [MEMORY CH] then press the **DIAL** knob to display the memory channel list.
4. Rotate the **DIAL** knob, select the memory channel to recall, then press the **DIAL** knob. A pop-up with [RECALL] highlighted appears. Press the **DIAL** knob. The selected memory channel will be recalled.

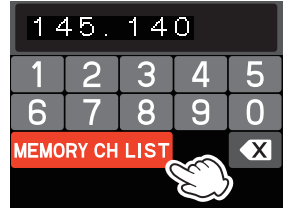
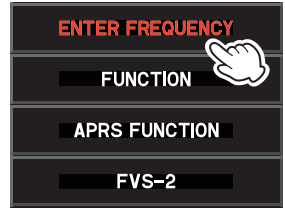

● Recalling a memory by directly entering the channel number

1. Press the [F (SETUP)] key in the memory mode.
2. Rotate the **DIAL** knob to select [MEMORY CH], then press the **DIAL** knob.
The memory channel input screen appears.
3. Rotate the **DIAL** knob to select a memory channel number, then press the **DIAL** knob.

(Example) When recalling memory channel "123".

Rotate the **DIAL** knob to select [1] → Press the **DIAL** knob



Rotate the **DIAL** knob to select [2] → Press the **DIAL** knob



Rotate the **DIAL** knob to select [3] → Press the **DIAL** knob

(Example) When recalling memory channel "16".

Rotate the **DIAL** knob to select [1] → Press the **DIAL** knob



Rotate the **DIAL** knob to select [6] → Press the **DIAL** knob



Press and hold the **DIAL** knob

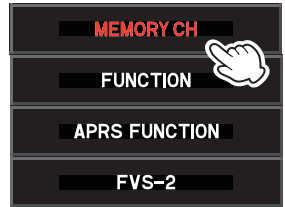

● **Recall a memory by directly inputting channels using the numeric keys on the microphone**

Press the numeric keys “0” to “9” in the memory mode to enter the memory channel.

(**Example**) When recalling memory channel “123”.

Press the [1] key.



Press the [2] key.



Press the [3] key.

(**Example**) When recalling memory channel “16”.

Press the [1] key.



Press the [6] key.



Press and hold any numeric key.

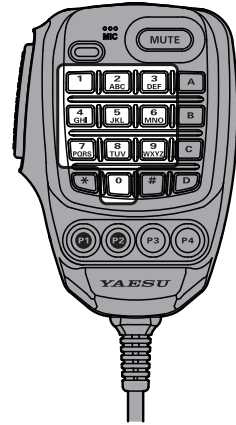

Press the **PTT** switch while entering a number to cancel the entry.

Displaying a list of memory channels in memory mode

Turning the **DIAL** knob in memory mode usually increases or decreases the memory channel number. Rotating the **DIAL** knob automatically displays the memory channel list and allows you to recall the desired memory channel while checking the contents of multiple memory channels.

1. Press and hold the [**F(SETUP)**] key.
2. Rotate the **DIAL** knob to select the [**MEMORY**], and then **DIAL** knob.
3. Press the **DIAL** knob to set [**1 MEMORY LIST**] to “**ON**”.
4. Press the [**DISP**] key to complete the setting.

To return to normal up / down operation, set “**OFF**” in step 3 of the above operation.

Recall only memories in the same frequency band (Band) using the memory auto grouping (MAG) function

With the memory auto grouping (MAG) function, only memory channels in the same frequency band (Band) can be called.

In the memory mode, each time the [BAND] key is pressed, only memory channels of the specified frequency band are automatically recalled as a group, as shown below:

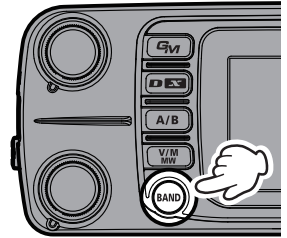

Group Name	Selectable Memory Channels
M-ALL	All memory channels.
M-AIR	AIR band memory channels only.
M-VHF	144 MHz band memory channels only.
M-UHF	430 MHz band memory channels only.
M-GEN	VHF and UHF band memory channels only.
M-GRP	Memory channels registered in advance regardless of the frequency band.

M-GRP allows you to create groups of memory channels regardless of frequency.

● Registering memory in M-GRP (memory group)

1. Press the [F(SETUP)] key.
2. Rotate the **DIAL** knob to select [ENTER FREQUENCY] or [MEMORY CH], then press the **DIAL** knob.
3. Rotate the **DIAL** knob to select [MEMORY CH LIST], then press the **DIAL** knob.
The memory channel list appears.
4. Rotate the **DIAL** knob to select the memory channel you want to register in **M-GRP**.
5. Press and hold the [BAND] key to register that memory channel in **M-GRP**.
 - The memory channel numbers registered in **M-GRP** are displayed in blue.
 - To register another channel, repeat steps 1 and 2.
 - To delete the registration, select the memory channel then press and hold the [BAND] key to cancel the registration.
6. Press the [DISP] key to complete registration.

● Deleting memory from M-GRP (memory group)

To delete a memory channel from M-GRP, perform procedures 1 to 6 as above; proceed to step 4 and select the memory channel to delete. In step 5, press and hold the [BAND] key to cancel the registration.

Multi Channel Standby (MCS) Function

Convenient function to automatically watch multiple memory channels registered in the **MAG** function group.

Example: Operate MCS function with M-GRP

1. In the memory mode, press the [BAND] key to select **M-GRP**.
2. Press and hold the [BAND] key.
 - Watch all memory channels registered in **M-GRP**.
 - When the **MCS** is active, “**MCS**” appears on the display.
 - When a signal is received, watch stops on the received memory channel and the audio can be heard.
 - Watch stops on that channel until 5 seconds after reception is completed, so you can communicate.
 - When there is no transmit or receive operation for about 5 seconds, the watch of the memory channels registered in **M-GRP** is started again.
3. To cancel the **MCS** function, press the [BAND] key.

Edit memory

● Edit memory tag

Memory name tags, such as a call sign or broadcast station name may be assigned to the memory channels and home channels. Input a memory tag using up to 16 characters. Alphabetic characters (upper and lowercase), Numbers and Symbols may be entered to the memory name tag.

1. Press the **[F(SETUP)]** key.
2. Rotate the **DIAL** knob to select **[ENTER FREQUENCY]** or **[MEMORY CH]**, then press the **DIAL** knob.

The frequency input screen or memory channel input screen appears.

3. Rotate the **DIAL** knob to select **[MEMORY CH LIST]**, then press the **DIAL** knob.

The memory channel list appears.

4. Rotate the **DIAL** knob to select the memory channel for editing the memory tag, then press the **DIAL** knob.

5. A popup will appear. Rotate the **DIAL** knob to select **[EDIT]** then press the **DIAL** knob.

The memory information appears.

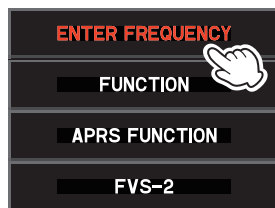

MEMORY CH LIST		
021	433.300	YAESU
022	433.620	FTM-300D
033	433.300	JA1YDE
041	433.100 433.200	DIGITAL

MEMORY CH LIST		
021	433.300	YAESU
022	433.620	FTM-300D
033	433.300	JA1YDE
041	433.100 433.200	DIGITAL

Below the table, a popup menu is shown with the following options: 'RECALL', 'WRITE', 'EDIT' (highlighted in red), and 'DELETE'.

6. Rotate the **DIAL** knob to select **[TAG]**, then press the **DIAL** knob.

- The character input screen is displayed. Rotate the **DIAL** knob to select a character, and press the **DIAL** knob to enter the character.

 : moves the cursor to the left.

 : moves the cursor to the right.

 : displays the alphabet keypad input screen.

 : displays the numeric keypad input screen.

 : displays the symbols keypad input screen.

 : erases the character to the left of the cursor and moves the cursor to the left.

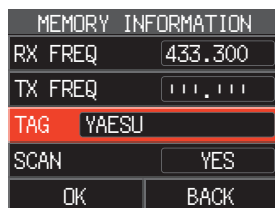

- See “Text input screen” on page 71 to input a memory tag.

7. When input is complete, press and hold the **DIAL** knob to save the characters and return to “**MEMORY INFORMATION**” screen.

8. Rotate the **DIAL** knob to select **[OK]**, then press the **DIAL** knob.

9. A confirmation pop-up appears. Select **[OK]** then press the **DIAL** knob to complete the memory tag entry.



The Memory tag is only displayed on the operating band.

● Clearing Memories

1. Press the **[F(SETUP)]** key.
2. Rotate the **DIAL** knob to select **[ENTER FREQUENCY]** or **[MEMORY CH]**, then press the **DIAL** knob.
The frequency input screen or memory channel input screen appears.
3. Rotate the **DIAL** knob to select **[MEMORY CH LIST]**, then press the **DIAL** knob.
The memory channel list appears.
4. Rotate the **DIAL** knob to select the memory channel from which the data is to be cleared, and press the **DIAL** knob.
5. A pop-up appears. Rotate the **DIAL** knob to select **[DELETE]** then press the **DIAL** knob.
Confirmation screen “**DELETE?**” is displayed.
Rotate the **DIAL** knob to select **[OK]**, then press the **DIAL** knob.

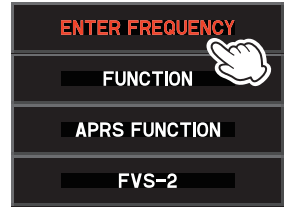

Data on memory channel One, and the Home channel may not be cleared.

Recalling the Home Channels

1. Press the **[P2]*** key on the microphone.

* This is the factory setting. This function can also be assigned to the **[P3]** or **[P4]** key (see page 9).

“**HOME**” and the home channel frequency of the currently selected band appears on the LCD.

2. Press the **[P2]** key again, to return to the previous frequency.

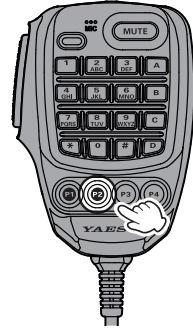

While recalling the home channel, rotate the **DIAL** knob to transfer the home channel frequency to the operating band VFO.

Changing the Home Channel Frequency

1. Set the frequency and the operating mode to be stored as a home channel.
2. Press the **[F(SETUP)]** key.

Or press and hold the **[V/M(MW)]** key and proceed to step 5.

3. Rotate the **DIAL** knob to select **[ENTER FREQUENCY]** or **[MEMORY CH]**, then press the **DIAL** knob.

The frequency input screen or memory channel input screen appears.

4. Rotate the **DIAL** knob to select **[MEMORY CH LIST]**, then press the **DIAL** knob.

The memory channel list appears.

5. Rotate the **DIAL** knob to select **[HOM]** displayed at the top of the memory channel list.

6. Press and hold the **[V/M(MW)]** key or press the **DIAL** knob to display a popup. Make sure that **[WRITE]** is highlighted and press the **DIAL** knob.

Confirmation screen “**OVER WRITE?**” is displayed.

7. Rotate the **DIAL** knob to select **[OK]**, then press the **DIAL** knob.

8. The contents of the home channel are changed and the previous screen returns.

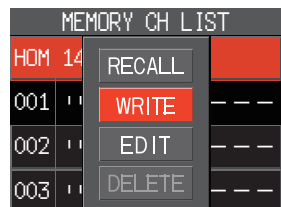
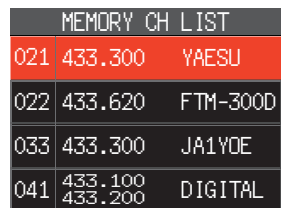
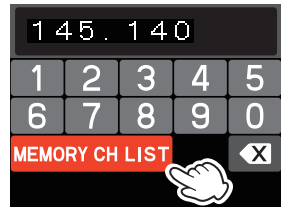
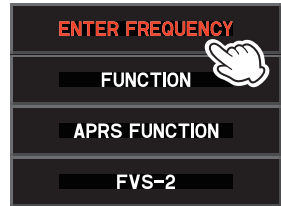

Split Memory

Two different frequencies, one for receive and another for transmit, can be registered to a memory channel.

1. Register the receive frequency to a memory channel first.

For additional details on registering to a memory channel, refer to the “Writing to memory” (page 33).

To edit a memory channel that has already been written, go to step 2.

2. Press and hold the **[V/M(MW)]** key.
The memory channel list appears.
3. Rotate the **DIAL** knob to select the channel number that the receive frequency was registered to on step 1, and press the **DIAL** knob.
4. Rotate the **DIAL** knob to select **[EDIT]**, then press the **DIAL** knob.
5. Rotate the **DIAL** knob to select **[TX FREQ]**, then press the **DIAL** knob.

6. Set the transceiver to the desired transmit frequency.
7. Rotate the **DIAL** knob to select **[OK]**, then press the **DIAL** knob.

8. Confirmation screen is displayed, press the **DIAL** knob.
The display returns to the memory channel list screen, and the receive frequency is displayed on the upper side, and the transmit frequency is displayed on the lower side.

9. Press the **[DISP]** key to complete the setting.
When recalling the split memory “**[E]**” is displayed on the LCD.



While operating the split memory, to reverse the transmit and receive frequencies temporarily:

[F(SETUP)] → **[FUNCTION]** → **[REV]**

When reversing the frequencies, “**[E]**” will blink.

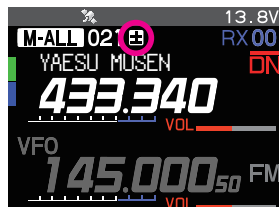
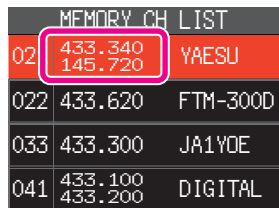
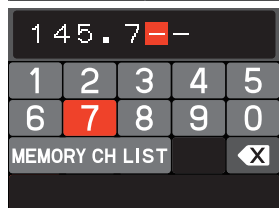
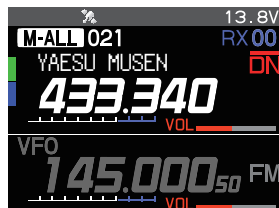

Scanning Function

The **FTM-300DR/DE** supports the following three scanning functions:

- VFO Scan
- Memory Channel Scan
- Programmable Memory Scan (PMS)

VFO Scan/Memory Scan

To find frequencies where there are signals in VFO mode or memory mode:

1. Press the **[A/B]** key to set the band to be scanned as the operation band.
2. Press the **[V/M(MW)]** key to switch to VFO mode or memory mode.
3. Press and hold the microphone **[UP]** or **[DWN]** switch to start scanning.
 - If the **DIAL** knob is rotated while scanning is in progress, the scanning will continue up or down in frequency according to the direction of the **DIAL** Knob rotation.
 - When a signal is received, the scan pauses, the frequency flashes, and the scan starts again after about 3 seconds.
4. Press the **PTT** switch or **[UP]** or **[DWN]** on the microphone to cancel the scanning.

The transceiver will not transmit in this case.

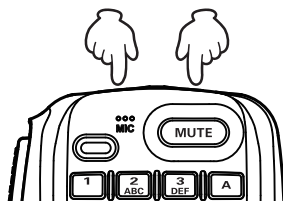
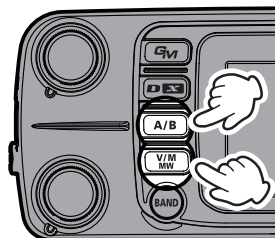

- If the scan has paused on a signal, rotating the **DIAL** knob will cause scanning to resume instantly.
- If the transceiver is turned OFF while scanning, when the transceiver is turned ON, scanning will resume.

Programmable Memory scan (PMS)

This function scans only the range of frequencies between the lower and upper limits registered in a pair of PMS Programmable Memory channels. 50 sets of PMS memory channels (L01/U01 to L50/U50) are available.



For additional details on the Programmable Memory Scan (PMS) and Memory Bank Scan, refer to the Advanced Manual which may be downloaded from the Yaesu website.

Setting the Receive Operation When Scanning Stops

1. Press and hold the **[F(SETUP)]** key.
2. Rotate the **DIAL** knob to select **[SCAN]**, then press the **DIAL** knob.
3. Press the **DIAL** knob to select the hold time after the scan is paused:
 - **1 sec / 3 sec / 5 sec**
The signal is received for a specified period of time, and then scanning resumes.
 - **BUSY**
The signal is received until the signal fades out. Two seconds after the signal fades out, scanning resumes.
 - **HOLD**
Scanning stops and tuning remains on the current receive frequency (Scanning does not resume).
4. Press the **[DISP]** key to save the new setting and exit to normal operation.

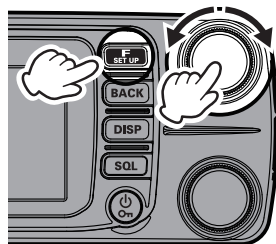

The above setting is common for all scanning operation.

Skip Memory Channels

Each memory channel can be set to be skipped during memory scan.

1. Press and hold the **[V/M(MW)]** key.
The memory channel list appears.

The memory channel list can also be displayed by the following operations.



1. press the **[F(SETUP)]** key → select **[ENTER FREQUENCY]** or **[MEMORY CH]**, then press the **DIAL** knob.
2. Rotate the **DIAL** knob to select **[MEMORY CH LIST]**.
3. Press the **DIAL** knob to show the memory channel list.

4. Rotate the **DIAL** knob to select the memory channel number that you do not want to scan, and press the **DIAL** knob.
5. Rotate the **DIAL** knob to select **[EDIT]**, then press the **DIAL** knob.
6. Rotate the **DIAL** knob to select **[SCAN]**.
7. Rotate the **DIAL** knob to select **[NO]**.
8. Rotate the **DIAL** knob to select **[OK]**, then press the **DIAL** knob.
9. When the confirmation screen is displayed, press the **DIAL** knob.
10. Press the **[DISP]** key or the **PTT** switch to complete the setting.
When the memory channel set as the skip memory is called, the “**✕**” icon is displayed.

Convenience Features

Bluetooth® Operation

The **FTM-300DR/DE** has built-in **Bluetooth®** functionality. Hands-free operation is possible using the optional **Bluetooth®** headset (**SSM-BT10**) or a commercially available **Bluetooth®** headset.



- The operation of all commercially available **Bluetooth®** headsets cannot be guaranteed.
- The **Bluetooth®** headset **SSM-BT10** can be charged by connecting to the DATA jac (see page 6) on the right side of the panel using the optional charging cable **SCU-41**.

Pairing the Bluetooth® Headset

When using the **Bluetooth®** Headset for the first time, the **Bluetooth®** Headset and the **FTM-300DR/DE** must be paired.

This step is only necessary when first connecting the headset.

1. To start the **Bluetooth®** headset in pairing mode.

SSM-BT10: Press and hold the **Multi-Function Button** for 3 seconds, until the **SSM-BT10** LED blinks red/blue alternately.

Press and hold the Multi Function Button for 3 seconds to turn ON.



2. Press and hold the **[F(SETUP)]** key.
3. Rotate the **DIAL** knob to select **[OPTION]**, then press the **DIAL** knob.

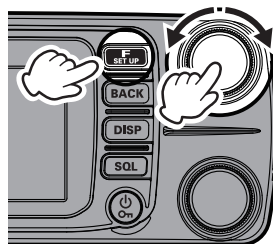

4. Rotate the **DIAL** knob to select **[2 Bluetooth]**, then press the **DIAL** knob.

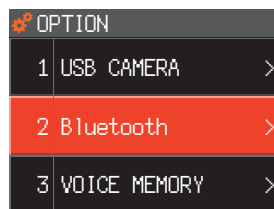

5. Press the **DIAL** knob and set **[Bluetooth]** to "ON".
The setting items are displayed.
6. Rotate the **DIAL** knob to select **[DEVICE]**, then press the **DIAL** knob.

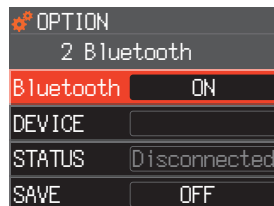

7. Press the **DIAL** knob.
The search starts, and the model name of the found **Bluetooth**® device is displayed in the list.
8. When the headset to be connected is displayed, press the [**BACK**] key to stop searching.



9. Rotate the **DIAL** knob to select the **Bluetooth**® headset to be connected.
10. Press the [**F(SETUP)**] key, then press the **DIAL** knob.

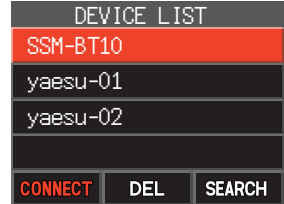

- When the connection is complete, the [**DEVICE**] field will display “Name of the connected **Bluetooth**® headset” and the [**STATUS**] field will display “Connected”.
- The LED of **SSM-BT10** blinks blue. The pairing is completed.

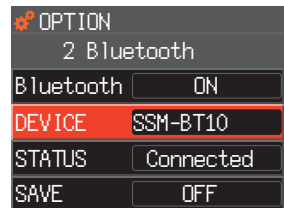

11. Press the [**DISP**] key to return to the normal operation.
While connected to a **Bluetooth**® headset, the “” icon lights up on the **FTM-300DR/DE** screen, and the received audio and operation beep will be heard from the **Bluetooth**® headset.

● **Disable the Bluetooth® function**

To cancel the **Bluetooth**® operation, just repeat the above procedures, selecting “**OFF**” in step 5 above.

● **Subsequent Bluetooth® headset connection when the power is turned ON**

- When the power is turned **OFF** while the **Bluetooth**® headset is connected, the next time the power is turned **ON**, the same **Bluetooth**® headset is searched for and automatically connected when found.
- If the **Bluetooth**® headset cannot be found, the “” icon blinks on the screen. If the power of the same **Bluetooth**® headset is turned **ON** in this state, it will connect automatically. If not, turn the **FTM-300DR/DE** and **Bluetooth**® headset **OFF** and then **ON** again.
- To connect to other **Bluetooth**® headsets, refer to “Connect with another **Bluetooth**® headset” on page 50.

Transmit operation by pressing the button on the Bluetooth® headset (when the VOX function is OFF)

When the **VOX** function is **OFF**, pressing the “Call button”* on the **Bluetooth®** headset once will engage the **FTM-300DR/DE** in transmit, and then a call can be made using the **Bluetooth®** headset.

Press the “Call button”* again to return the **FTM-300DR/DE** to receive.

*The button name may differ depending on your **Bluetooth®** headset.

SSM-BT10: When the **Multi-Function** Key is pressed, a beep will sound and the **FTM-300DR/DE** will continuously transmit.

Press the **Multi-Function** Key again, a beep will sound and the **FTM-300DR/DE** will return to receive mode.

Press briefly to transmit



Hands-free VOX operation with a Bluetooth® headset

When **FTM-300DR/DE VOX** (automatic voice transmission) function is turned **ON**, the **Bluetooth®** headset can perform hands-free operation and transmit automatically just by talking. Turn the VOX function **ON** according to “VOX Operation” instructions.



The VOX function is commonly used for the **Bluetooth®** headset and microphone. If you do not use the Bluetooth headset and do not want to use the **VOX** function with the microphone, set this to “**OFF**”.

VOX Operation

Using a **Bluetooth®** headset, you can transmit hands-free automatically, just by speaking into the microphone.



The VOX function does not activate with the optional camera-equipped microphone **MH-85A11U**.

Setting VOX function

1. Press and hold the **[F(SETUP)]** key.
2. Rotate the **DIAL** knob to select **[TX/RX]**, then press the **DIAL** knob.
3. Rotate the **DIAL** knob to select **[3 AUDIO]**, then press the **DIAL** knob.
4. Rotate the **DIAL** knob to select **[3 VOX]**, then press the **DIAL** knob.
5. Rotate the **DIAL** knob to select **[VOX]**, then press the **DIAL** knob.

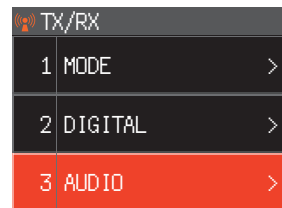
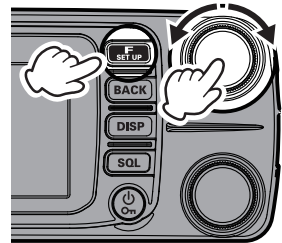

6. Rotate the **DIAL** knob to select “**LOW**” or “**HIGH**”.

OFF : **VOX** function **OFF**

LOW : **VOX** function **ON** (**VOX** Gain Level “**LOW**”)

HIGH : **VOX** function **ON** (**VOX** Gain Level “**HIGH**”)

When set to “**LOW**” or “**HIGH**”, the sound is automatically transmitted by voice from the connected **Bluetooth®** headset. When not connected to a **Bluetooth®** headset, the sound from the microphone is automatically transmitted.

7. Press the [**DISP**] key to complete the setting.

● **Disable the VOX function**

To cancel **VOX** and return to **PTT** operation, just repeat the above procedures, selecting “**OFF**” in step 6 above.

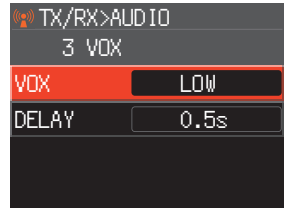

Set the VOX (Voice Operated Transmit) delay time

During transmissions using the **VOX** (Voice Operated Transmit) function, set the time to return to receive when speaking is paused:

1. Press and hold the [**F(SETUP)**] key.
2. Rotate the **DIAL** knob to select [**TX/RX**], then press the **DIAL** knob.
3. Rotate the **DIAL** knob to select [**3 AUDIO**], then press the **DIAL** knob.
4. Rotate the **DIAL** knob to select [**3 VOX**], then press the **DIAL** knob.
5. Rotate the **DIAL** knob to select [**DELAY**], then press the **DIAL** knob.
6. Rotate the **DIAL** knob to select the delay time (the transmit-receive delay after the cessation of speech).
0.5sec / 1.0sec / 1.5sec / 2.0sec / 2.5sec / 3.0sec
Factory default value: “0.5sec”.
7. Press the [**DISP**] key to complete the setting.

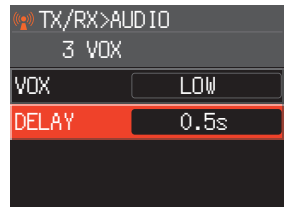
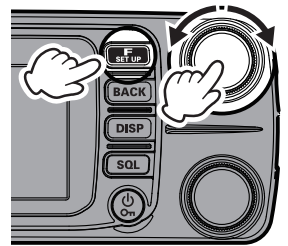

Bluetooth® battery save function

Turning on the **Bluetooth®** Battery Saver feature extends the battery life of the standby **Bluetooth®** headset.

1. Press and hold the **[F(SETUP)]** key.
2. Rotate the **DIAL** knob to select **[OPTION]**, then press the **DIAL** knob.
3. Rotate the **DIAL** knob to select **[2 Bluetooth]**, then press the **DIAL** knob.
4. Rotate the **DIAL** knob to select **[SAVE]**, then press the **DIAL** knob to select **"ON"**.
5. Press the **[DISP]** key to complete the setting.

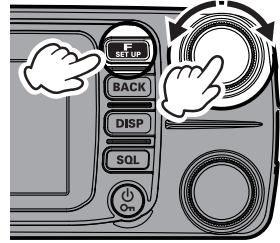

OPTION	
2 Bluetooth	
Bluetooth	ON
SAVE	SSM-BT10
STATUS	Connected
SAVE	ON

● Disable the battery save function

To cancel **Bluetooth®** Battery Saver feature, just repeat the above procedures, selecting **"OFF"** in step 4 above.

Connect with another Bluetooth® headset

1. Press and hold the **[F(SETUP)]** key.
2. Rotate the **DIAL** knob to select **[OPTION]**, then press the **DIAL** knob.
3. Rotate the **DIAL** knob to select **[2 Bluetooth]**, then press the **DIAL** knob.
4. If the **[STATUS]** field shows **"Connected"**, rotate the **DIAL** knob to select **[STATUS]** then press the **DIAL** knob.
"Disconnected" is displayed in the **[STATUS]** field.

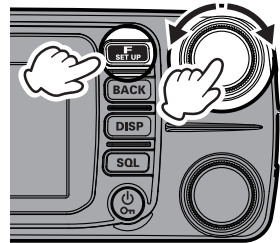

OPTION	
2 Bluetooth	
Bluetooth	ON
DEVICE	SSM-BT10
STATUS	Disconnected
SAVE	OFF

5. Rotate the **DIAL** knob to select [**DEVICE**], then press the **DIAL** knob.
6. Press the [**F(SETUP)**] key.
7. Rotate the **DIAL** knob to select [**SEARCH**], then press the **DIAL** knob.
8. Search **Bluetooth**® devices to display them in the device list in the following order:
 - (1) Already registered, searched and found **Bluetooth**® devices: white letters
 - (2) Searched and found new **Bluetooth**® devices: white letters
 - (3) Already registered but not found by search **Bluetooth**® devices: gray letters
9. When the headset to be connected is displayed, press the [**BACK**] key to stop searching.
10. Rotate the **DIAL** knob to select the desired Bluetooth® device.
11. Press the [**F(SETUP)**] key.
12. Rotate the **DIAL** knob to select [**CONNECT**], then press the **DIAL** knob to connect.

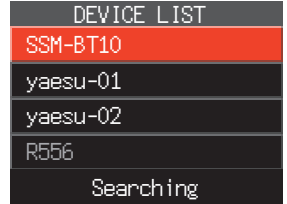

● **Connecting to a registered (paired) Bluetooth® headset**

1. Perform step 5 above to display the device list.
2. Rotate the **DIAL** knob to select a **Bluetooth**® headset to connect to.
3. Press the [**F(SETUP)**] key, then press the **DIAL** knob.
4. When the connection is completed, "**Connected**" is displayed in the STATUS column.

● **Remove a registered (paired) Bluetooth® device from the list**

1. In step 2 above, rotate the **DIAL** knob to select the **Bluetooth**® headset to be deleted.
2. Press the [**F(SETUP)**] key.
3. Rotate the **DIAL** knob to select [**DEL**], then press the **DIAL** knob. The **Bluetooth**® headset is deleted from the device list.

Band Scope

The **VFO** mode displays the current frequency as the center, and the memory mode displays the current memory channel as the center, and displays the signal status upper and lower channels with a **Band Scope**. The center frequency and memory channel can be changed by turning the **DIAL** knob.

Press the **[DISP]** key.

The band scope of the **VFO** currently used is displayed, and the received audio may be heard.

! While the Band Scope is displayed, the other **VFO** cannot be received.

VFO mode:

The status (strengths) of the signals in the upper and lower frequency channels (61CH) centered on the current receive frequency are displayed in the graph.

Memory Mode:

The status (strengths) of the signals in the upper and lower memory channels (21CH) centered on the current memory channel are displayed in the graph.

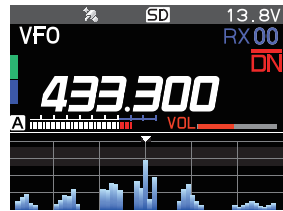
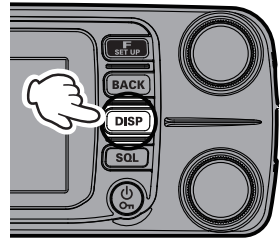

● Change frequency or Memory Channels

Rotate the **DIAL** knob to change the receive frequency or memory channel at the center of the band scope.

● Exit the Band Scope

Press the **[DISP]** key or the **[BACK]** key.

i The Band Scope frequency interval is the same as the **VFO** frequency step.

● Change the number of channels displayed

1. Press and hold the **[F(SETUP)]** key.
2. Rotate the **DIAL** knob to select **[DISPLAY]**, then press the **DIAL** knob.
3. Rotate the **DIAL** knob to select **[3 BAND SCOPE]**.
4. Press the **DIAL** knob to select **"WIDE"** or **"NARROW"**.

The number of channels displayed in each mode is as follows:

	WIDE	NARROW
VFO mode	61 channels	31 channels
Memory mode	21 channels	11 channels

Factory default value: **"WIDE"**.

5. Press the **[DISP]** key to complete the setting.

Using the Voice Recorder

With the voice recording function, the received audio of the other station, and/or the transmit audio of this unit is recorded on the MicroSD memory card. The recorded file can be played back with the **FTM-300DR/DE** or the MicroSD memory card can be taken out and used on a PC. Once recording is started, it continues until recording is stopped, or the capacity of the MicroSD card is full.

● About the file

- The audio file is saved in the “**VOICE**” folder on the MicroSD card.
- The file is a Wave sound format (extension: wav).
- The file name is “YYYYMMDDmmhhss.wav” (YYYY: year, MM: month, DD: day, hh: hour, mm: minute, ss: second) depending on the date and time when the recording started.

• When using the MicroSD memory card for the first time, please refer to “Formatting a MicroSD Memory Card” on page 20 for formatting.



• Since the date and time information is used for the voice recording function names and file timestamps when recording, it is recommended to set the date and time by following the procedure below:

[F(SETUP)] key → [CONFIG] → [1 DATE&TIME ADJUST]

Recording the receive audio

1. Press the [F(SETUP)] key, then rotate the **DIAL** knob to select [FUNCTION].
2. Press the **DIAL** knob.
3. Rotate the **DIAL** knob to select [REC].
4. Press the **DIAL** knob.
 - “**REC**” is displayed, and the recording function starts.
 - “**II**” is displayed at the top of the LCD and the unit enters the recording standby mode. When a signal is received, recording starts automatically.
 - During recording, the “**II**” indication changes to “**■**”.
 - With the factory default settings, the “**A-band**” received audio is recorded.
 - Recording will be paused about 3 seconds after the squelch of the band that is recording is closed. Recording will resume when a signal is received.
 - The band or bands to be recorded, and whether or not to include the transmit audio in the recording may be selected in the set mode.

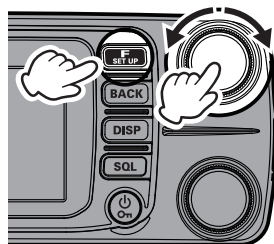

Recording is stopped when the transceiver is turned OFF.

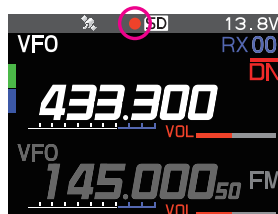

● Disable the recording function

1. Press the **[F(SETUP)]** key, then rotate the **DIAL** knob to select **[FUNCTION]**.
2. Press the **DIAL** knob.
3. Rotate the **DIAL** knob to select **[STOP]**, then press the **DIAL** knob.

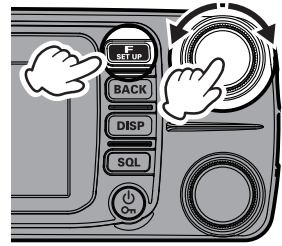

Setting the Recording function

The band or bands to be recorded, and whether or not to include the transmit audio in the recording may be selected:

1. Press and hold the **[F(SETUP)]** key.
2. Rotate the **DIAL** knob to select **[TX/RX]**, then press the **DIAL** knob.
3. Rotate the **DIAL** knob to select **[3 AUDIO]**, then press the **DIAL** knob.
4. Rotate the **DIAL** knob to select **[4 RECORDING]**, then press the **DIAL** knob.

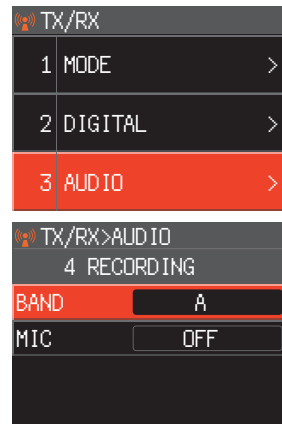
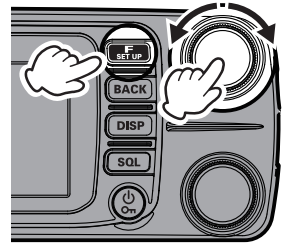

5. Rotate the **DIAL** knob to select **[BAND]**, then press the **DIAL** knob to select the band to record.
A : Record the A-band received audio
B : Record the B-band received audio
A+B : Record both A-band and B-band received audio

6. Rotate the **DIAL** knob to select **[MIC]**, then press the **DIAL** knob to select “**ON**” or “**OFF**”.
ON : Record both transmit and receive audio
OFF : Record only the receive audio

Playback the recorded audio



Playback is not possible during recording, so stop recording and follow the steps below to play back.

1. Press the **[F(SETUP)]** key, then rotate the **DIAL** knob to select **[FUNCTION]**.
2. Press the **DIAL** knob.
3. Rotate the **DIAL** knob to select **[LOG LIST]**, then press the **DIAL** knob.

REV	TXPWR HI
DTMF [00000]	SQ-TYP DCS
DTMF MEMORY	CODE 023
LOG LIST	REC

4. Rotate the **DIAL** knob to select **[VOICE]**.
5. Press the **DIAL** knob.
The recorded file will be displayed in a list.

LOG VOICE	
20200215140518	14:05
20200215122407	12:24
20200214183042	02/14
20200201151222	02/01
20200115120112	01/15
20191224102430	12/24

6. Rotate the **DIAL** knob to select the file to playback, then press the **DIAL** knob.
7. Press the **DIAL** knob.
 - Playback will begin
 - The receiver audio will not be heard during playback
 - Play back while recording is not possible.
 - Rotate the **DIAL** knob to select **[||]**, then press the **DIAL** knob to pause playback.
 - Rotate the **DIAL** knob to select **[◀◀]** or **[▶▶]**, then press the **DIAL** knob, to rewind or fast forward 5 seconds at a time.

LOG VOICE		
20200215140518	14:05	
20200215122407	12:24	
20200214183042	02/14	
20200201151222	02/01	
20200115120112	01/15	
DEL	TOP	☯

● Delete files

1. Rotate the **DIAL** knob in step 3 to select the file to be deleted, and then press the **[F(SETUP)]** key.
2. Rotate the **DIAL** knob to select **"DEL"**, then press the **DIAL** knob.
3. Rotate the **DIAL** knob to select **"OK"**, then press the **DIAL** knob.

VOICE PLAY		
2020215140518.wav		
00:44:34		
00:14:30		
◀		▶

Taking a Picture (Snapshot Function)

Pictures can be taken by connecting the optional camera-equipped microphone (**MH-85A11U**). Captured image data can be saved onto a **MicroSD** memory card inserted into the transceiver. The saved data can be displayed on the screen and transmitted to other transceivers* as well. In addition, the most recently captured image data can be transmitted to other transceivers* by pressing  (Send Image Button) on the camera-mounted microphone.

* Refer to the Yaesu website or catalog for the compatible transceiver models.

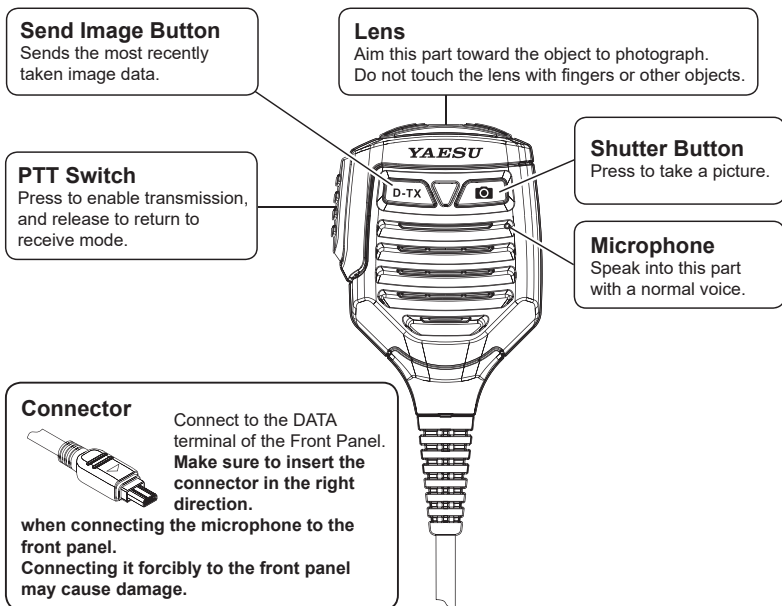

- Make sure to keep at least 50 cm distance between the lens and the object. If the object is too close, the picture will be out of focus, resulting in a blurred picture.
- You can set the size (resolution) and image quality (compression ratio) of the image to be shot by the following operations.
- Press and hold the **[F(SETUP)]** key → **[OPTION]** → **[1 USB CAMERA]**.
- If your station and the remote station are both in digital mode, you can transfer the image data most recently taken by pressing .
- Set the digital mode in advance to transfer images to other radios.
- Do not directly photograph objects with strong light, such as the sun or other bright objects. Doing so can cause malfunction.
- If the lens or the microphone gets dirty, use a dry, soft cloth to wipe off the contaminants.



Taking pictures

1. Turn the transceiver OFF.
2. Connect the camera-equipped microphone (**MH-85A11U**) to the **DATA** terminal of the front panel.
3. Point the camera lens at the object to be photographed and press the  (shutter button) on the microphone.
 - The captured image appears on the LCD.
 - Press the **[F(SETUP)]** key, to temporarily turn OFF the display of **[SAVE]** **[SEND]**

[EDIT] and view the entire photo. Press the [F(SETUP)] key again to display the [SAVE] [SEND] [EDIT].

4. To save the image onto the **MicroSD** memory card, rotate the **DIAL** knob to select [SAVE], then press the **DIAL** knob.

Press the [BACK] key to return the display to the previous operating screen without saving the image.

5. To transmit the saved image to other transceivers, press the  (Send Image Button) on the **MH-85A11U**.



Press the microphone **PTT** button to cancel the picture transmission (it may take a while for the transmission to be canceled).

6. Press the [BACK] key to return to the normal operation.

Viewing the Saved Image

1. Press the [F(SETUP)] key.
2. Rotate the **DIAL** knob to select [FUNCTION], then press the **DIAL** knob.
3. Rotate the **DIAL** knob to select [LOG LIST], then press the **DIAL** knob.
4. Rotate the **DIAL** knob to select [PICT], then press the **DIAL** knob.

Displays the saved image data list.

- Press the [F(SETUP)] key → Rotate the **DIAL** knob to select [↕] → Press the **DIAL** knob to display the end of the list.
 - Press the [F(SETUP)] key → Rotate the **DIAL** knob to select [TOP] → Press the **DIAL** knob to display the top of the list.
5. Rotate the **DIAL** knob to select the image to be displayed, then press the **DIAL** knob.
 - The image will be displayed.
 - Rotate the **DIAL** knob to display other saved images.
 - Press the **DIAL** knob while an image is displayed, you can temporarily turn off the display information other than the image, such as the file name, and view the entire photo. Press the **DIAL** knob again to display it again.
 6. Press the [F(SETUP)] key.
 7. Rotate the **DIAL** knob to select [SEND], then press the **DIAL** knob.

The confirmation screen will be displayed.
 8. Rotate the **DIAL** knob to select [OK], then press the **DIAL** knob.

Image transmission starts.
 9. Press the **PTT** switch to return to the normal screen.

Deleting saved images

1. Select [DEL] in step 7 above and press the **DIAL** knob.

The confirmation screen will be displayed.
2. Rotate the **DIAL** knob to select [OK], then press the **DIAL** knob.

The image is deleted.

GPS Function

The **FTM-300DR/DE** is equipped with a GPS (Global Positioning System) receiver. When receiving signals from GPS satellites, the current position (latitude, longitude, altitude) can be calculated and displayed within a tolerance of several meters. In addition, GPS receives the exact time from the satellite atomic clock.



Can be use the external GPS function by the following the procedure below:
Press and hold the **[F(SETUP)]** key → **[CONFIG]** → **[16 GPS DEVICE]** → “EXTERNAL”.

WIRES-X function

WIRES (Wide-coverage Internet Repeater Enhancement System) is an Internet communication system which expands the range of amateur radio communications by connecting with a local **WIRES-X** Node station. The **FTM-300DR/DE** can communicate and exchange data via the internet with **WIRES-X** nodes worldwide. Use the News Station function to write (upload) and read (download) digital data (text, images and audio). When connected to a **WIRES-X** node station or room, the node name, room name, call sign of the other station, distance, and direction, are all displayed on this screen.



For details, refer to the separate WIRES-X Instruction Manual which is available on the Yaesu website.

APRS (Automatic Packet Reporting System) function

The **FTM-300DR/DE** uses a GPS receiver to acquire and display its position location information. The **APRS** feature uses the location information to transmit the position information, data and messages, using the format developed by Bob Bruninga WB4APR. Upon receiving an APRS report from a remote station, the direction and distance to the remote station from your station, the speed of the remote station, and other data sent by the remote station may be displayed on the LCD of your transceiver. Setting several station parameters, such as the call sign and symbol is required before using the **APRS** function (initial settings).



For details, refer to the **APRS** Function Instruction Manual which is available on the Yaesu website.



For additional details on the following Functions, refer to the Advanced Manual which may be downloaded from the Yaesu website.

Tone squelch feature

The tone squelch opens the speaker audio only when a signal containing the specified **CTCSS** tone is received. By matching the **CTCSS** tone frequency with the partner stations, quiet standby monitoring is possible.

Digital Code squelch (DCS) feature

The **DCS** (Digital Coded Squelch) function allows audio to be heard only when signals containing the same **DCS** code are received.

New PAGER (EPCS) feature

This new feature allows calling specified stations only, by using a pager code that combines two **CTCSS** tones. Even when the person who is called is not near the transceiver, the information is displayed on the LCD to indicate that a call was received. When the call is received, the bell sounds.

Digital Personal ID (DP-ID) feature

Digital Personal ID (**DP-ID**) feature opens the speaker audio only when a **C4FM** signal set to the same **DP-ID** in the Digital Mode is received.

Using Setup Menu

The Set Mode permits configuring the various functions according to individual operating needs and preferences.

Setup Menu Operation

1. Press and hold the **[F(SETUP)]** key.
The SETUP MENU screen will be displayed.
2. Rotate the **DIAL** knob to select the desired item in the Setup Menu, then press the **DIAL** knob.
The Sub-menu screen will be displayed.

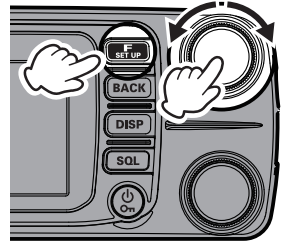

SETUP MENU		
DISPLAY	TX/RX	MEMORY
SIGNALING	SCAN	GM
WIRES-X	CONFIG	DATA
APRS	SD CARD	OPTION
RESET	CLONE	CALLSIGN

3. Rotate the **DIAL** knob to select the desired item to set.
“>” Is displayed at the right end of the submenu that has the deeper level of menu items.

DISPLAY
COMPASS
1 TARGET LOCATION
2 COMPASS
3 BAND SCOPE
4 LCD BRIGHTNESS

4. [When there is no deeper level of menu items].
Go step 6.
5. [When there is a deeper level of menu items]
Press the **DIAL** knob.
The Sub-menu screen will be displayed.
Rotate the **DIAL** knob to select the desired item to set, then press the **DIAL** knob.
6. There are the following two types of operations for changing the settings depending on the item.
 - (1) For items whose setting value frame at the top of the screen is displayed in red, the setting value changes each time the **DIAL** knob is pressed.

DISPLAY
COMPASS
1 TARGET LOCATION
2 COMPASS
3 BAND SCOPE
4 LCD BRIGHTNESS

- (2) For items whose setting value frame at the top of the screen is displayed in white, press the **DIAL** knob to turn the frame line red, then rotate the **DIAL** knob to change the setting value.

□ DISPLAY	
MAX	
1	TARGET LOCATION
2	COMPASS
3	BAND SCOPE
4	LCD BRIGHTNESS



□ DISPLAY	
MAX	
1	TARGET LOCATION
2	COMPASS
3	BAND SCOPE
4	LCD BRIGHTNESS

7. Press the **[DISP]** key or the **PTT** switch to save the settings and return to normal operation.

For some setting items, pressing the **PTT** switch does not return to the normal screen. In this case, press the **[BACK]** key to return to the upper layer, and then press the PTT switch.

Tables of Setup Menu Operations

Setup Menu no. / item	Description	Selectable options (Options in bold are the default settings)
DISPLAY		
1 TARGET LOCATION	Switch between the compass screen and the latitude and longitude display screen when using the GPS and GM functions	COMPASS / NUMERIC
2 COMPASS	Set the compass display of the smart navigation function	HEADING UP / NORTH UP
3 BAND SCOPE	Scope Display width setting	WIDE / NARROW
4 LCD BRIGHTNESS	Display and keys brightness	MIN / MID / MAX
5 SOFTWARE VERSION	Software version display	Main / Sub / DSP
6 DISPLAY MODE	Back Track, Altitude, Timer/Clock or GPS Information screen display.	BACKTRACK / ALTITUDE/ TIMER/CLOCK / GPS INFORMATION
TX/RX		
1 MODE		
1 FM BANDWIDTH	Set the FM transmission modulation level	WIDE / NARROW
2 RX MODE	Select the receive mode	AUTO / FM / AM
2 DIGITAL		
1 AMS TX MODE	Set the AMS transmission mode	AUTO / TX FM FIXED / TX DN FIXED
2 DIGITAL POPUP	Information screen popup time	OFF / 2 sec / 4 sec / 6 sec / 8 sec / 10 sec / 20 sec / 30 sec / 60 sec / CONTINUE
3 LOCATION SERVICE	Own (MY) position display setting in the digital mode	ON / OFF Refer to the separate Operating Manual GM Edition for details on the functions.
4 STANDBY BEEP	Standby Beep setting	ON / OFF
5 DIGITAL VW	Turn the VW mode selection ON or OFF	OFF / ON
3 AUDIO		
1 SUB BAND MUTE	Sub-band mute setting	OFF / ON
2 MIC GAIN	Microphone sensitivity setting	MIN / LOW / NORMAL / HIGH / MAX
3 VOX	VOX function setting	VOX: OFF / LOW / HIGH DELAY: 0.5s / 1.0s / 1.5s / 2.0s / 2.5s / 3.0s
4 RECORDING	Voice record function setting	BAND: A / B / A+B MIC: ON / OFF
MEMORY		
1 MEMORY LIST	Function to automatically display a list of memory channels in memory mode	OFF / ON
SIGNALING		
1 AUTO DIALER	DTMF code automatic transmit setting	OFF / ON

Setup Menu no. / item	Description	Selectable options (Options in bold are the default settings)
2 PAGER CODE	Pager individual code setting	RX CODE 1: 01 - 50 05 RX CODE 2: 01 - 50 47 TX CODE 1: 01 - 50 05 TX CODE 2: 01 - 50 47
3 PR FREQUENCY	User programmed reverse tone frequency	300Hz - 1500Hz - 3000Hz
4 BELL RINGER	Recall sound length setting	OFF / 1 time / 3 times / 5 times / 8 times / CONTINUOUS
5 SQL EXPANSION	Separate squelch type setting for transmit and receive	ON / OFF
6 WX ALERT	Weather alert operation setting	ON / OFF
SCAN		
1 SCAN RESUME	Set the resume operation after scanning stops on a signal	BUSY / HOLD / 1 sec / 3 sec / 5 sec
GM*		
* Refer to the separate Operating Manual GM Edition for details on the functions.		
1 DP-ID LIST	Displays the DP-ID list screen.	-
2 RANGE RINGER	Set the bell sound when checking for stations within sphere of communications	ON / OFF
3 RADIO ID CHECK	Specific transceiver ID is displayed	- (cannot be edited)
WIRES-X*		
* Refer to the separate Operating Manual WIRES-X Edition for details on the functions.		
1 RPT/WIRES FREQ	Set the repeater operating frequency / Register the WIRES-X preset frequency	MANUAL / PRESET Preset frequency: 146.550MHz 446.500MHz
2 SEARCH SETUP	Set the WIRES ROOM selection method	HISTORY / ACTIVITY
3 EDIT CATEGORYTAG	Edit the category tag	C1 to C5
4 REMOVE ROOM/NODE	Delete a registered category	C1 to C5
5 DG-ID	Set the DG-ID number for WIRES-X.	01 to 99 / AUTO
CONFIG		
1 DATE&TIME ADJUST	Set the date and time	-
2 DATE&TIME FORMAT	Set the date and time display formats	Date: yyyy/mmm/dd / dd/mmm/yyyy / yyyy/dd/mmm / mmm/dd/yyyy Time: 24 hour / 12 hour
3 TIME ZONE	Time zone setting	UTC -14:00 to ±0:00 to +14:00 UTC ±0:00
4 RPT ARS	Auto repeater shift setting	ON / OFF
5 RPT SHIFT	Repeater shift direction setting	OFF / - / +
6 RPT SHIFT FREQ	Repeater TX offset setting	0.00MHz to 99.95MHz
7 STEP	Channel step setting	AUTO / 5.0KHz / 6.25KHz / (8.33KHz) / 10.0KHz / 12.5KHz / 15.0KHz / 20.0KHz / 25.0KHz / 50.0KHz / 100KHz
8 BEEP	Beep setting	LOW / HIGH / OFF

Setup Menu no. / item	Description	Selectable options (Options in bold are the default settings)
9 CLOCK TYPE	Clock shift setting	A / B
10 MIC PROGRAM KEY	Microphone P2 / P3 / P4 buttons settings	OFF (disable the P button) / BAND SCOPE / SCAN / HOME / RPT SHIFT / REVERSE / TX POWER / SQL OFF / T-CALL / VOICE / D_X / WX / STN LIST / MSG LIST / REPLY / MSG EDIT P1: GM (FIX) P2: HOME P3: D_X P4: WX (T-CALL: European version)
11 RX COVERAGE	Reception range expansion setting	NORMAL / WIDE
12 UNIT	Display unit setting	METRIC / INCH (Depends on the transceiver version)
13 APO	Automatic power OFF time setting	OFF / 0.5 hour to 12.0 hour
14 TOT	TX time out setting	OFF / 1 min - 5 min - 30 min
15 GPS DATUM	GPS function positioning selection	WGS-84 / TOKYO MEAN
16 GPS DEVICE	GPS receiver selection	INTERNAL / EXTERNAL
17 GPS LOG	GPS access time setting	OFF / 1 sec / 2 sec / 5 sec / 10 sec / 30 sec / 60 sec
DATA		
1 COM PORT SETTING	COM port setting	SPEED: 4800 bps / 9600 bps / 19200 bps / 38400 bps / 57600 bps OUTPUT: OFF / GPS OUT / PACKET / WAYPOINT WP FORMAT: NMEA 6 / NMEA 7 / NMEA 8 / NMEA 9 WP FILTER: ALL / MOBILE / FREQUENCY / OBJECT/ITEM / DIGIPEATER / VoIP / WEATHER /YAESU / CALL RINGER / RANGE RINGER
2 DATA BAND SELECT	APRS/DATA band selection setting	APRS: MAIN BAND / SUB BAND / A-BAND FIX / B-BAND FIX / A=TX/B=RX / A=RX/B=TX DATA: MAIN BAND / SUB BAND / A-BAND FIX / B-BAND FIX / A=TX/B=RX / A=RX/B=TX
3 DATA SPEED	APRS/DATA communication baud rate setting	APRS: 1200 bps / 9600 bps DATA: 1200 bps / 9600 bps
4 DATA SQUELCH	Squelch detection setting	APRS: RX BAND / TX/RX BAND DATA: RX BAND / TX/RX BAND TX: ON / OFF
APRS*		
* Refer to the separate Operation Manual APRS Edition for details on the functions.		
1 APRS DESTINATION	Model code display Non-editable	APY300

Setup Menu no. / item	Description	Selectable options (Options in bold are the default settings)
2 APRS FILTER	Filter function setting	Mic-E: ON / OFF POSITION: ON / OFF WEATHER: ON / OFF OBJECT: ON / OFF ITEM: ON / OFF STATUS: ON / OFF OTHER: ON / OFF RANGE LIMIT: OFF / 1 / 10 / 100 / 1000 / 3000 ALTNET: ON / OFF
3 APRS MSG TEXT	Standard message text input	1 to 8 ch
4 APRS MODEM	APRS function ON/OFF setting	ON / OFF
5 APRS MUTE	Band B AF mute setting for APRS	ON / OFF
6 APRS POPUP	Pop-up time setting for display of beacons and messages	BEACON: OFF / 3 sec / 5 sec / 10 sec / HOLD MESSAGE: OFF / 3 sec / 5 sec / 10 sec / HOLD MYPACKET: OFF / ON
7 APRS RINGER	Set bell sound when beacon is received	TX BEACON: ON / OFF TX MESSAGE: ON / OFF RX BEACON: ON / OFF RX MESSAGE: ON / OFF MY PACKET: ON / OFF CALL RINGER: ON / OFF RANGE RINGER: OFF / 1 / 5 / 10 / 50 / 100 MSG VOICE: ON / OFF
8 APRS RINGER (CS)	Call sign setting for CALL RINGER	1 - 8 stations
9 APRS TX DELAY	Data transmit delay time setting	100 ms / 150 ms / 200 ms / 250 ms / 300 ms / 400 ms / 500 ms / 750 ms / 1000 ms
10 APRS UNITS	APRS display unit setting	POSITION: dd°mm.mm' / dd°mm'ss" DISTANCE: km / mile SPEED: km/h / mph / knot ALTITUDE: m / ft BARO: hPa / mb / mmHg / inHg TEMP: °C / °F RAIN: mm / inch WIND: m/s / mph / knot
11 BEACON INFO	Transmit beacon information setting	AMBIGUITY: OFF / 1 digit - 4 digits SPEED/COURSE: ON / OFF ALTITUDE: ON / OFF
12 BEACON STATUSTXT	Status text input setting	SELECT: TEXT 1 - 5 / OFF TX RATE: 1/1 - 1/8 / 1/2 (FREQ) - 1/8 (FREQ) TEXT 1 - 5: NONE / FREQUENCY / FREQ & SQL & SHIFT
13 BEACON TX	Beacon automatic transmit / Manual transmit switch	AUTO: OFF / ON INTERVAL: 30 sec - 5 min - 60 min PROPORTIONAL: ON / OFF DECAY: ON / OFF LOW SPEED: 1 - 3 - 99 RATE LIMIT: 5 sec - 30 sec - 180 sec

Setup Menu no. / item	Description	Selectable options (Options in bold are the default settings)
14 DIGI PATH	Digital repeater route setting	OFF / WIDE 1-1 / WIDE 1-1,WIDE 2-1 / PATH 1 - PATH 4 / FULL 1 / FULL 2
15 DIGI PATH 1	Digital repeater route address setting	ADDRESS 1: - ADDRESS 2: -
16 DIGI PATH 2		
17 DIGI PATH 3		
18 DIGI PATH 4		
19 DIGI PATH FULL 1		
20 DIGI PATH FULL 2	Digital repeater route address setting	ADDRESS 1: - ADDRESS 2: - ADDRESS 3: - ADDRESS 4: - ADDRESS 5: - ADDRESS 6: - ADDRESS 7: - ADDRESS 8: -
21 CALLSIGN (APRS)	My call sign setting	----- --
22 MESSAGE GROUP	Group filter setting for received messages	GROUP 1: ALL***** GROUP 2: CQ***** GROUP 3: QST***** GROUP 4: YAESU**** GROUP 5: - GROUP 6: - BULLETIN 1: BLN?***** BULLETIN 2: BLN? BULLETIN 3: BLN?
23 MESSAGE REPLY	Set automatic response to received messages	REPLY: OFF / ON CALLSIGN: *****_** REPLY TEXT: -
24 MY POSITION SET	My position setting	GPS / MANUAL
25 MY POSITION	My position manual setting	LAT: N 0°00. 00' (' 00") LON: E 0°00. 00' (' 00")
26 MY SYMBOL	My symbol setting	ICON 1: [/>] Car ICON 2: [/R] REC.Vehicle ICON 3: [/ -] House QTH (VHF) USER: [YY] Yaesu Radios
27 POSITION COMMENT	Set position comment	Off Duty / En Route / In Service / Returning / Committed / Special / Priority / Custom 0 - Custom 6 / EMERGENCY!
28 SmartBeaconing	Smart beaconing setting	STATUS: OFF / TYPE 1 / TYPE 2 / TYPE 3 LOW SPEED: 2 - 5 - 30 HIGH SPEED: 3 - 70 - 90 SLOW RATE: 1 - 30 min - 100 min FAST RATE: 10 - 120 sec - 180 sec TURN ANGLE: 5 - 28° - 90° TURN SLOPE: 1 - 26 - 255 TURN TIME: 5 - 30 sec - 180 sec

Setup Menu no. / item	Description	Selectable options (Options in bold are the default settings)
29 SORT FILTER	Sort function / Filter function setting	SORT: TIME / CALLSIGN / DISTANCE FILTER: ALL / MOBILE / FREQUENCY / OBJECT/ITEM / DIGIPEATER / VoIP / WEATHER / YAESU / OTHER PACKET / CALL RINGER / RANGE RINGER /1200 bps / 9600 bps
30 VOICE ALERT	Voice alert function setting	VOICE ALERT: NORMAL / TONE SQL DCS / RX-TSQL / RX-DCS TONE SQL: 67.0 Hz - 100.0 Hz - 254.1 Hz DCS: 023 - 754
SD CARD		
1 BACKUP	Reading and writing information of the radio to the MicroSD card	WRITE TO SD / READ FROM SD
2 MEMORY INFO	Displays the total capacity and free space of the MicroSD Card	-
3 FORMAT	Initializing the micro-SD card	-
OPTION		
1 USB CAMERA	Picture size / picture quality setting for the microphone with camera	
SIZE	Picture size setting	SIZE: 160×120 / 320×240
QUALITY	Picture quality setting	QUALITY: LOW / NORMAL / HIGH
2 Bluetooth	Bluetooth headset setting	OFF / ON
DEVICE	Bluetooth device list	-
STATUS	Display the connection status of Bluetooth devices	-
SAVE	Turn the Bluetooth save function ON or OFF	OFF / ON
3 VOICE MEMORY	Voice memory function setting	
PLAY/REC	Recording operation settings	FREE 5min / LAST 30sec
ANNOUNCE	Setting conditions for frequency announcement	AUTO / OFF / MANUAL
LANGUAGE	Setting the language to announce	ENGLISH / JAPANESE
VOLUME	Setting the announcement volume	HIGH / LOW / MID
RX MUTE	Setting to mute received sound during announcements and playback	ON / OFF
RESET		
1 FACTORY RESET	Return all settings to factory default	-
2 PRESET	Preset registration	-
3 RECALL PRESET	Recall preset	-

Setup Menu no. / item	Description	Selectable options (Options in bold are the default settings)
4 MEMORY CH RESET	Erase registered memory channels	-
5 APRS RESET	Return APRS settings to default settings when shipped	-
CLONE		
1 This → Other	Copy all saved data	This radio → other
2 Other → This		Other → This radio
CALLSIGN		
CALLSIGN	My call sign setting	*****

Restoring to Defaults (Reset)

Caution

When the All Reset function is performed, all data registered in the memory will be deleted. Be sure to note the settings on paper or back up the data on a microSD memory card.

All Reset

To restore all transceiver settings and memory content to the factory defaults.

1. Press and hold the **[F(SETUP)]** key.
The SETUP MENU screen will be displayed.
2. Rotate the **DIAL** knob to select **[RESET]**, then press the **DIAL** knob.

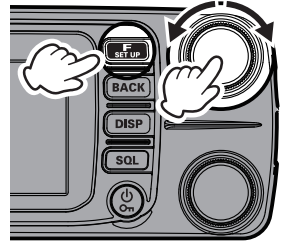

3. Rotate the **DIAL** knob to select **[1 FACTORY RE-SET]**, then press the **DIAL** knob.
"FACTORY RESET" appears on the LCD.

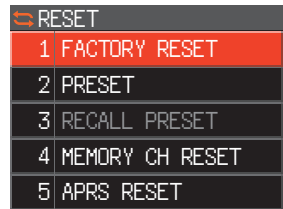

4. Rotate the **DIAL** knob to select **[OK]**.
To cancel the resetting, select **[CANCEL]**, then press the **DIAL** knob.
5. Press the **DIAL** knob to reset all.
After resetting all defaults, the call sign input message appears on the LCD. Set the call sign (page 21).

Memory Channels Reset

To erase only the registered all memory channels.

1. Press and hold the [**F(SETUP)**] key → select [**RESET**] → Press the **DIAL** knob → select [**4 MEMORY CH RESET**] → Press the **DIAL** knob.
“**MEMORY RESET**” appears on the LCD.
2. Rotate the **DIAL** knob to select [**OK**].
To cancel the resetting, select [**CANCEL**], then press the **DIAL** knob.
3. Press the **DIAL** knob to delete all memory contents.

APRS Reset

To restore all APRS settings to the factory defaults.

1. Press and hold the [**F(SETUP)**] key → select [**RESET**] → Press the **DIAL** knob → select [**5 APRS RESET**] → Press the **DIAL** knob.
“**APRS RESET**” appears on the LCD.
2. Rotate the **DIAL** knob to select [**OK**].
To cancel the resetting, select [**CANCEL**], then press the **DIAL** knob.
3. Press the **DIAL** knob to delete all **APRS** settings.

Text input screen

The keyboard screen is displayed when entering your own station call sign or memory channel tag.

● Character input method

1. Rotate the **DIAL** knob to select a character.
2. Press the **DIAL** knob to enter the selected character and move the cursor right to the text input area.
3. Repeat steps 1 and 2 to enter additional characters.
4. When input is complete, press and hold the **DIAL** knob to save the characters and return to normal operation.



- Select [**←**]/[**→**] key, then press the **DIAL** knob to move the cursor to left/right in the text input area.
- Select [**X**] key, then press the **DIAL** knob to erase the character at the left of the cursor position.
- Select [**Space**] key, then press the **DIAL** knob to enter a space at the cursor position.

Alphabet Input

- Rotate the **DIAL** knob to select [**A**] or [**ABC**], and each time the **DIAL** knob is pressed, the input screen changes as follows:
- Rotate the **DIAL** knob to select [**Caps**], and each time the **DIAL** knob is pressed, the input switches between small and capital letters.

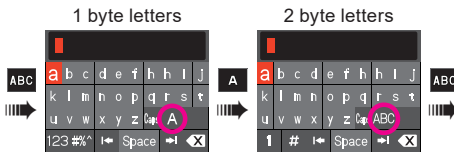

Numbers and Symbols Input

- Rotate the **DIAL** knob to select [**1**], [**#**], [**#%**] or [**123**], and each time the **DIAL** knob is pressed, the input screen changes as follows:

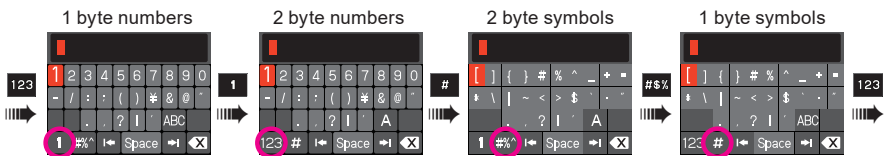

Specifications

● General

Frequency Range	: TX 144 - 148 MHz or 144 - 146 MHz 430 - 450 MHz or 430 - 440 MHz (Depends on the transceiver version)
	: RX 108 - 137 MHz (AIR Band) 137 - 174 MHz (144 MHz HAM / VHF Band) 174 - 400 MHz (GEN) 400 - 480 MHz (430 MHz HAM / UHF Band) 480 - 999.99 MHz (GEN) (USA Cellular Blocked)
Channel Steps	: 5 / 6.25 / 8.33 / 10 / 12.5 / 15 / 20 / 25 / 50 / 100 kHz (8.33 kHz: only for Air band)
Mode of Emission	: F1D, F2D, F3E, F7W
Frequency Stability	: ± 2.5 ppm (-4 °F to +140 °F [-20 °C to +60 °C])
Antenna Impedance	: 50 Ω
Supply Voltage	: Nominal 13.8 V DC, negative ground
Current Consumption (approx.)	: 0.5 A (Receive) 11 A (50 W TX, 144 MHz) 11 A (50 W TX, 430 MHz)
Operating Temperature Range	: -4 °F to +140 °F (-20 °C to +60 °C)
Case Size (W x H x D)	: Radio unit 5.47" x 1.66" x 5.2" (139 x 42 x 132 mm) (w/o Fan) Controller 5.47" x 2.09" x 0.7" (139 x 53 x 18 mm) (w/o Knob)
Weight (approx.)	: 2.43 lbs (1.1 kg) (with Radio Unit, Controller, Control Cable)

● Transmitter

RF Power Output	: 50 W / 25 W / 5 W
Modulation Type	: F1D, F2D, F3E: Variable Reactance Modulation F7W: 4FSK (C4FM)
Maximum Deviation	: ± 5 kHz
Spurious Emission	: At least 60 dB below
Microphone Impedance	: 2 k Ω
DATA Jack Impedance	: 10 k Ω

● Receiver

Circuit Type	: Double-Conversion Super heterodyne
Intermediate Frequency	: 1st: 58.05 MHz, 2nd: 450 kHz (A band) 1st: 57.15 MHz, 2nd: 450 kHz (B band)
Sensitivity	: 0.8 μ V TYP for 10dB SN (108 - 137MHz, @AM) 0.2 μ V for 12dB SINAD (137 - 140MHz, @FM) 0.2 μ V for 12dB SINAD (140 - 150MHz, @FM) 0.25 μ V for 12dB SINAD (150 - 174MHz, @FM) 0.3 μ V TYP for 12dB SINAD (174 - 222MHz, @FM) 0.25 μ V TYP for 12dB SINAD (222 - 300MHz, @FM) 0.8 μ V TYP for 10dB SINAD (300 - 336MHz, @AM) 0.25 μ V for 12dB SINAD (336 - 420 MHz, @FM) 0.2 μ V for 12dB SINAD (420 - 470 MHz, @FM) 0.2 μ V for 12dB SINAD (470 - 520MHz, @FM) 0.4 μ V TYP for 12dB SINAD (800 - 900MHz, @FM) 0.8 μ V TYP for 12dB SINAD (900 - 999.99MHz, @FM) 0.19 μ V TYP for BER 1% (Digital Mode) Cellular Blocked (USA only)
Selectivity (-6 dB/-60 dB)	: NFM, AM 12 kHz / 30 kHz
AF Output	: 3 W (8 Ω , THD10%, 13.8 V) Internal Speaker 3 W (8 Ω , THD10%, 13.8 V) External Speaker
AF Output Impedance	: 8 Ω
Strength of secondary radio waves	: 4 nW and below

● Bluetooth

Version	: Version 4.2
Class	: Class 2
Output Power	: 2 dBm

Specifications are subject to change without notice, and are guaranteed within the 144/430 MHz amateur bands only.

The Bluetooth® wordmark and logo are registered trademarks owned by Bluetooth SIG, Inc. and are used under license by Yaesu Musen Co., Ltd.

About internal spurious signals

Certain frequency combinations of signals received simultaneously, may cause some effect on the receiver mixer and IF circuits due to the high frequency of the internal oscillator. However, this is not a malfunction (refer to the calculation formulas below: n is any integer). Depending on the combination of the frequencies received at the same time, there may also be fluctuations in the receiver sensitivity.

- Reception frequency = 16 MHz x n times
- Reception frequency = 12 MHz x n times
- Reception frequency = 57.6 MHz x n times
- Reception frequency = 44 MHz x n times
- Reception frequency = 19.2 MHz x n times
- Upper (Band A) frequency = (Lower (Band B) frequency \pm 57.15 MHz) \times n times
- Lower (Band B) frequency = (Upper (Band A) frequency \pm 58.05 MHz) \times n times

YAESU LIMITED WARRANTY

Limited Warranty is valid only in the country/region where this product was originally purchased.

On-line Warranty Registration:

Thank you for buying YAESU products! We are confident your new radio will serve your needs for many years! Please register your product at www.yaesu.com - Owner's Corner

Warranty Terms:

Subject to the Limitations of the Warranty and the Warranty Procedures described below, YAESU MUSEN hereby warrants this product to be free of defects in materials and workmanship in normal use during the "Warranty Period." (the "Limited Warranty").

Limitations of Warranty:

- A. YAESU MUSEN is not liable for any express warranties except the Limited Warranty described above.
- B. The Limited Warranty is extended only to the original end-use purchaser or the person receiving this product as a gift, and shall not be extended to any other person or transferee.
- C. Unless a different warranty period is stated with this YAESU product, the Warranty Period is three years from the date of retail purchase by the original end-use purchaser.
- D. The Limited Warranty is valid only in the country/region where this product was originally purchased.
- E. During the Warranty Period, YAESU MUSEN will, at its sole option, repair or replace (using new or refurbished replacement parts) any defective parts within a reasonable period of time and free of charge.
- F. The Limited Warranty does not cover shipping cost (including transportation and insurance) from you to us, or any import fees, duties or taxes.
- G. The Limited Warranty does not cover any impairment caused by tampering, misuse, failure to follow instructions supplied with the product, unauthorized modifications, or damage to this product for any reasons, such as: accident; excess moisture; lightning; power surges; connection to improper voltage supply; damage caused by inadequate packing or shipping procedures; loss of, damage to or corruption of stored data; product modification to enable operation in another country/purpose other than the country/purpose for which it was designed, manufactured, approved and/or authorized; or the repair of products damaged by these modifications.
- H. The Limited Warranty applies only to the product as it existed at the time of the original purchase, by the original retail purchaser, and shall not preclude YAESU MUSEN from later making any changes in design, adding to, or otherwise improving subsequent versions of this product, or impose upon YAESU MUSEN any obligation to modify or alter this product to conform to such changes, or improvements.
- I. YAESU MUSEN assumes no responsibility for any consequential damages caused by, or arising out of, any such defect in materials or workmanship.
- J. TO THE FULLEST EXTENT PERMITTED BY LAW, YAESU MUSEN SHALL NOT BE RESPONSIBLE FOR ANY IMPLIED WARRANTY WITH RESPECT TO THIS PRODUCT.
- K. If the original retail purchaser timely complies with the Warranty Procedures described below, and YAESU MUSEN elects to send the purchaser a replacement product rather than repair the "original product", then the Limited Warranty shall apply to the replacement product only for the remainder of the original product Warranty Period.
- L. Warranty statutes vary from state to state, or country to country, so some of the above limitations may not apply to your location.

Warranty Procedures:

1. To find the Authorized YAESU Service Center in your country/region, visit www.yaesu.com. Contact the YAESU Service Center for specific return and shipping instructions, or contact an authorized YAESU dealer/distributor from whom the product was originally purchased.
2. Include proof of original purchase from an authorized YAESU dealer/distributor, and ship the product, freight prepaid, to the address provided by the YAESU Service Center in your country/region.
3. Upon receipt of this product, returned in accordance with the procedures described above, by the YAESU Authorized Service Center, all reasonable efforts will be expended by YAESU MUSEN to cause this product to conform to its original specifications. YAESU MUSEN will return the repaired product (or a replacement product) free of charge to the original purchaser. The decision to repair or replace this product is the sole discretion of YAESU MUSEN.

Other conditions:

YAESU MUSEN'S MAXIMUM LIABILITY SHALL NOT EXCEED THE ACTUAL PURCHASE PRICE PAID FOR THE PRODUCT. IN NO EVENT SHALL YAESU MUSEN BE LIABLE FOR LOSS OF, DAMAGE TO OR CORRUPTION OF STORED DATA, OR FOR SPECIAL, INCIDENTAL, CONSEQUENTIAL, OR INDIRECT DAMAGES, HOW EVER CAUSED; INCLUDING WITHOUT LIMITATION TO THE REPLACEMENT OF EQUIPMENT AND PROPERTY, AND ANY COSTS OF RECOVERING, PROGRAMMING OR REPRODUCING ANY PROGRAM OR DATA STORED IN OR USED WITH THE YAESU PRODUCT.

Some Countries in Europe and some States of the USA do not allow the exclusion or limitation of incidental or consequential damages, or a limitation on how long an implied warranty lasts, so the above limitation or exclusions may not apply. This warranty provides specific rights, there may be other rights available which may vary between countries in Europe or from state to state within the USA.

This Limited Warranty is void if the label bearing the serial number has been removed or defaced.

Changes or modifications to this device that are not expressly approved by YAESU MUSEN could void the user's authorization to operate this device.

This device complies with part 15 of the FCC Rules. Operation is subject to the following two conditions: (1) This device may not cause harmful interference, and (2) this device must accept any interference including received, interference that may cause undesired operation.

The scanning receiver in this equipment is incapable of tuning, or readily being altered, by the User to operate within the frequency bands allocated to the Domestic public Cellular Telecommunications Service in Part 22.

The YAESU MUSEN is not responsible for any changes or modifications not expressly approved by the party responsible for compliance. Such modifications could void the user's authority to operate the equipment.

This device complies with ISED's applicable license-exempt RSS standard(s). Operation is subject to the following two conditions: (1) this device may not cause interference, and (2) this device must accept any interference, including interference that may cause undesired operation of the device.

Le présent appareil est conforme aux CNR d'Industrie Canada applicables aux appareils radio exempts de licence. L'exploitation est autorisée aux deux conditions suivantes : (1) l'appareil ne doit pas produire de brouillage, et (2) l'utilisateur de l'appareil doit accepter tout brouillage radioélectrique subi, même si le brouillage est susceptible d'en compromettre le fonctionnement.

DECLARATION BY MANUFACTURER

The Scanner receiver is not a digital scanner and is incapable of being converted or modified to a digital scanner receiver by any user.

WARNING: MODIFICATION OF THIS DEVICE TO RECEIVE CELLULAR RADIOTELEPHONE SERVICE SIGNALS IS PROHIBITED UNDER FCC RULES AND FEDERAL LAW.

CAN ICES-3 (B) / NMB-3 (B)

This equipment has been tested and found to comply with the limits for a Class B digital device, pursuant to part 15 of the FCC Rules. These limits are designed to provide reasonable protection against harmful interference in a residential installation. This equipment generates, uses, and can radiate radio frequency energy; and, if not installed and used in accordance with the instructions, may cause harmful interference to radio communications. However, there is no guarantee that interference will not occur in a particular installation.

If this equipment does cause harmful interference to radio or television reception, which can be determined by turning the equipment off and on, the user is encouraged to try to correct the interference by one or more of the following measures:

- Reorient or relocate the receiving antenna.
- Increase the separation between the equipment and receiver.
- Connect the equipment into an outlet on a circuit different from that to which the receiver is connected.
- Consult the dealer or an experienced radio/TV technician for help.

This equipment complies with FCC/IC radiation exposure limits and meets the FCC radio frequency (RF) Exposure Guidelines and RSS-102 of the IC radio frequency (RF) Exposure rules. This equipment has very low levels of RF energy that is deemed to comply without testing of specific absorption rate (SAR).

This transmitter must not be co-located or operated in conjunction with any other antenna or transmitter.

YAESU

Declaration of Conformity

Type of Equipment:	144/430MHz Digital/Analog Transceiver
Brand Name:	YAESU
Model Number:	FTM-300DR
Manufacturer:	YAESU MUSEN CO., LTD.
Address of Manufacturer:	Tennozu Parkside Building, 2-5-8 Higashi-Shinagawa, Shinagawa-ku, Tokyo 140-0002 Japan

This device complies with part 15 of the FCC Rules. Operation is subject to the following two conditions; (1) this device may not cause harmful interference, and (2) this device must accept any interference received, including interference that may cause undesired operation.

The technical documentation as required by the Conformity Assessment procedures is kept at the following address:

Company: Yaesu U.S.A.

Address: 6125 Phyllis Drive, Cypress, CA 90630, U.S.A.

Telephone: (714) 827-7600

EU Declaration of Conformity

We, Yaesu Musen Co. Ltd of Tokyo, Japan, hereby declare that this radio equipment FTM-300DE is in full compliance with EU Radio Equipment Directive 2014/53/EU. The full text of the Declaration of Conformity for this product is available to view at <http://www.yaesu.com/jp/red>

ATTENTION – Condition of use

This transceiver operates on frequencies that are regulated. Use of the Transmitter in the EU countries shown in the accompanying table is not permitted without authorization. Users should consult their local spectrum management authority for licensing conditions applicable to this equipment.

					
AT	BE	BG	CY	CZ	DE
DK	ES	EE	FI	FR	UK
EL	HR	HU	IE	IT	LT
LU	LV	MT	NL	PL	PT
RO	SK	SI	SE	CH	IS
LI	NO	–	–	–	–

Disposal of Electronic and Electrical Equipment

Products with the symbol (crossed-out wheeled bin) cannot be disposed as household waste.

Electronic and Electrical Equipment should be recycled at a facility capable of handling these items and their waste by-products.

Please contact a local equipment supplier representative or service center for information about the waste collection system in your country.



YAESU

The radio

Copyright 2020
YAESU MUSEN CO., LTD.
All rights reserved.

No portion of this manual may be
reproduced without the permission of
YAESU MUSEN CO., LTD.

YAESU MUSEN CO., LTD.

Tennozu Parkside Building
2-5-8 Higashi-Shinagawa, Shinagawa-ku, Tokyo 140-0002 Japan

YAESU USA

6125 Phyllis Drive, Cypress, CA 90630, U.S.A.

YAESU UK

Unit 12, Sun Valley Business Park, Winnall Close
Winchester, Hampshire, SO23 0LB, U.K.

2005V-BC
Printed in China

