



# MOBILE PoC RADIO

## TM-9 USER GUIDE

Please read this instruction book carefully before using.

[www.inricosolutions.com](http://www.inricosolutions.com)

## **Disclaimer**

This guide is for reference only and the information in this document is carefully examined, and is believed to be entirely reliable. However, no responsibility is assumed for inaccuracies. Furthermore, Inrico reserves the right to make changes to any products herein to improve readability, function, or design. Inrico does not assume any liability arising out of the applications or use of any product or circuit described herein; nor does it cover any license under its patent rights, nor the rights of others.

## **Contents**

**Unboxing and Device Checking**

**Handling Precautions**

**Product Overview**

**Accessories Installation**

**Basic Functions**

**LED Indicators**

**Operating Instructions**

**Basic Troubleshooting**

**Specification**

# Unpacking and Device Checking

Please unbox and take out the device and all accessories carefully, and ensure all lists have been gotten before discarding the cardboard box. If any items are lost or damaged in transit, please contact with our distributors.

<b>Name</b>	<b>Quantity</b>
Mobile Radio	1
Power Cord	1
Touchscreen Pen	1
Main Antenna	1
GPS Antenna	1
Fixed Bracket	1
Bracket	2
User Manuel	1
Fixing Screw Pack	1
Bracket Locking Screw	1
Screwdriver	1

## Handling Precautions

Please read the following content carefully. It is very important for device users to gain general knowledge and risks.

### Operating Voltage

Please use within the specified voltage range (12V or 24V).

Car Type	Abnormal	Normal Range Before Starting	Normal Range During Working
12V	<11.9V or >14.8V	11.6V-12.8V	11.6V-14.8V
24V	<23.6V or >27.2V	23.2V-25.6V	23.2V-27.2V

### Flammable and Explosive Area

Do not operate the product in a location containing fuels, chemicals, explosive atmospheres and other flammable or explosive materials.

### Operating Prohibitions

- Do not use the device in any hazardous areas such as gas, dust, steam, etc.
- Please turn off the device while refueling or parking at the gas station.
- Avoid prolonged time in the sun or placing it near heating appliance.
- Avoid excessive exposure to the extreme dusty, damp and splashing place, or leave it on unstable surface.
- Do not place the device near heat sources or fire sources such as electric heaters, microwave ovens, ovens, water heaters, stoves, candles, or other places that may generate high temperatures.
- Do not use the device during thunderstorms, which may cause equipment failure or electric shock.
- Do not install the radio in a place where human skin can touch the base. High temperature may burn skins.
- When the product is working, do not touch its hot metal shell to avoid burn.
- Do not adjust the product during driving and pay attention to road conditions. Pull off the road and park properly when necessary.
- Reparation by professional technicians, do not disassemble by yourself.

### Accessories Requirement

- Do not use any unapproved, damaged accessories or incompatible power source, which

may cause fire, explosion or other hazards.

- Please approved accessories only. It will violate the warranty clause if using other unproved accessories and causing accidental damage.

### Maintenance

- Before cleaning and maintaining the device: please stop running, turn off, and disconnect all connections with other equipment.
- When you do not use the mobile radio, please cover the accessories connector.
- When cleaning the dust, please use soft brush and neutral detergent (no strong corrosive chemicals) to wipe it.
- Please keep the equipment and accessories dry.
- Please do not use the microwave oven or hair dryer or other heating devices for dry them.

### Product Overview

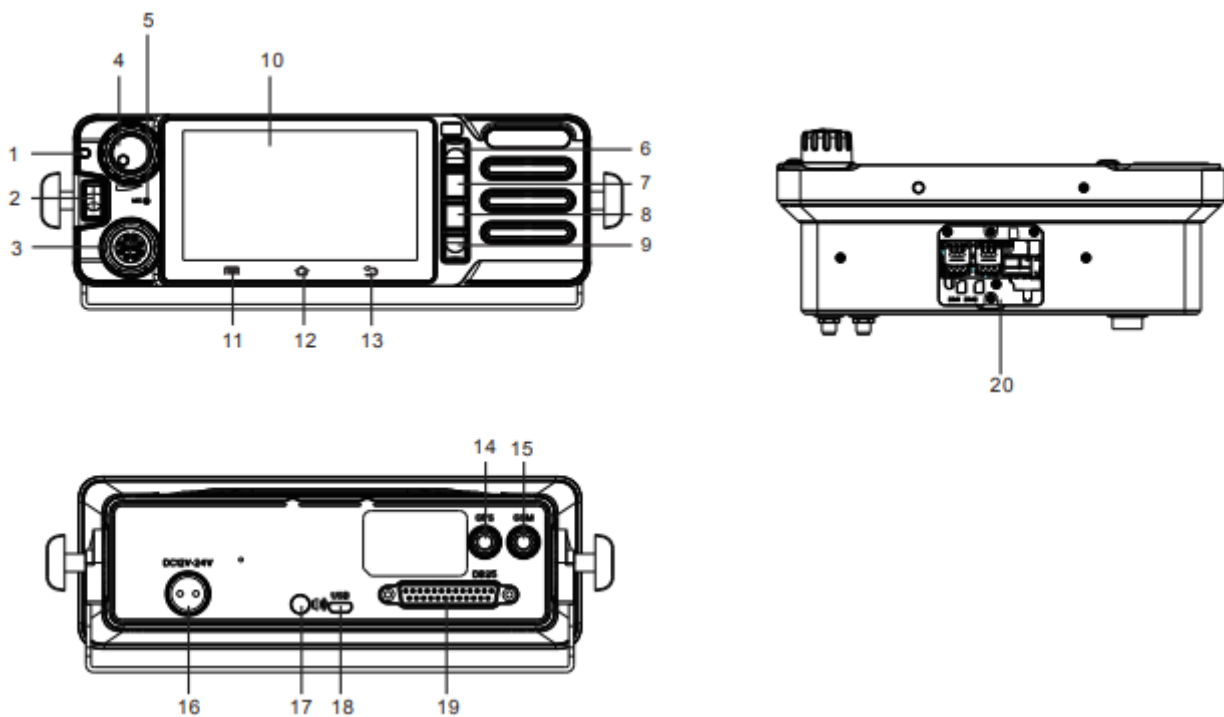

1	LED Indicator	Color and flash times to transmit corresponding signals
2	SOS Button	Long press 2S to trigger an alarm
3	Aviation Connector	Support speaker microphone, PTT device
4	Power /Volume Knob	Rotate clockwise to power up and increase the volume, anticlockwise to decrease the volume and turn off.
5	Front MIC	In front of the radio

6	OK	Confirm button
7	P1 Programmable Button	
8	P2 Programmable Button	
9	P3 Programmable Button	
10	LCD Screen	4"OLED, 360*640*RGE
11	Menu Button	
12	Home Button	
13	Return/Exit	Return to previous function list or exit
14	GPS Antenna Connector	
15	GSM Antenna Connector	
16	Aviation Power Connector	
17	3.5mm Audio Connector	Connecting audio input equipment to transmit analog audio signals and amplifiers dual channel stereo signals
18	USB Interface	Upgrade, download, turn on the radio when connect power
19	D25 Interface	
20	SIM-TF Card	SIM card and TF card slot

## Accessories Installation

### 1. Insert SIM and TF Card

Insert SIM and TF card to the slot, close the cover and tighten the screws.

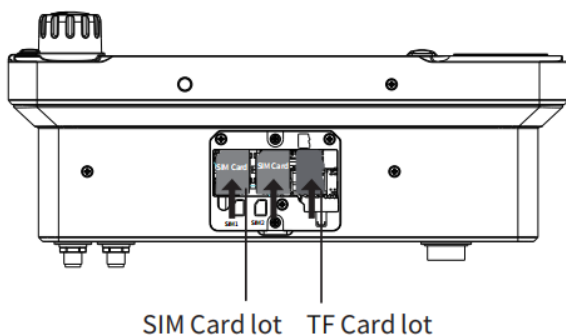

### 2. Attaching the Bracket

- Rotate clockwise and tighten it.
- Rotate counterclockwise to remove it.

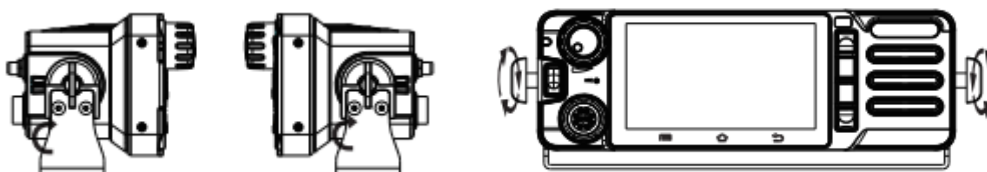

### 3. Plug in DB25

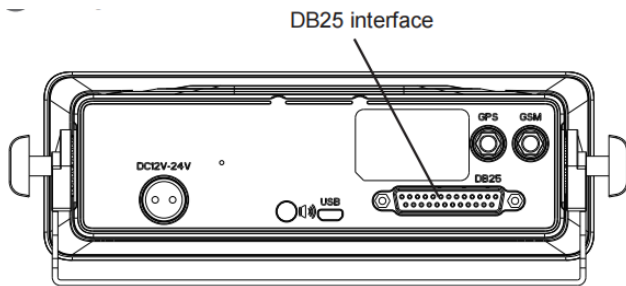

#### 4. Attaching the Antennas- GPS Antenna/ GSM Antenna

Rotate clockwise until it is tightened, paying attention to the corresponding direction.

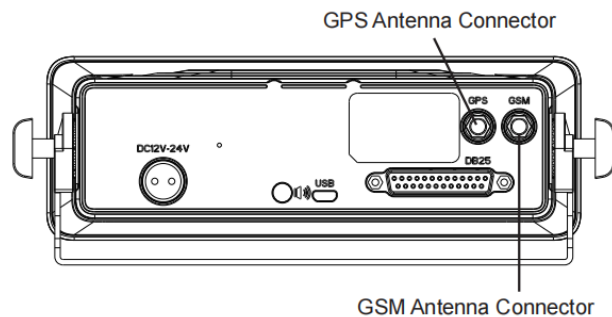

#### 5. Attaching the Palm Microphone

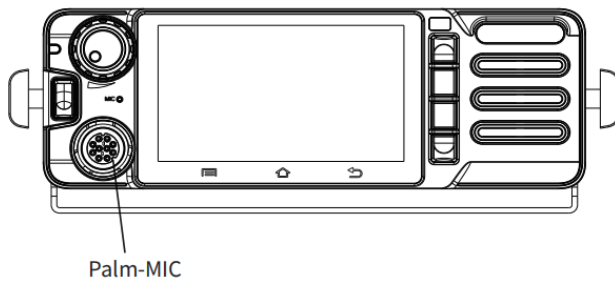

## Basic Functions

### 1. Powering Up the Device

Make sure that the power connector is plugged in properly. Rotate the Power/Volume Knob to power up,

### 2. Prompt Bar

Press on the top of the screen, select the drop-down menu and drag down to open.

The prompt bar displays the operating applications. Click on the running list bar and quickly switch to the corresponding application.

Friendly Note: No network in flight mode. In addition, the prompt bar still displays the current notifications (like unread text messages, etc), and running applications. Click the icon to view

list. Click quickly  to enable corresponding function.

### 3. Message

Click "Message", received messages will be displayed, and you can edit, send, and delete.

#### **4. Setting**

Set and view related system functions and status.

Wireless & Networks: WIFI, Bluetooth, SIM card data usage and more.

Device: Display, Notifications, Sound, Apps, Storage, Memory.

Personal: Location, Security, Accounts, Google, Language, Backup & Reset.

System: Date & Time, Printing, About phone (click the "Build number" continuously to open the developer option).

#### **5. Personalization Settings**

Long press any blank space of the main screen to access to personalized settings interface.

You can set wallpaper, add widgets, and the system.

#### **6. Icon Removal**

Long press the menu in the screen or widget icon, move or delete corresponding icons.

#### **7. Factory Reset**

Select "Backup & Reset" in the settings menu, and then restore factory settings.

Warning: Restoring the phone to initial factory state, which means clearing the system, application data and settings, and downloaded applications.

#### **8. Contact List**

Open contact list to add or import contacts, tap the icon  in the lower right corner to add also.

#### **9. Phones**

Make a phone call or view the calling records.

#### **10. Gallery**

Click to enter the gallery interface to view pictures and videos in the radio.

#### **11. Map**

Click to view the current location, real-time road conditions, bus routes, cycling routes, satellite images, terrain and other information. It also supports navigation and location sharing.

#### **12. Download**

Click to view the downloaded files and messages in the radio.

#### **13. Google Play**

After connecting network, log into Google account and enter the play store interface. You can download a variety of applications in the Play store, including games, software, books, education, etc.

#### **14. File Management**

Click to view the file information stored in the mobile radio. If inserting an SD card, you can view the file information in the SD card.



## 15. MIC and Palm-MIC

When connect Palm-MIC, the body MIC will be shielded and unavailable.

## 16. USB Data Cable and DB25 Connector

When insert USB data cable, the DB25 will be shielded and unavailable

## Status Indicators

The indicators could be customized according to the APP. The following is the default indicator status of Inrico APP.

LED Indicator	Working Status	Remark
Solid Red	The device is transmitting.	
	SOS starts	
Solid Green	The device is calling.	

## Operation Interface

### 1. Input Account and Password

The user configure IP address according to the platform server and then login.

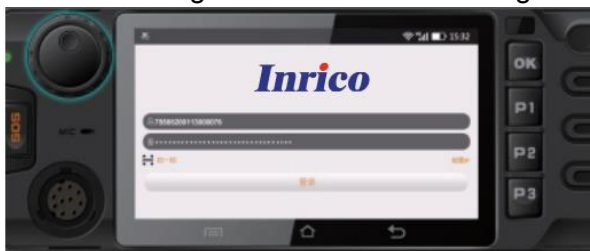

### 2. Communication

① Select the contact or group, press PPT button of the palm-mic to talk.

Red light for sending messages



② Release PTT to end the call



### ③Receive Message

Green light for receiving messages



### 3. Volume Adjustment

The radio volume can be adjusted by volume knob.



### 4. Emergency Operation

Press SOS button for 2 seconds to alarm automatically (Defined via APP).



### 5. Exit

Press return button to exit and be back to the main interface.



## Network Connecting

### 1. WIFI Connecting

Turn on the device, click “Settings ” → WIFI. Select the wireless network and enter the

password to connect.

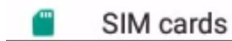
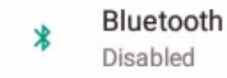
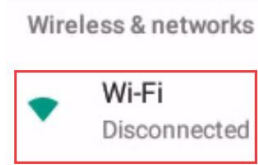
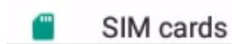
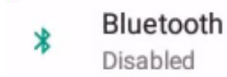
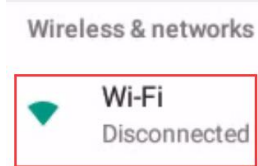
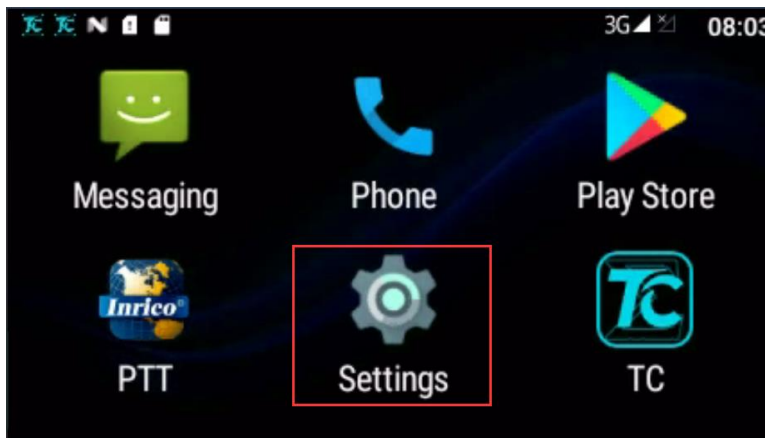

## 2. Cellular Network Connecting

Open "Settings", tap on 'SIM Cards', select the one that you need to connect.

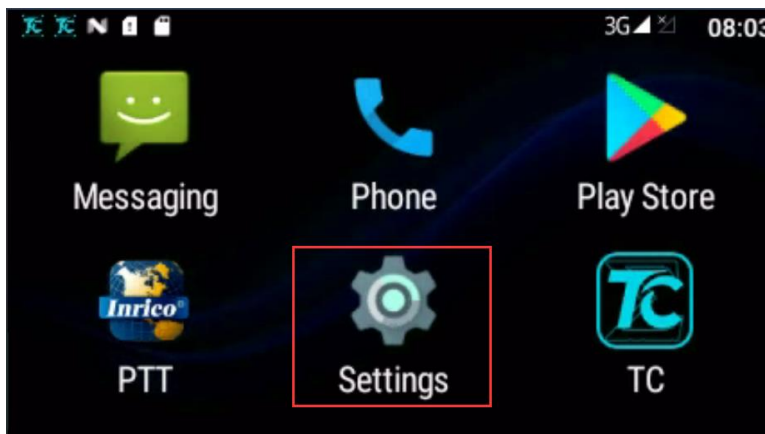

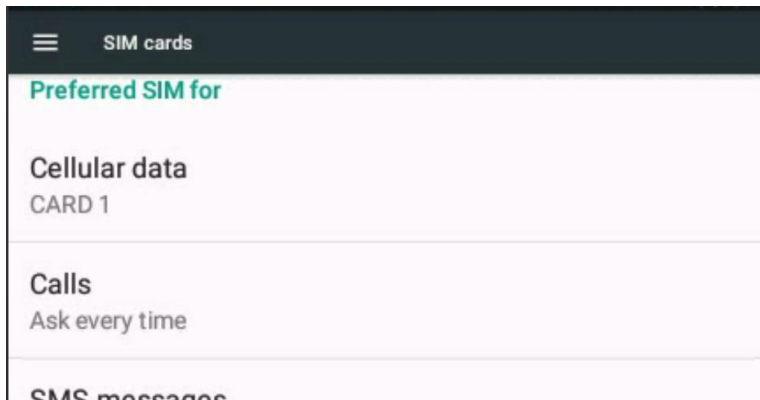
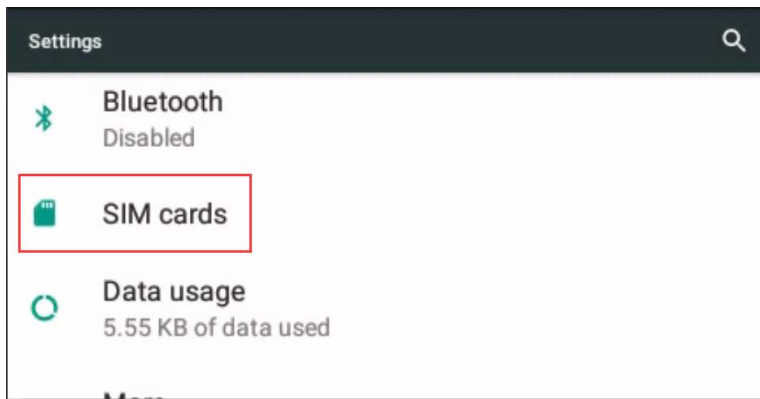

### 3. Stop Running Non-systematic APP

Select "Settings" → Apps → Confirm the APP required → FORCE STOP

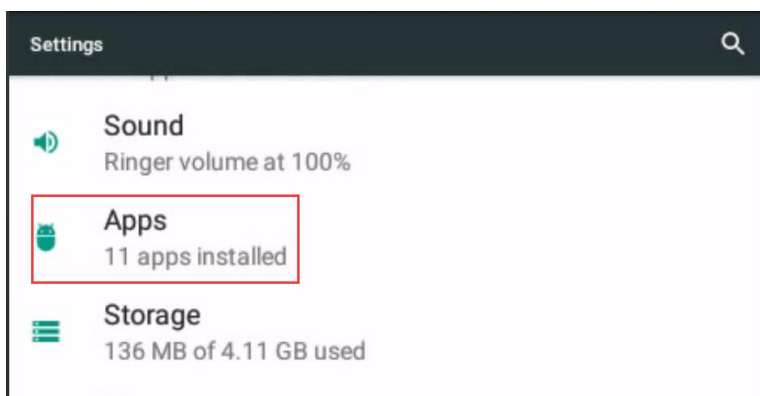
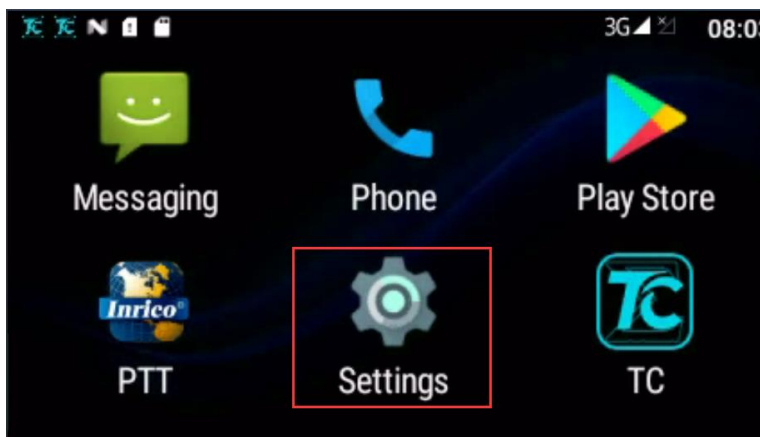

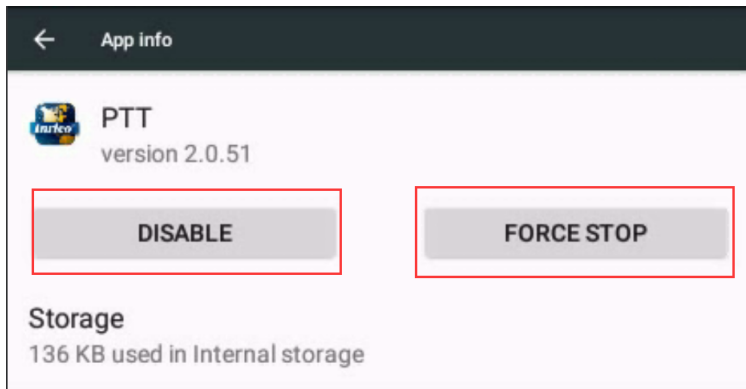

## Basic Troubleshooting

If your device shows following problem during operating, please check the instruction as below.  
 If problems can't be solved, please contact local authorized service.

Problems	Solutions
<b>Terminal Crash</b>	Too much APPS on processing. - Force some programs to quit or restart the terminal.
<b>Buttons Not Working</b>	The buttons may not work temporarily, restart the terminal.
	The buttons is broken, contact the dealer or our company.
<b>White Screen Error</b>	Display screen may not work temporarily, restart the device.
	The display screen is damaged, contact the dealer or our company.
<b>Echo or Noise During Connecting</b>	The signal may be weak, make sure the terminal is within network coverage. - Restart the device and it'll automatically search for better available network.
	The speaker may be covered, clean the speaker surface.
<b>Unable to Locate</b>	The signal is weak and the device can't receive the signal. - Move to open and flat area and try again.
<b>Unable to Detect SIM Card</b>	The SIM card may be incorrectly installed. - Remove and re-insert the SIM card.

	<p>The SIM card may be not working due to dirt or damage.</p> <ul style="list-style-type: none"> <li>- Clean the electrical contact or replace it.</li> </ul>
<b>Can't Connect to Network</b>	<p>The SIM card cannot work properly or cannot be used.</p> <ul style="list-style-type: none"> <li>- Make sure the SIM card has a balance instead of arrears.</li> </ul>
	<p>The mobile network not available.</p> <ul style="list-style-type: none"> <li>- Select SIM card network, and contact the operator to activate the cellular network.</li> </ul>
	<p>In areas with poor signal, out of network service, or SIM card is not effective.</p> <ul style="list-style-type: none"> <li>- Remove the SIM cards, and reinsert them properly, or change another one. Move to somewhere with better network signal or go to the window if you are in the building.</li> </ul>

## Specification

<b>OS</b>	Android 7.0
<b>EU Version</b>	GSM: B2/B3/B5/B8 WCDMA: B1/B5/B8
<b>Frequency</b>	FDD-LTE: B1/B3/B5/B7/B8/B20/B28A//B28B TDD-LTE: B38/B40/B41
<b>US Version</b>	GSM: B2/B3/B5/B8 WCDMA: B2/B4/B5 FDD-LTE: B2/B3/B4/B5/B7/B8/B12/B17/B28A/B28B/B66 TDD-LTE: B38/B40
<b>Support</b>	WIFI/ BT/ GPS
<b>CPU</b>	MTK6739
<b>Memory</b>	1GB(RAM, DDR3)+ 8GB(ROM)
<b>Working Voltage</b>	12 or 24V
<b>Display</b>	4" OLED, 360*640RGB
<b>Dimension (H*W*D)</b>	196*63*89mm
<b>Weight</b>	≈500g

**Working Temperature** -20°C ~ 60°C

**Storage Temperature** -40°C ~ 70°C